

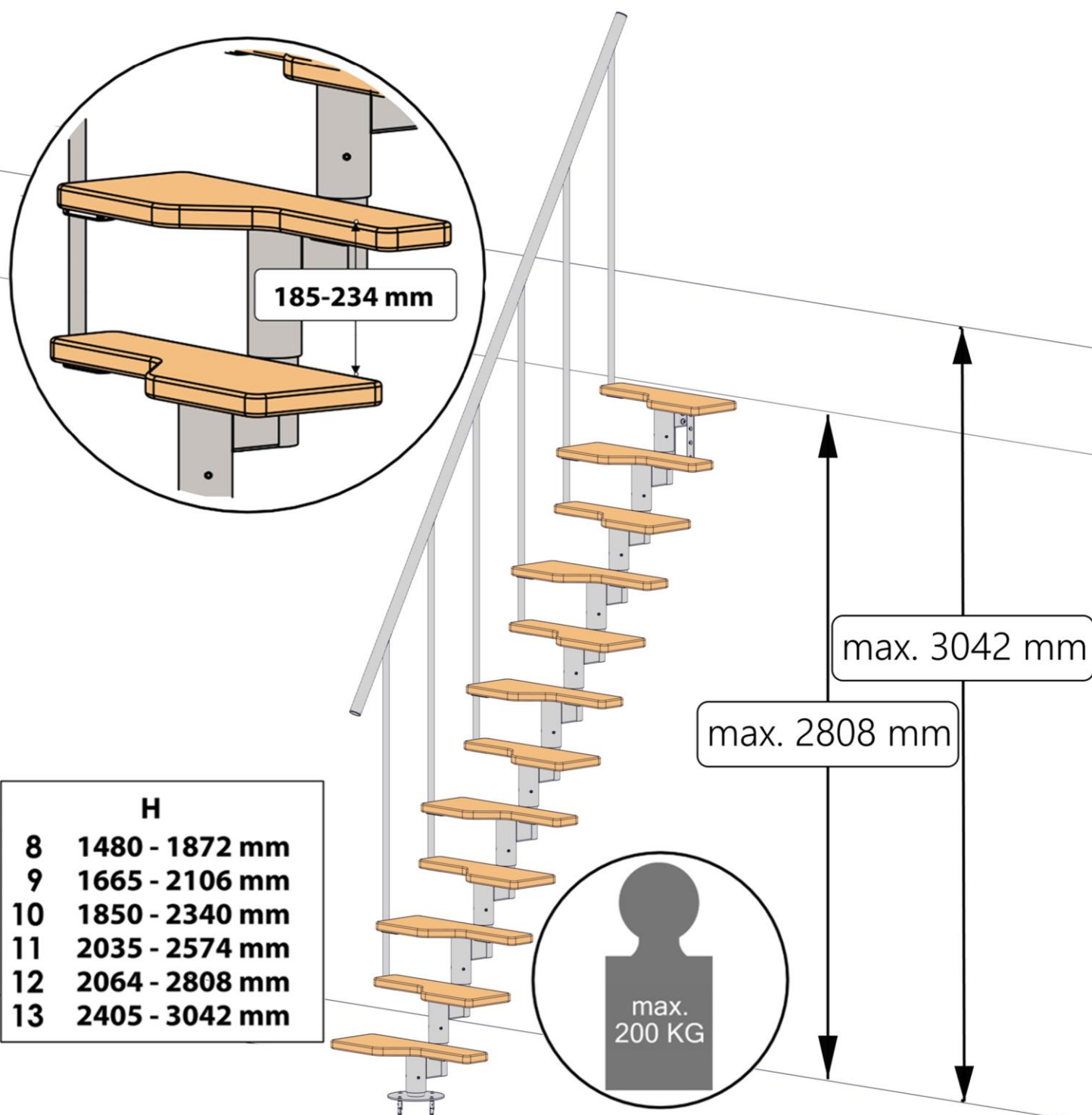

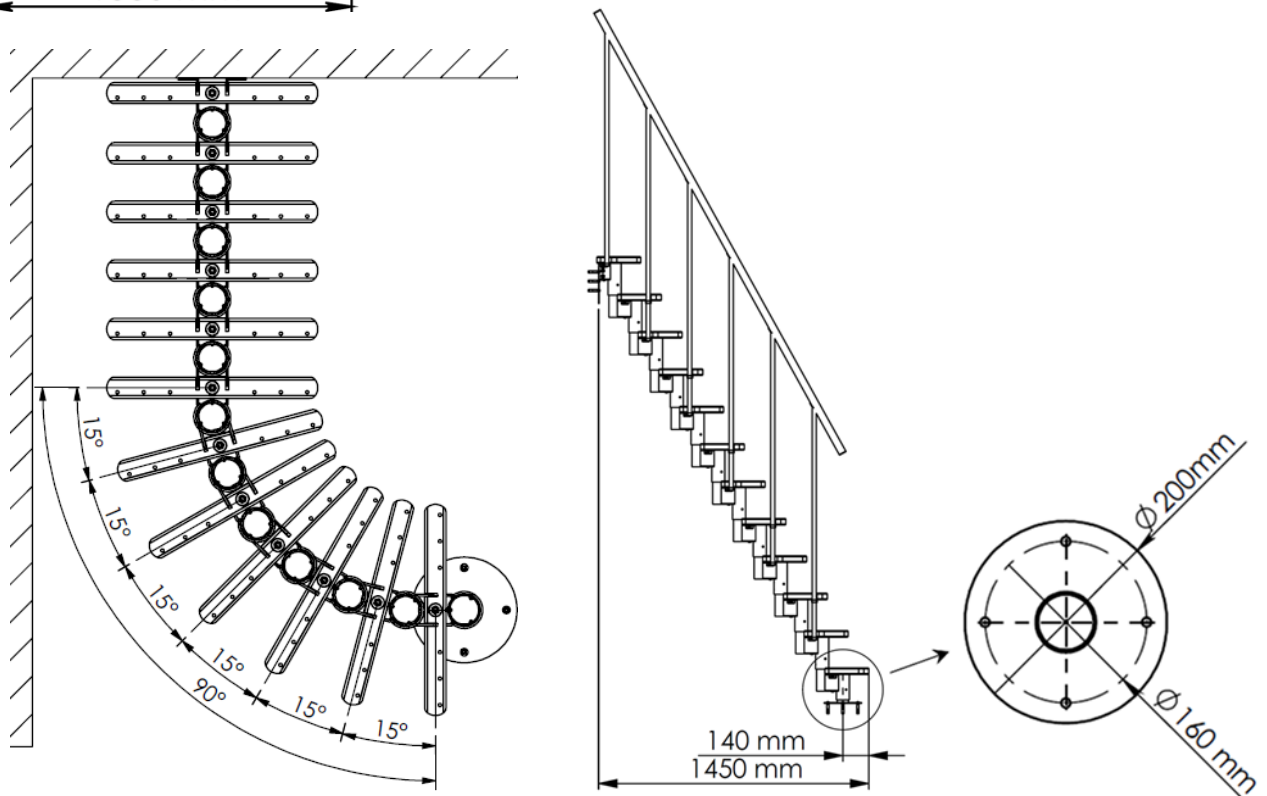

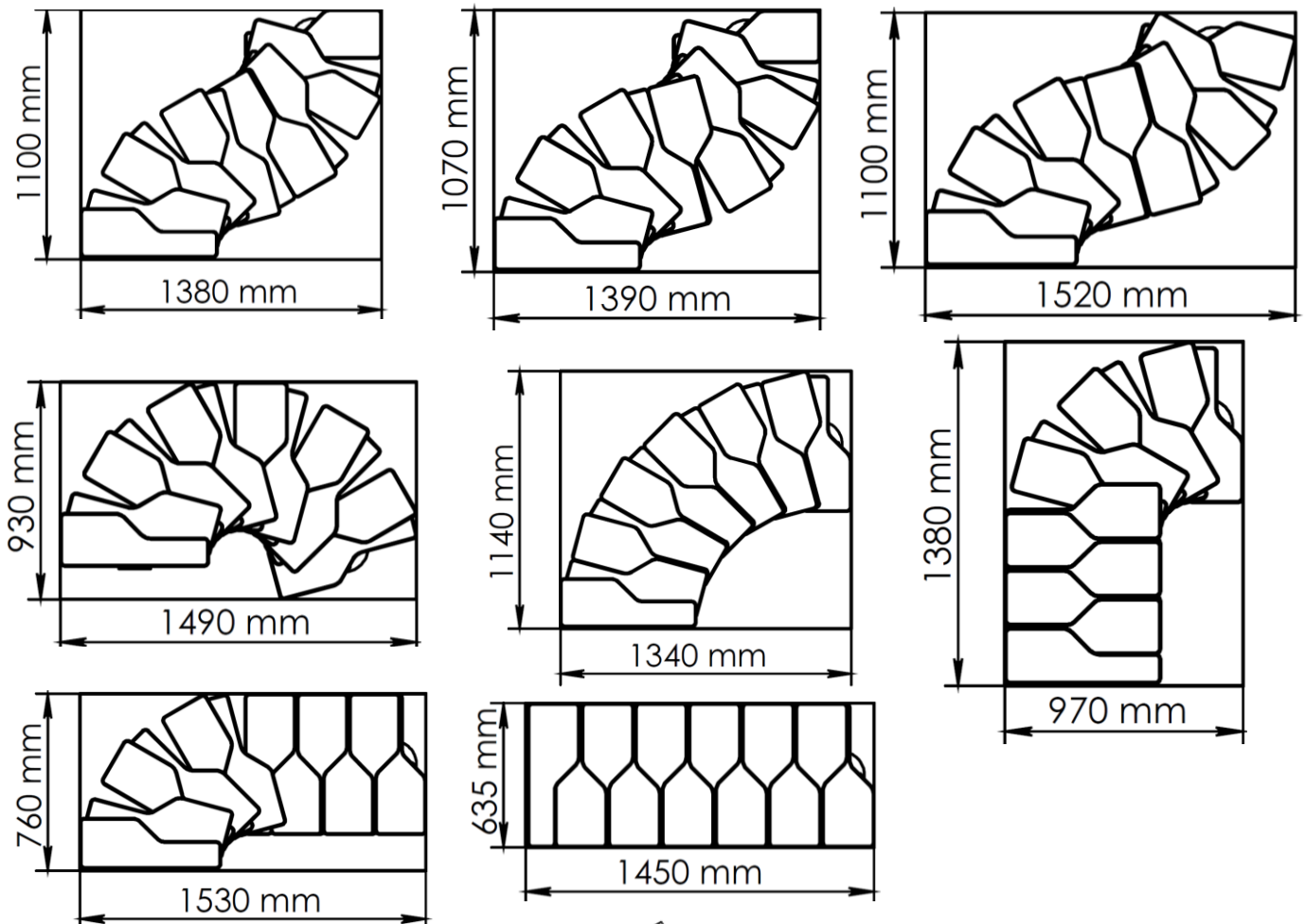





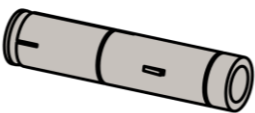

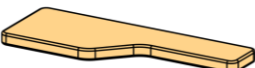
VIENNA

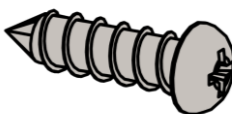

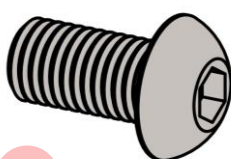
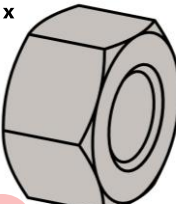
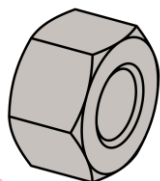
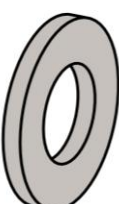
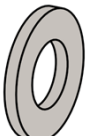
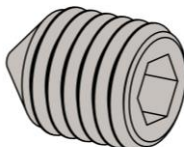
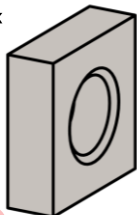
VIENNA

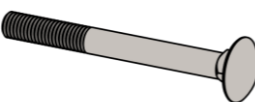
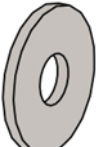

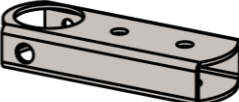
VIENNA

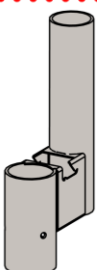
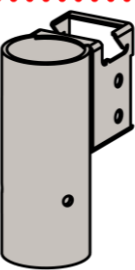
<p>10 x</p>  <p>D01 M8x55 mm</p>	<p>10 x</p>  <p>GS11 Ø22x2x1260mm</p>	<p>1 x</p>  <p>G02 Ø40x3,5x4000mm</p>	<p>12 x</p>  <p>HS09</p>
<p>10 x</p>  <p>KS01 Ø22mm</p>	<p>2 x</p>  <p>KS02 Ø40mm</p>	<p>112 x</p>  <p>NT06 Ø5x30mm</p>	<p>20 x</p>  <p>NT11 Ø4x25mm</p>
<p>4 x</p>  <p>NT18 M10x20mm</p>	<p>4 x</p>  <p>NT22 M10</p>	<p>12 x</p>  <p>NT24 M8</p>	<p>8 x</p>  <p>NT25 M10 DIN125A</p>
<p>10 x</p>  <p>NT26 M8 DIN125A</p>	<p>20 x</p>  <p>NT30 M5x6mm DIN914</p>	<p>20 x</p>  <p>NT31 M5 DIN562</p>	<p>48 x</p>  <p>NT32 M10x8mm DIN914</p>
<p>12 x</p>  <p>NT35 M8x80mm ISO8677</p>	<p>12 x</p>  <p>NT37 M8 DIN9021</p>	<p>10 x</p>  <p>NT47 M8x60mm ISO7380-1</p>	<p>20 x</p>  <p>ST22</p>
<p>10 x</p>  <p>ST31</p>	<p>12 x</p>  <p>ST32</p>	<p>1 x</p>  <p>ST33</p>	<p>1 x</p>  <p>ST34</p>

VIENNA

1 x

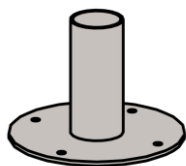

ST35

1 x



ST166a

1 x



ST166b

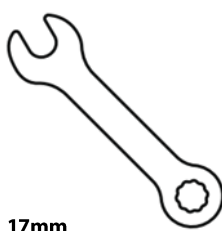

17mm

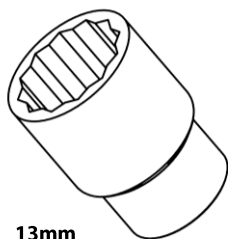

13mm

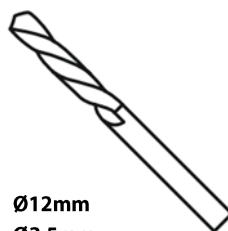

Ø12mm
Ø3.5mm

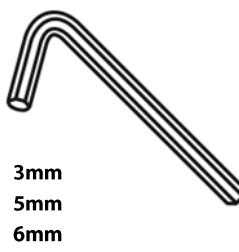
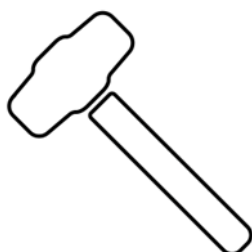

3mm
5mm
6mm

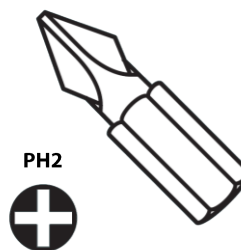

PH2

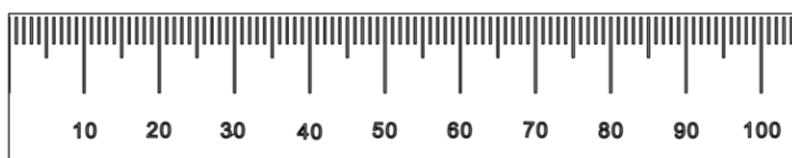
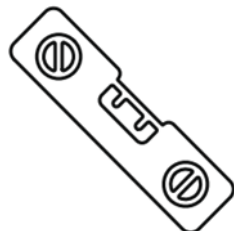

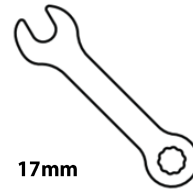
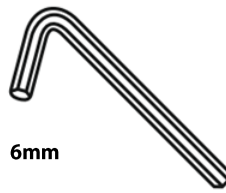

1

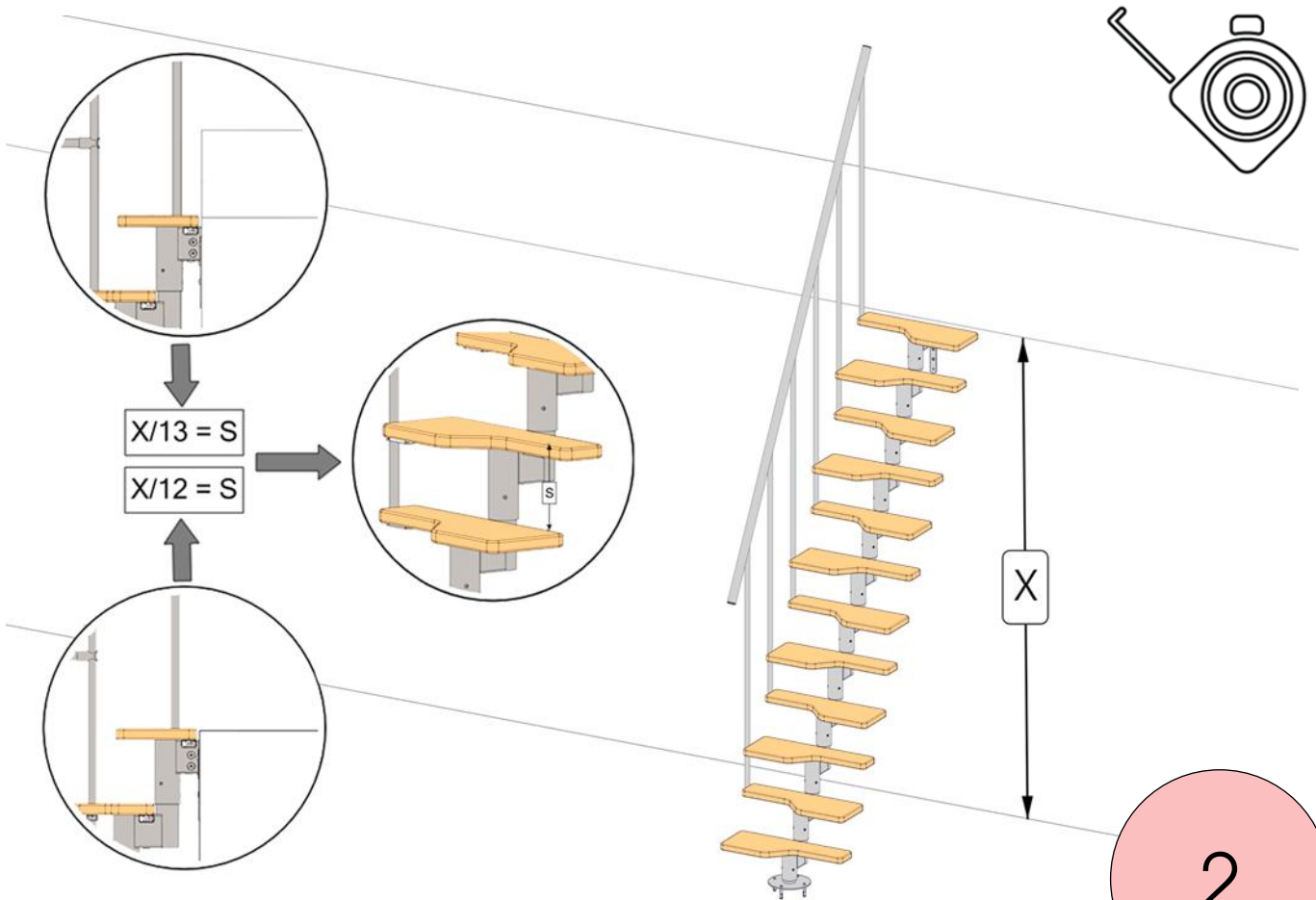
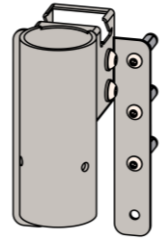
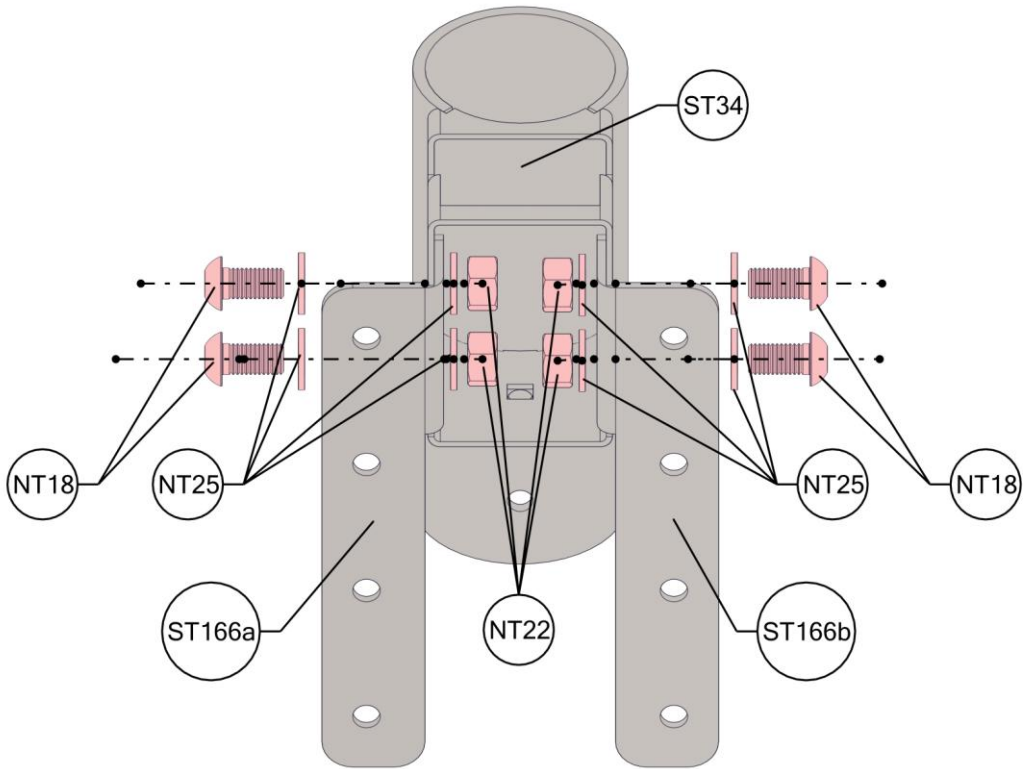

2

3

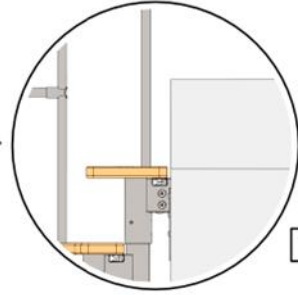
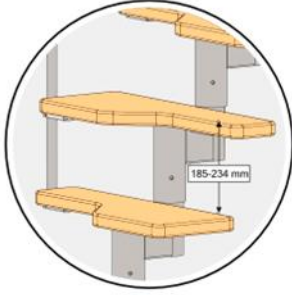
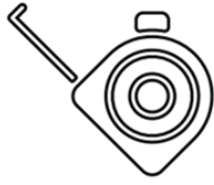

13xS: (185mm ↔ 234mm) + 35mm

12xS:35mm

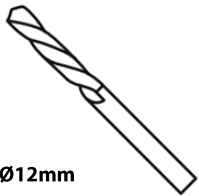
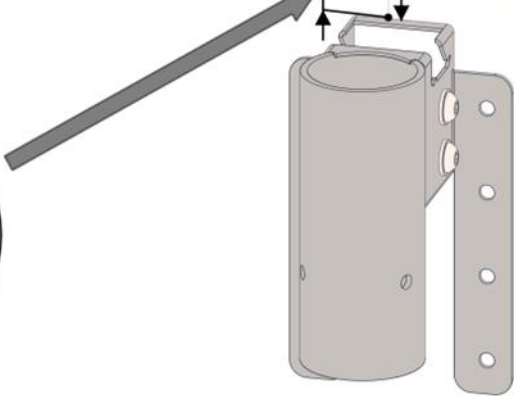
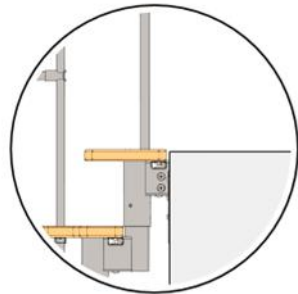

Ø12mm

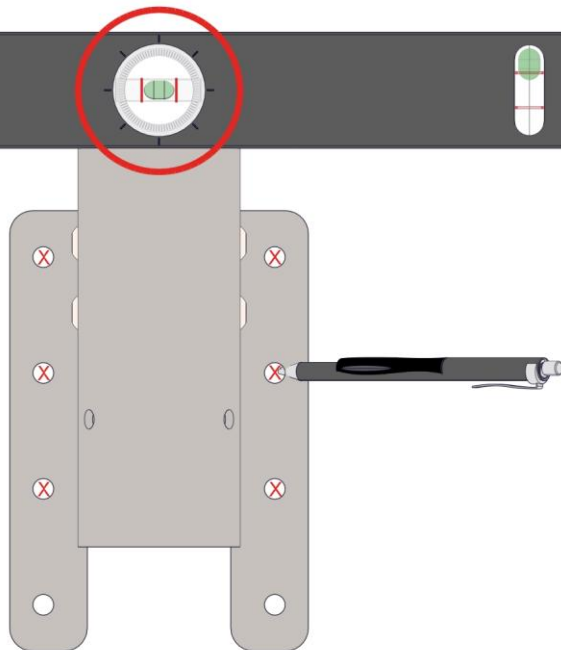
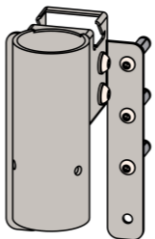
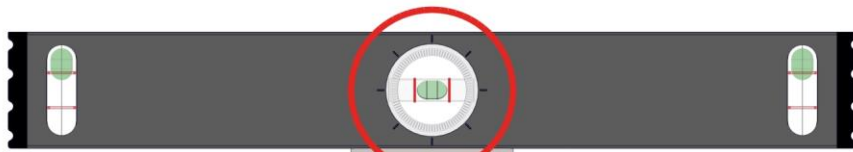
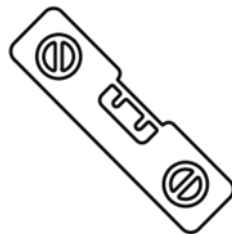

4

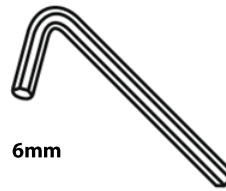

6mm

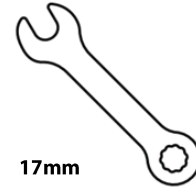

17mm

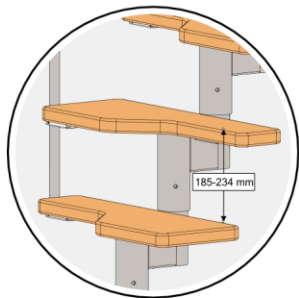
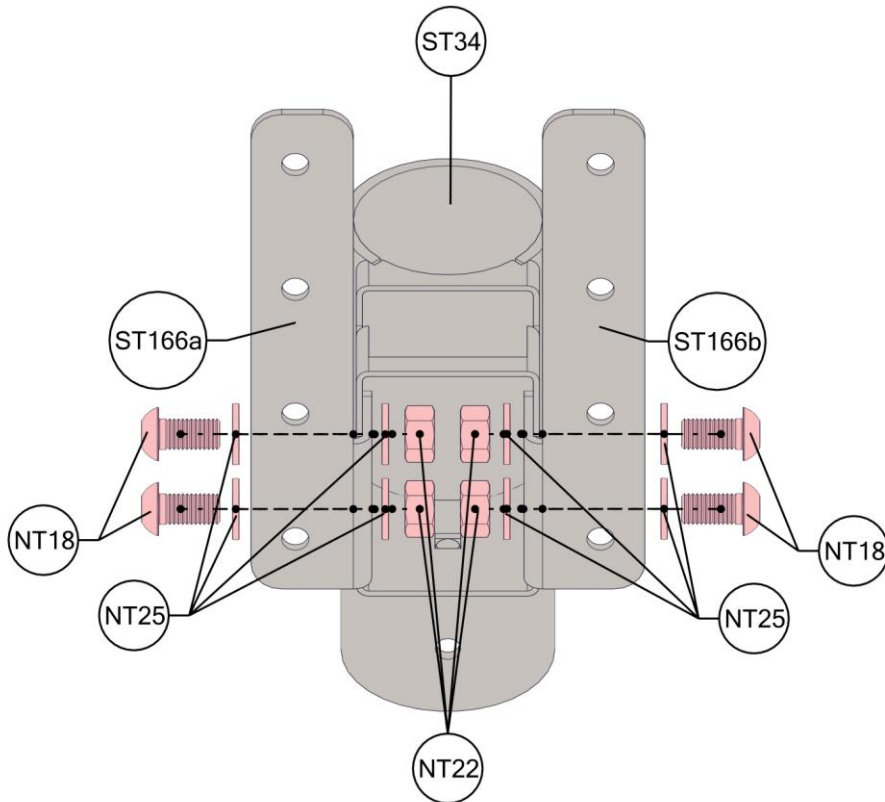
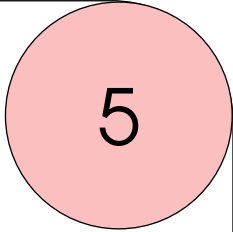

185-234 mm

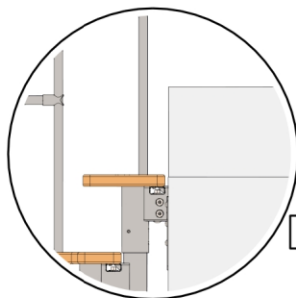

13xS: (185mm ↔ 234mm) + 35mm

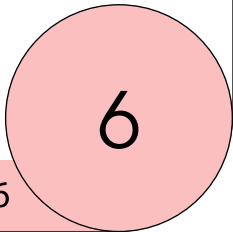
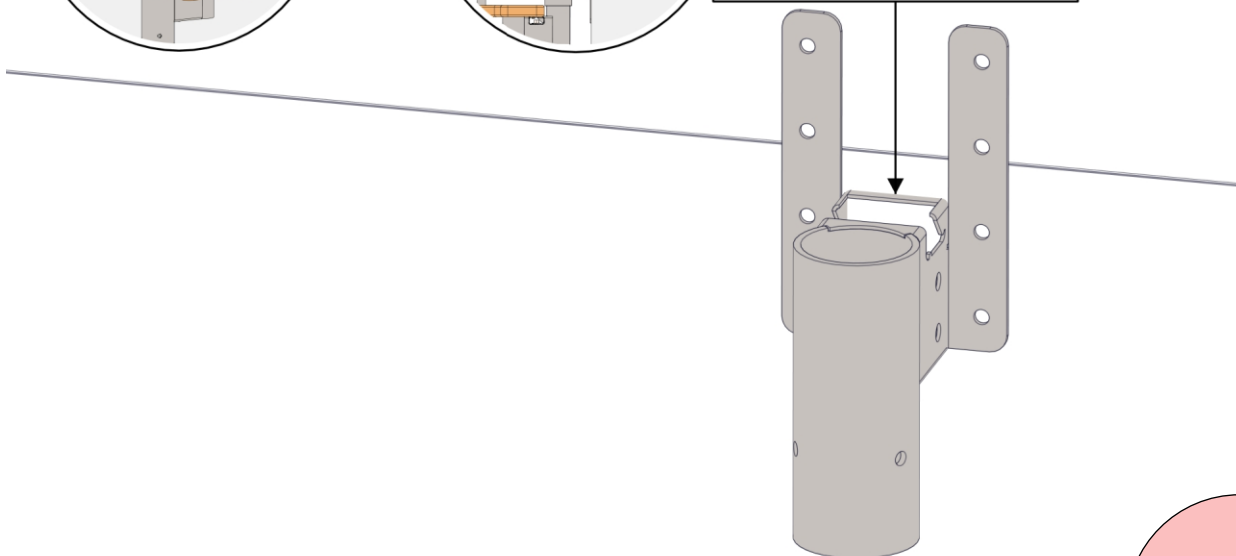

7

Ø12mm

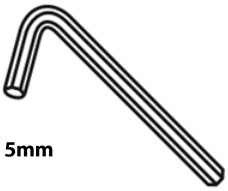
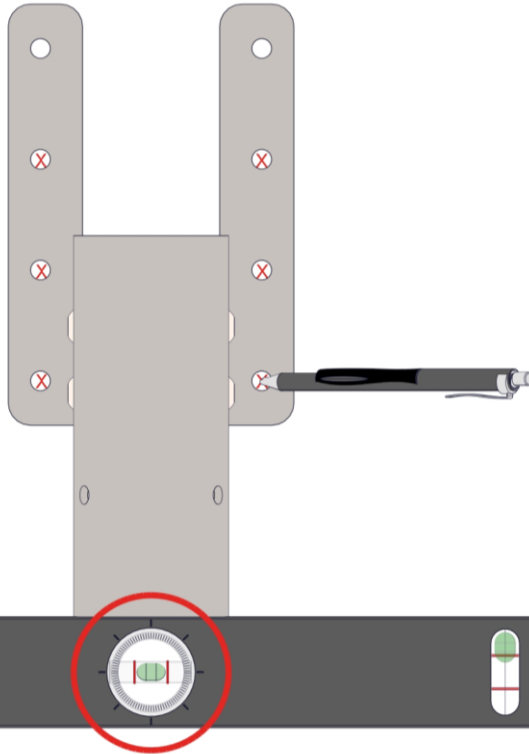
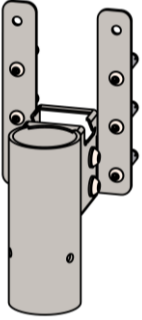
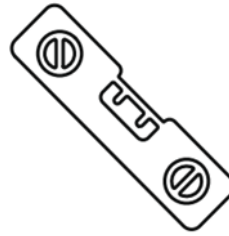
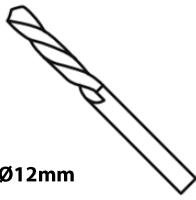

5mm

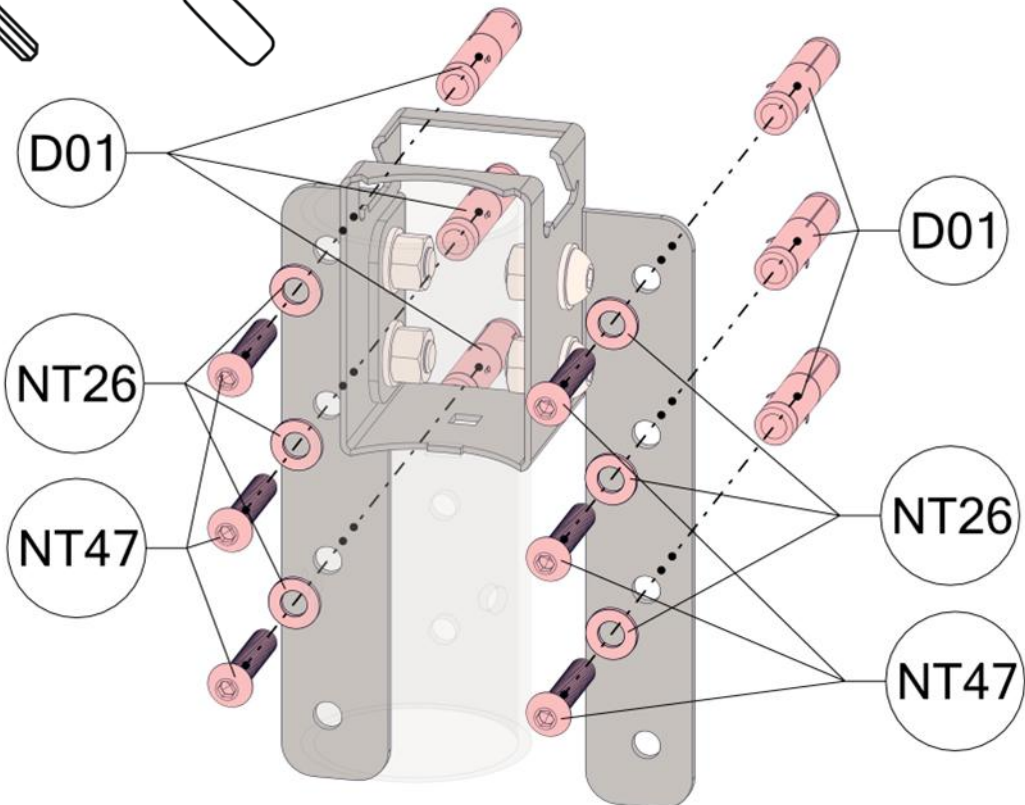
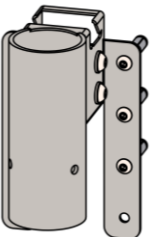
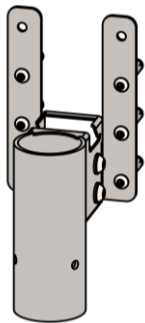

8

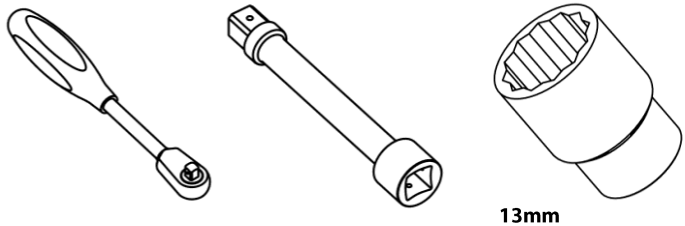
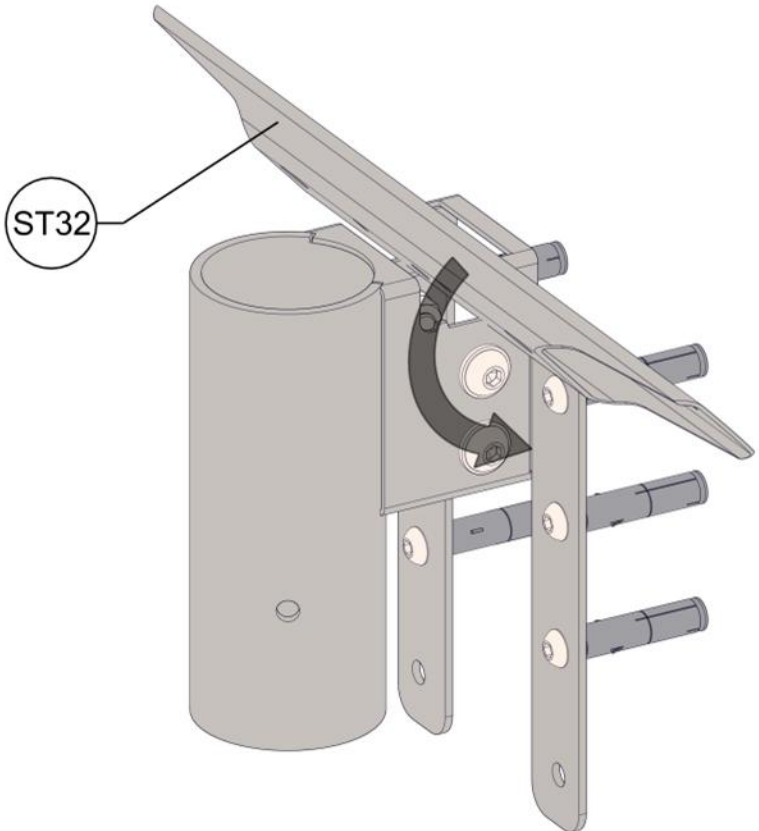

13mm

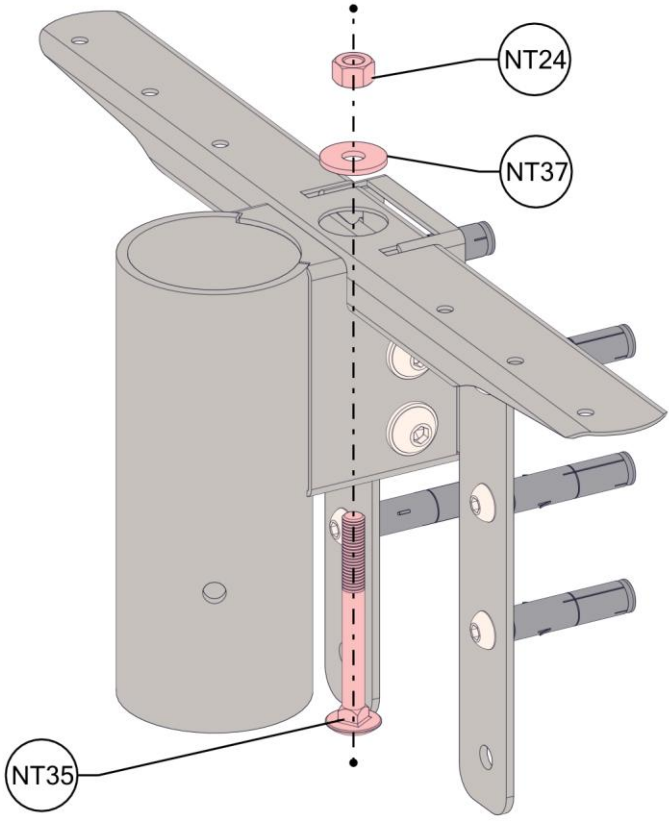

11

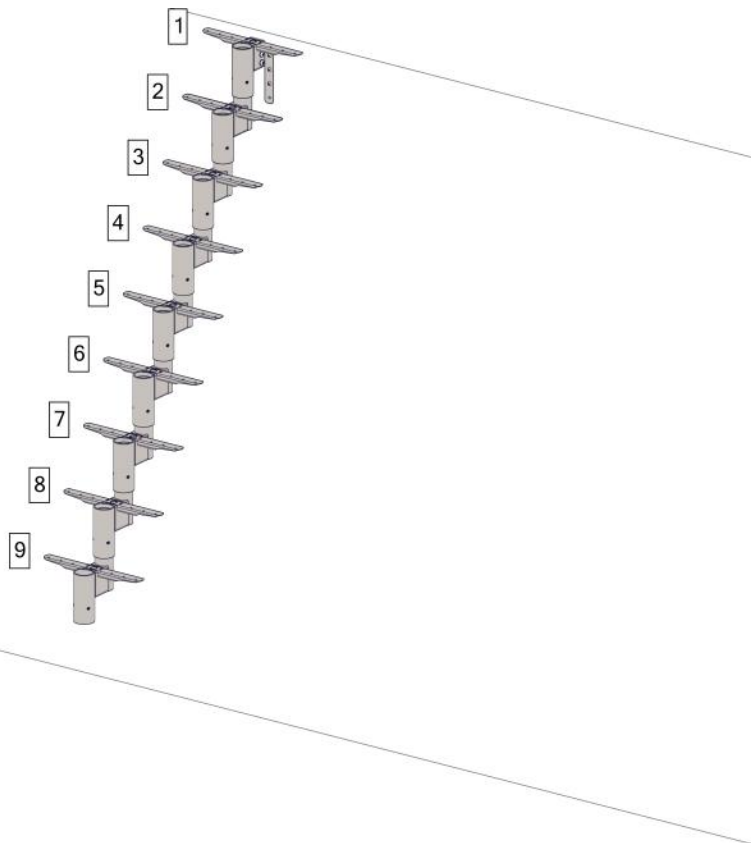
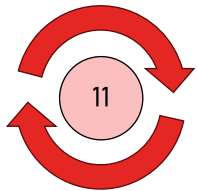
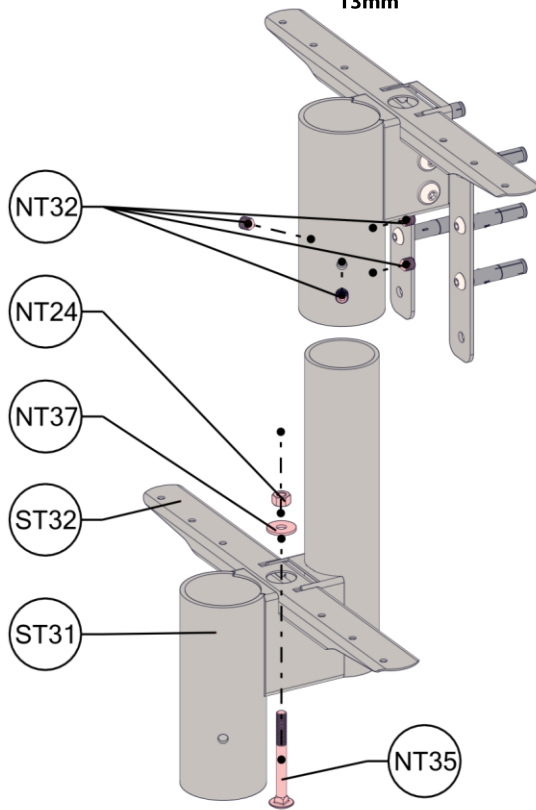
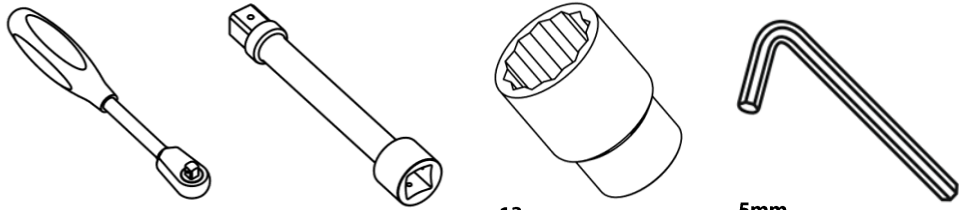

12

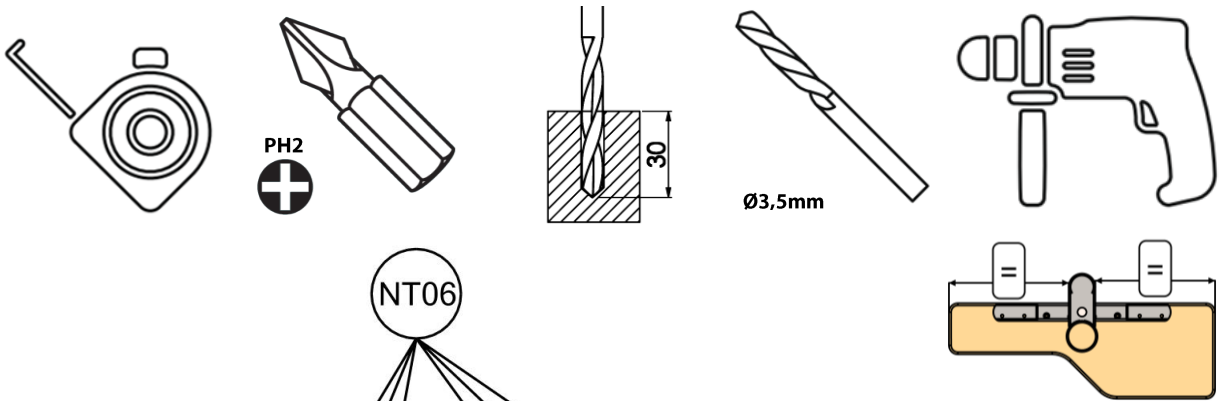
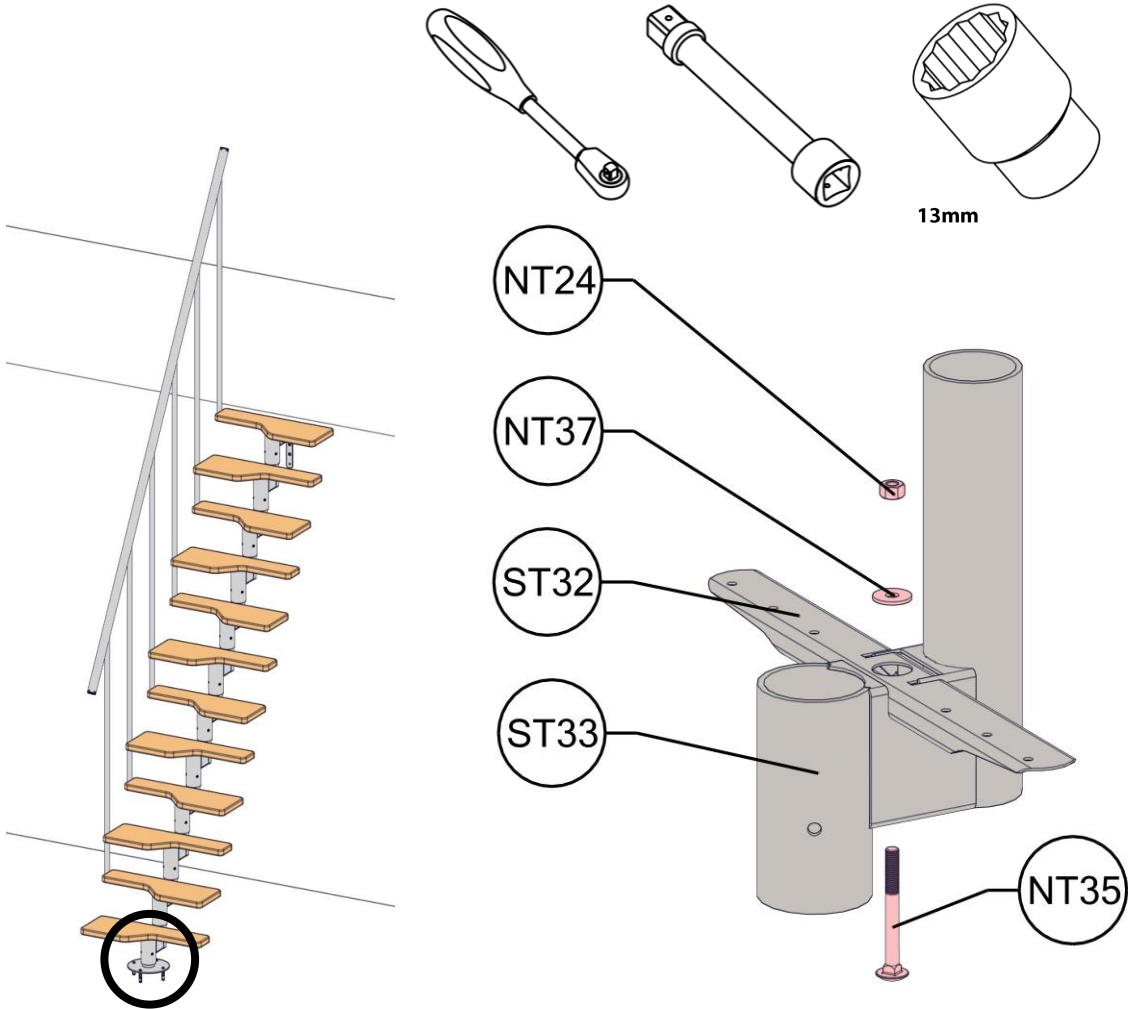

15

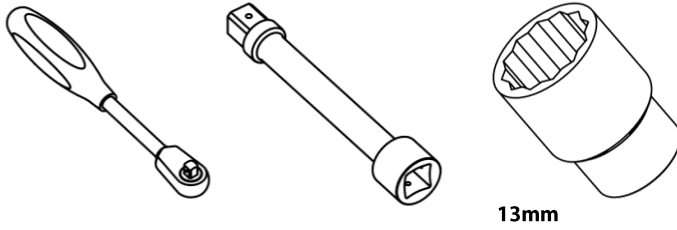

13mm

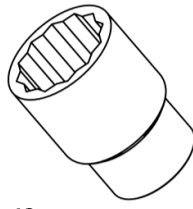
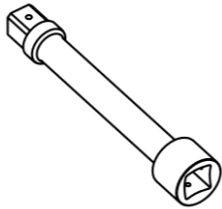
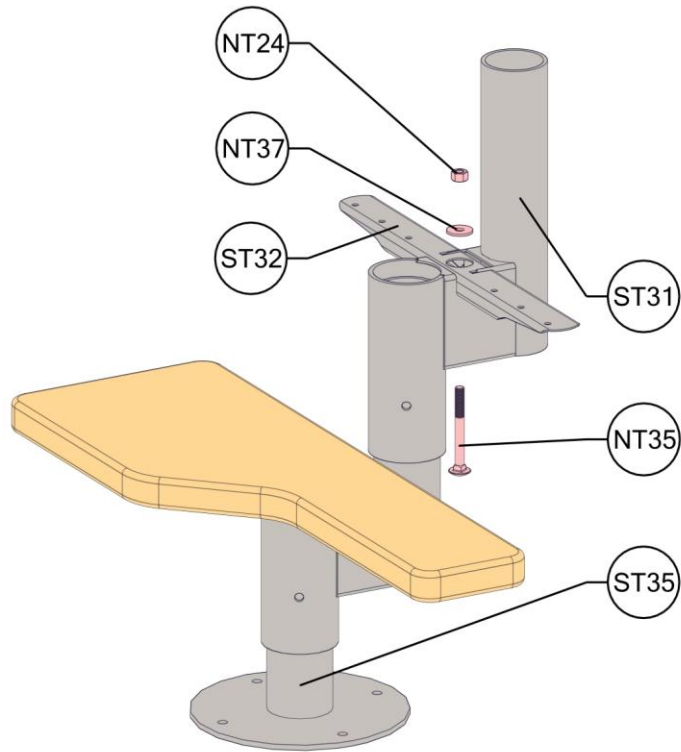

13mm

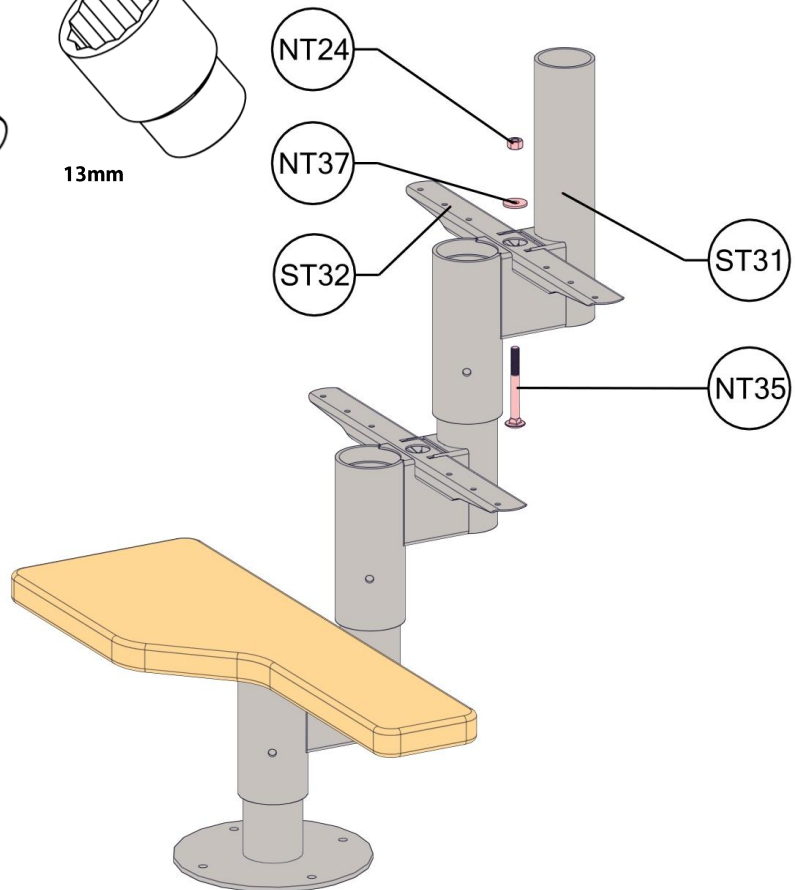

16

17

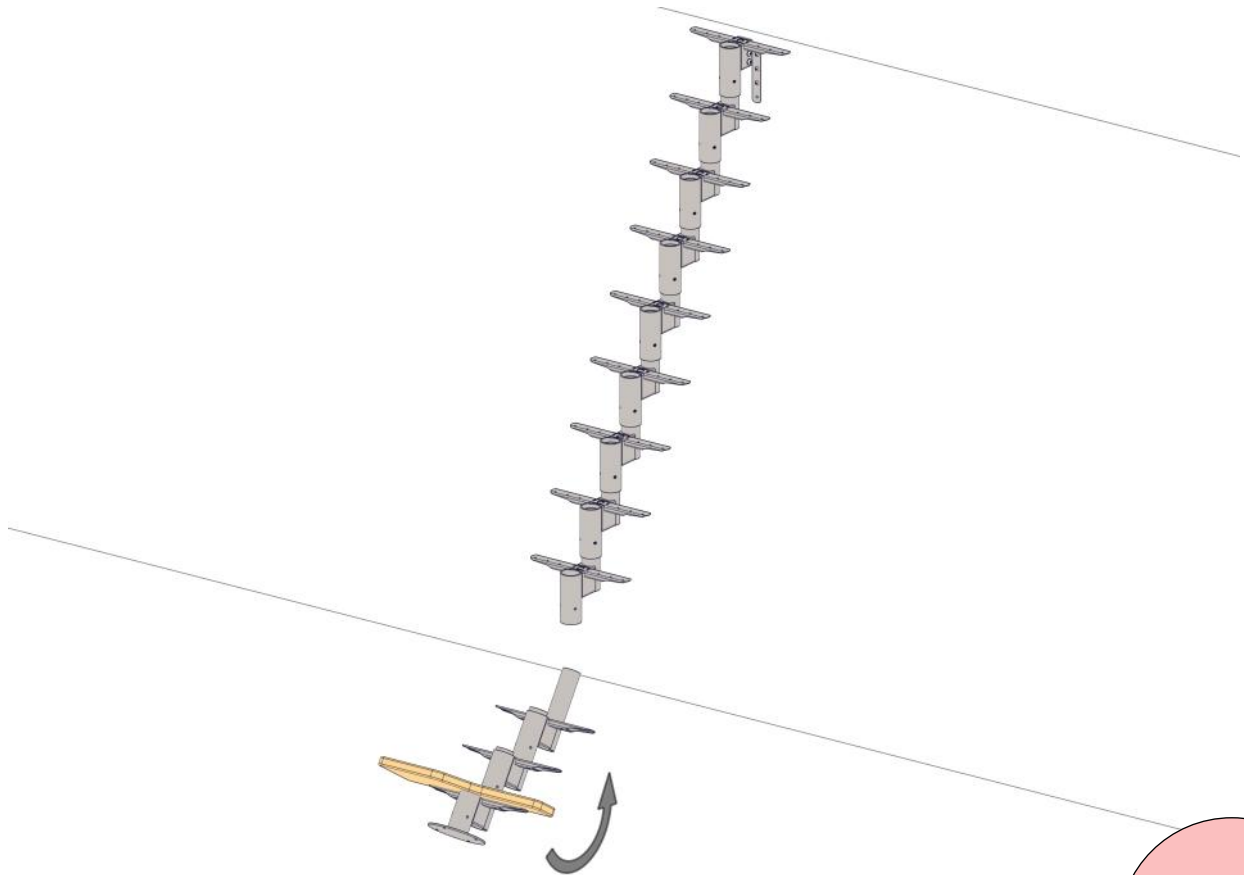
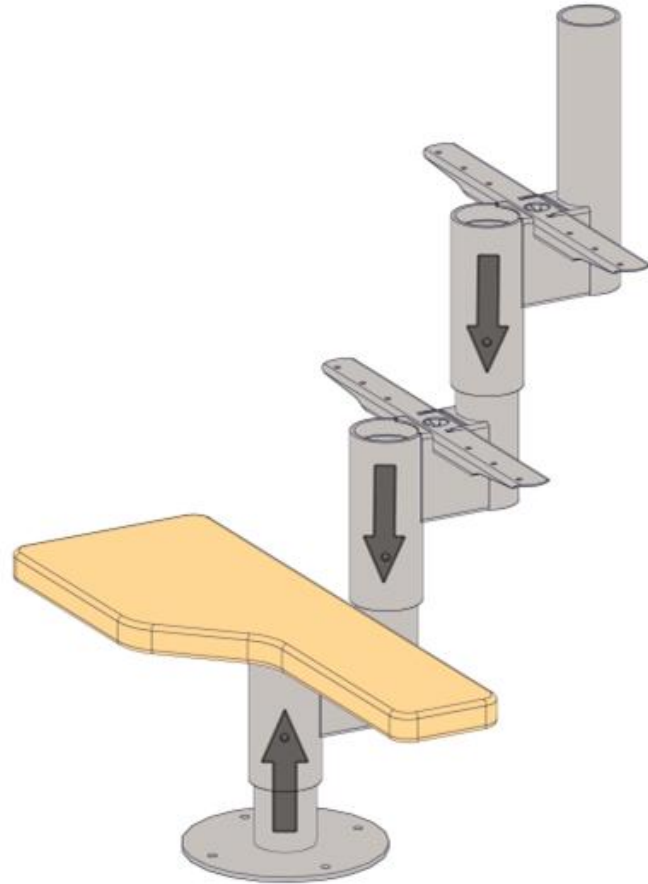

18

19

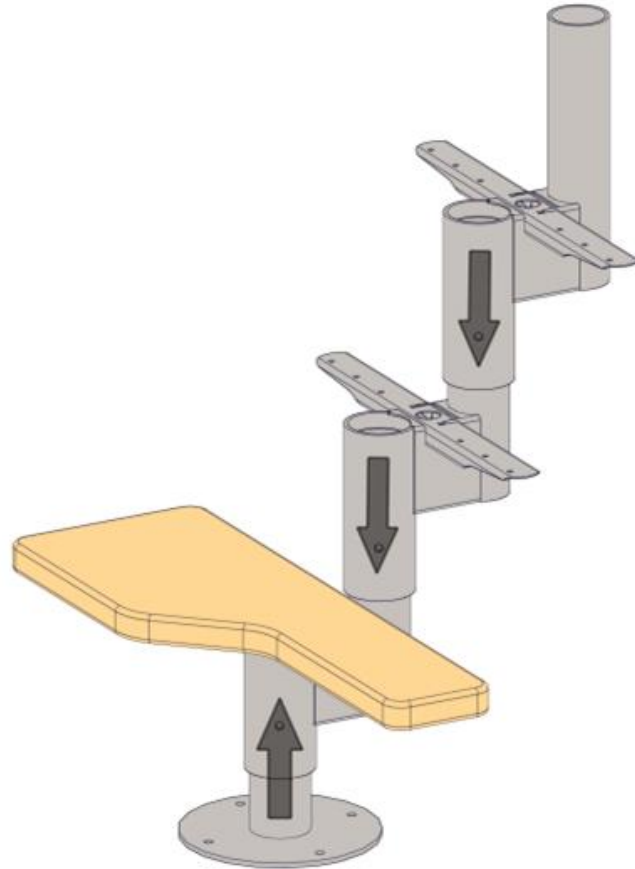

5mm

NT32

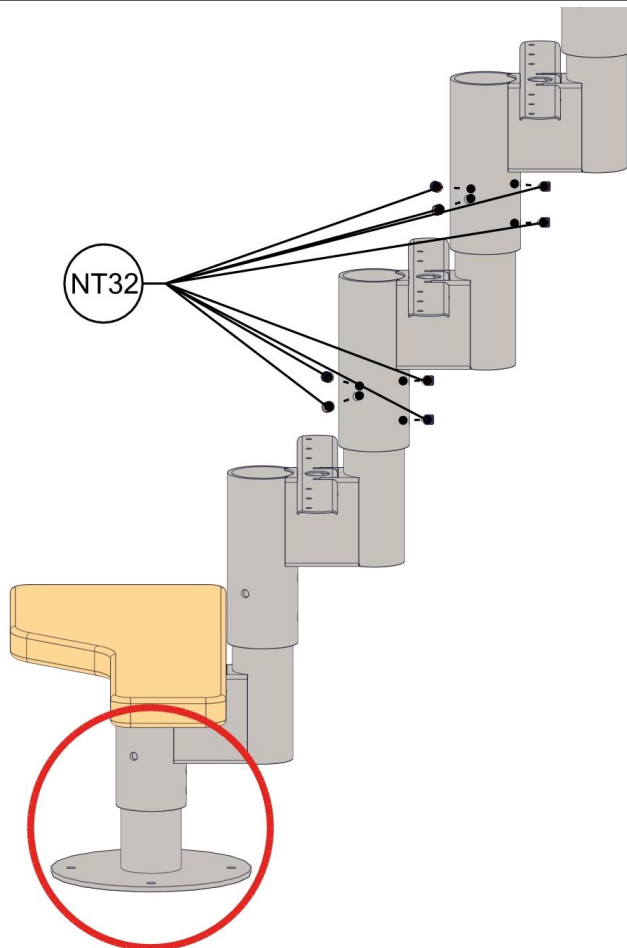

20

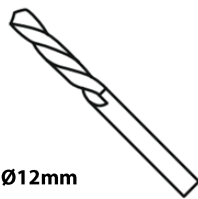

21

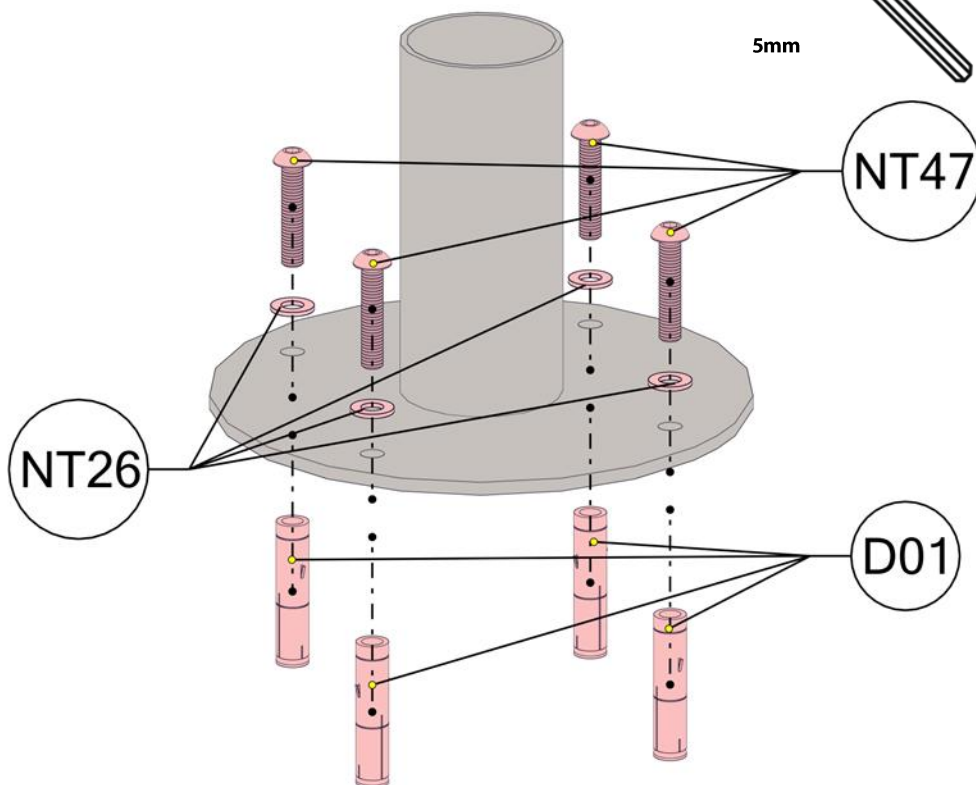
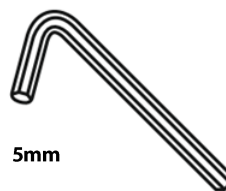
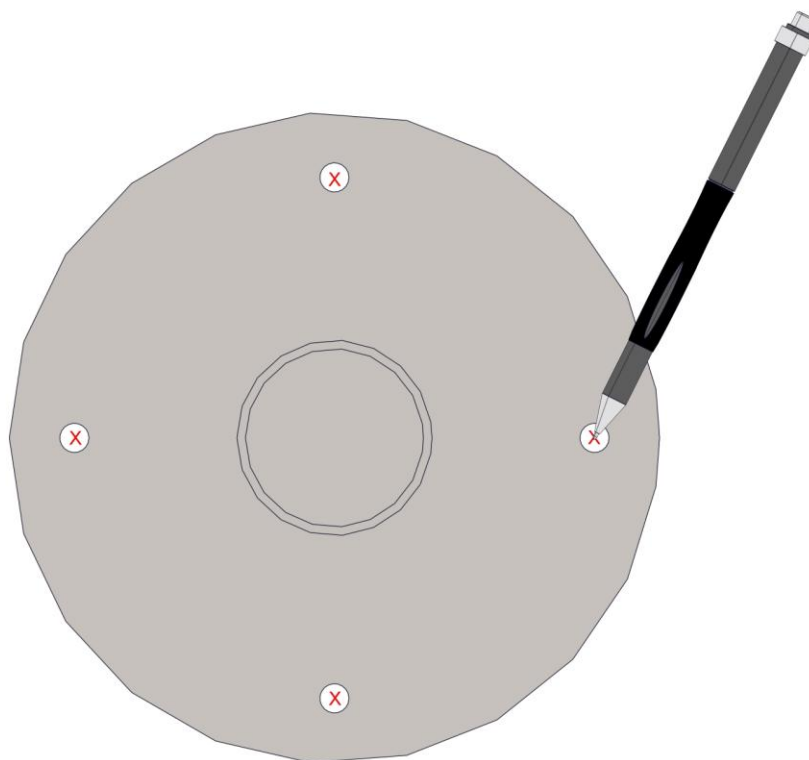

22

23

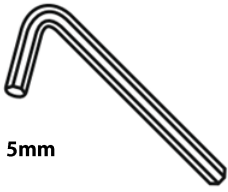

5mm

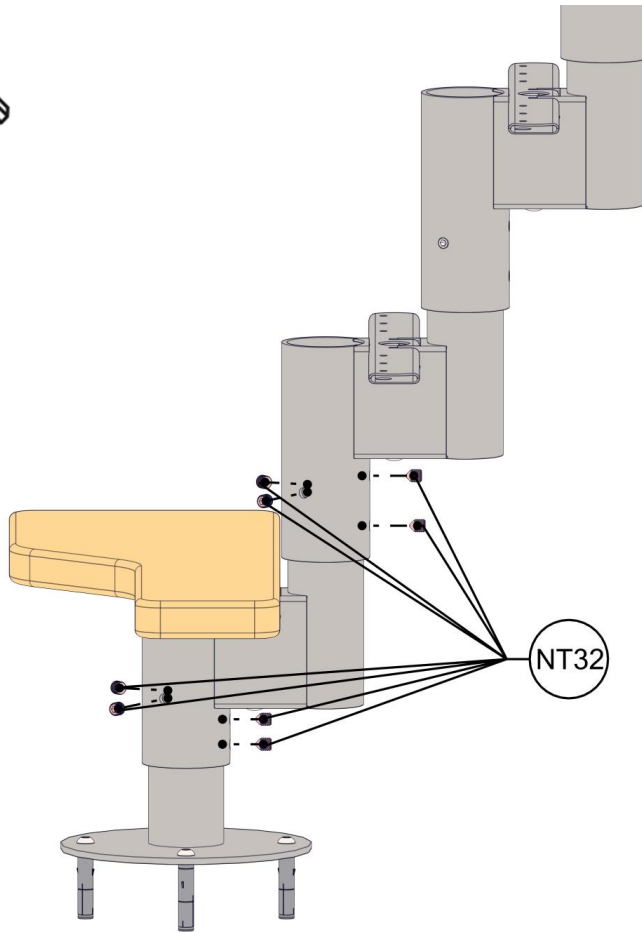

NT32



40mm

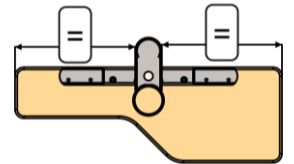

ST22

ST32

HS09

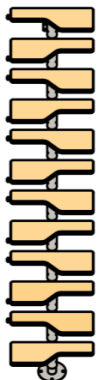

24

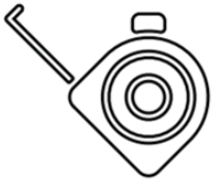

PH2
+

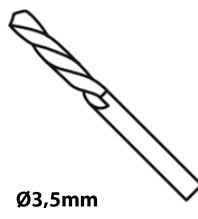
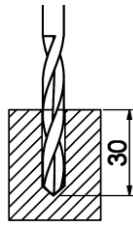

Ø3,5mm



25

NT06

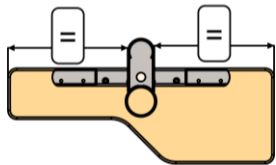
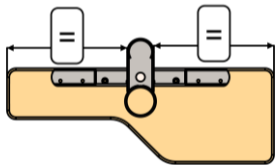
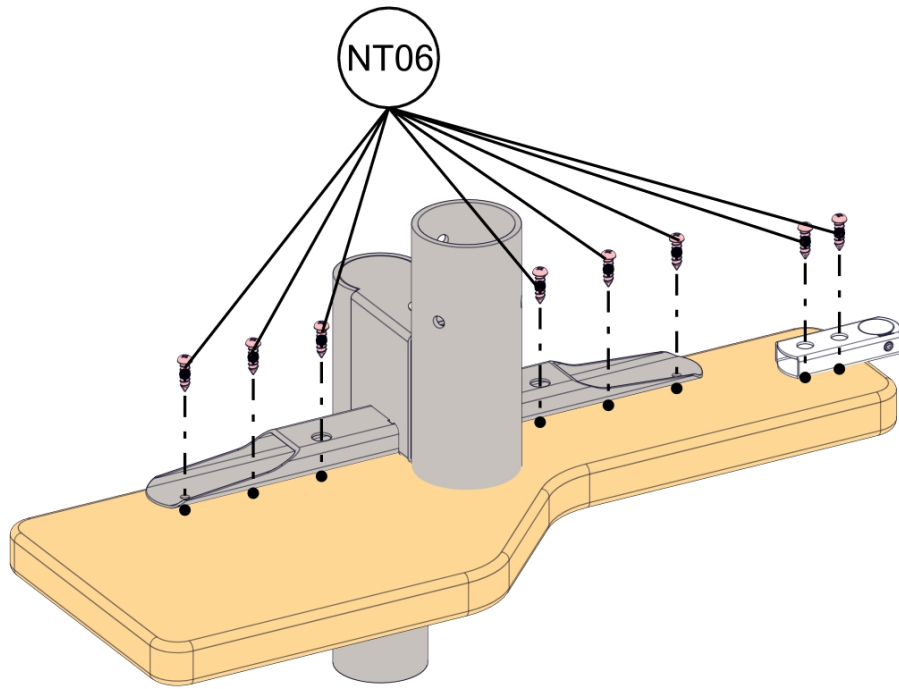

150mm

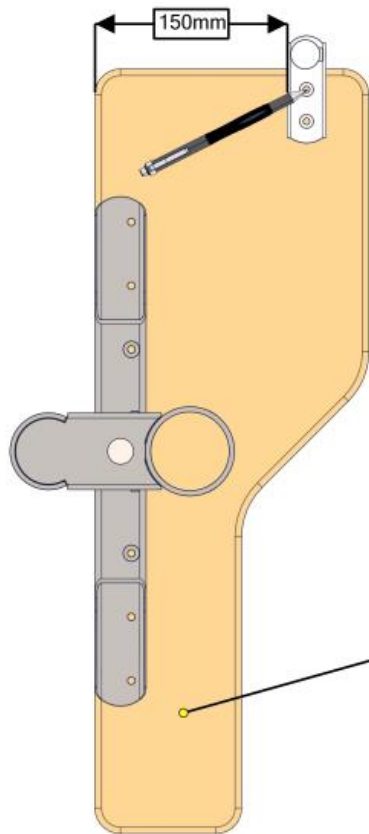

HS09

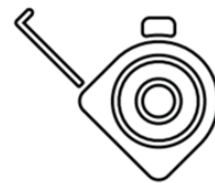

26

27

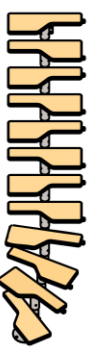
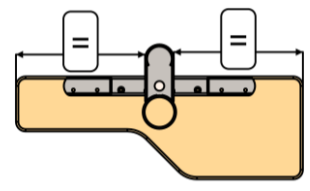
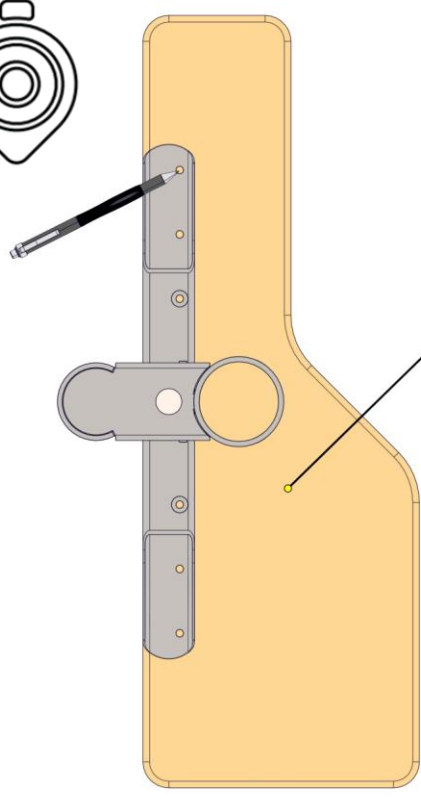
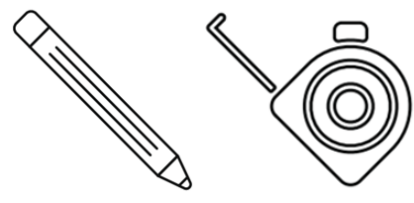
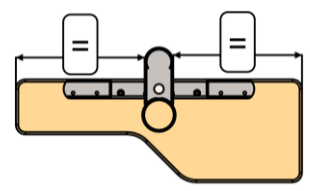
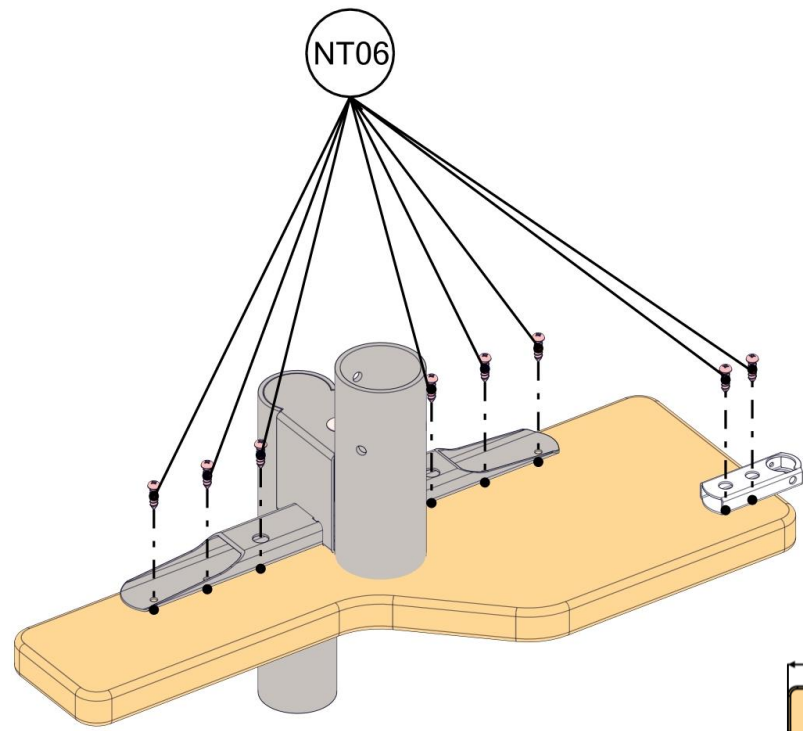
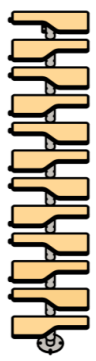
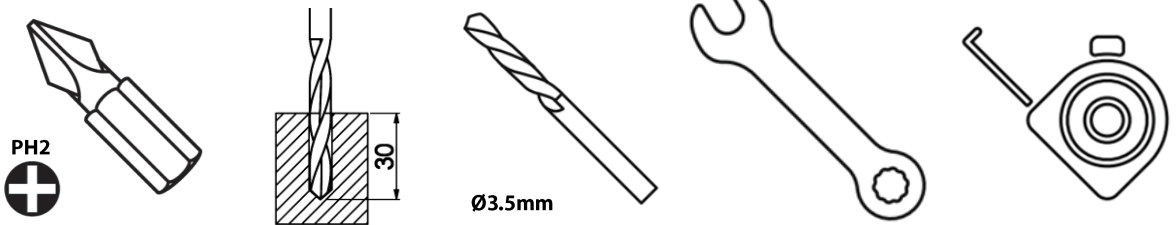

28

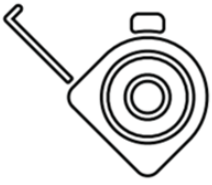

PH2

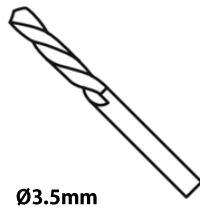
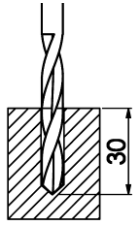

Ø3.5mm



NT06

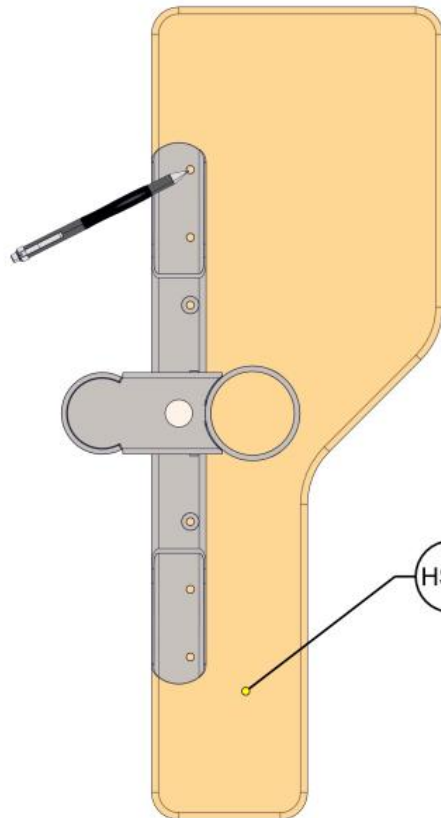
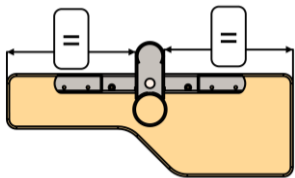
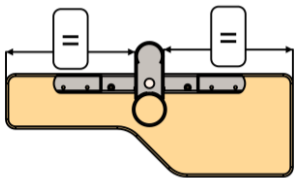
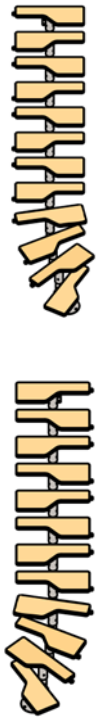
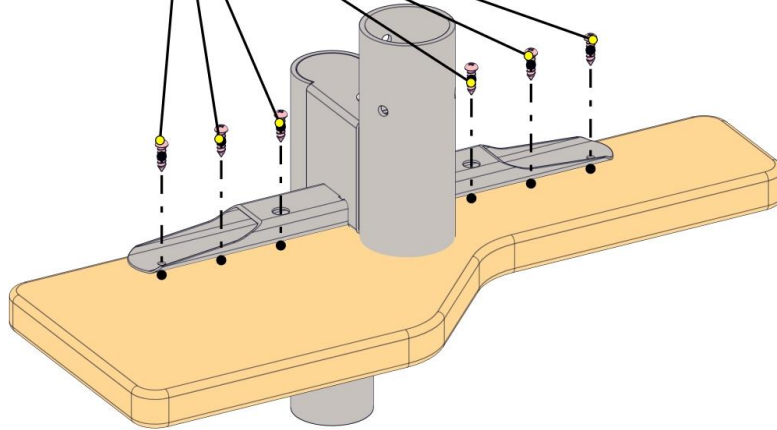

HS09



31

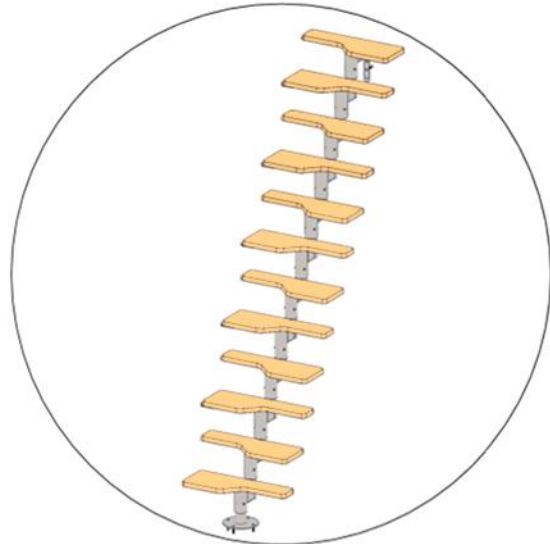
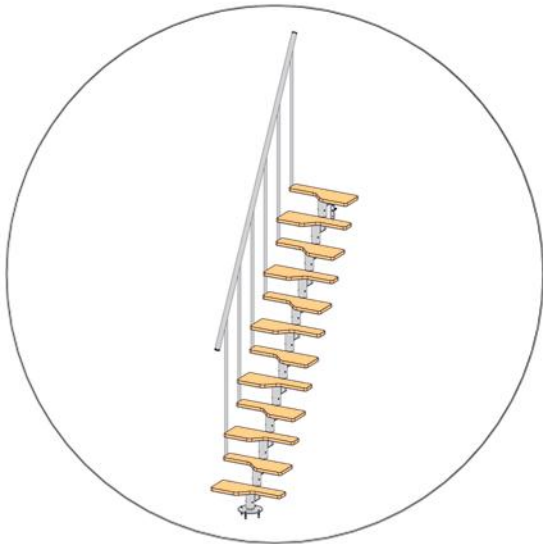
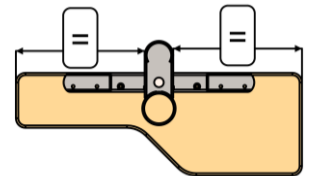
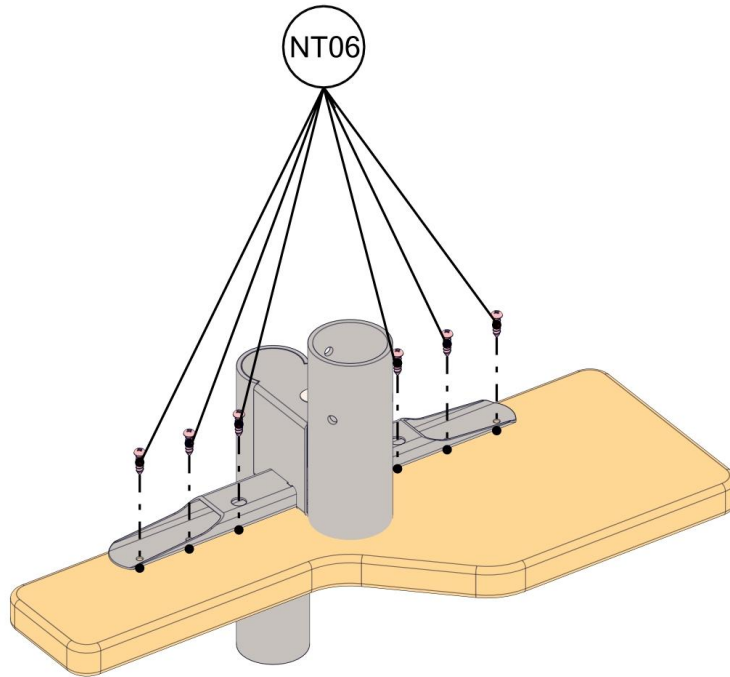
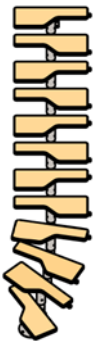
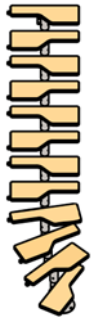
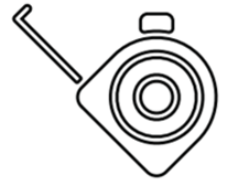
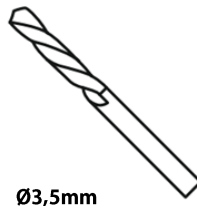
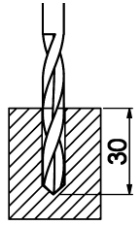
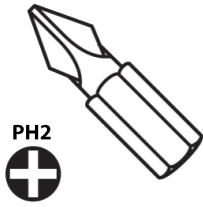

32



33

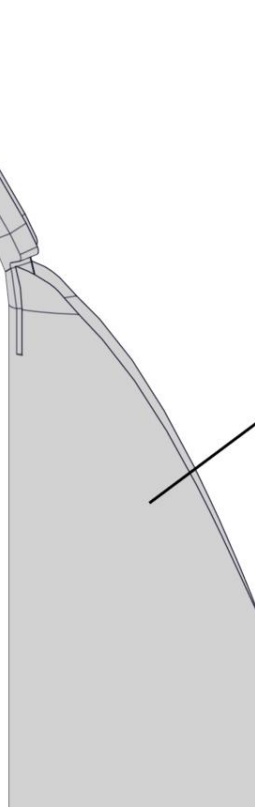

GS11

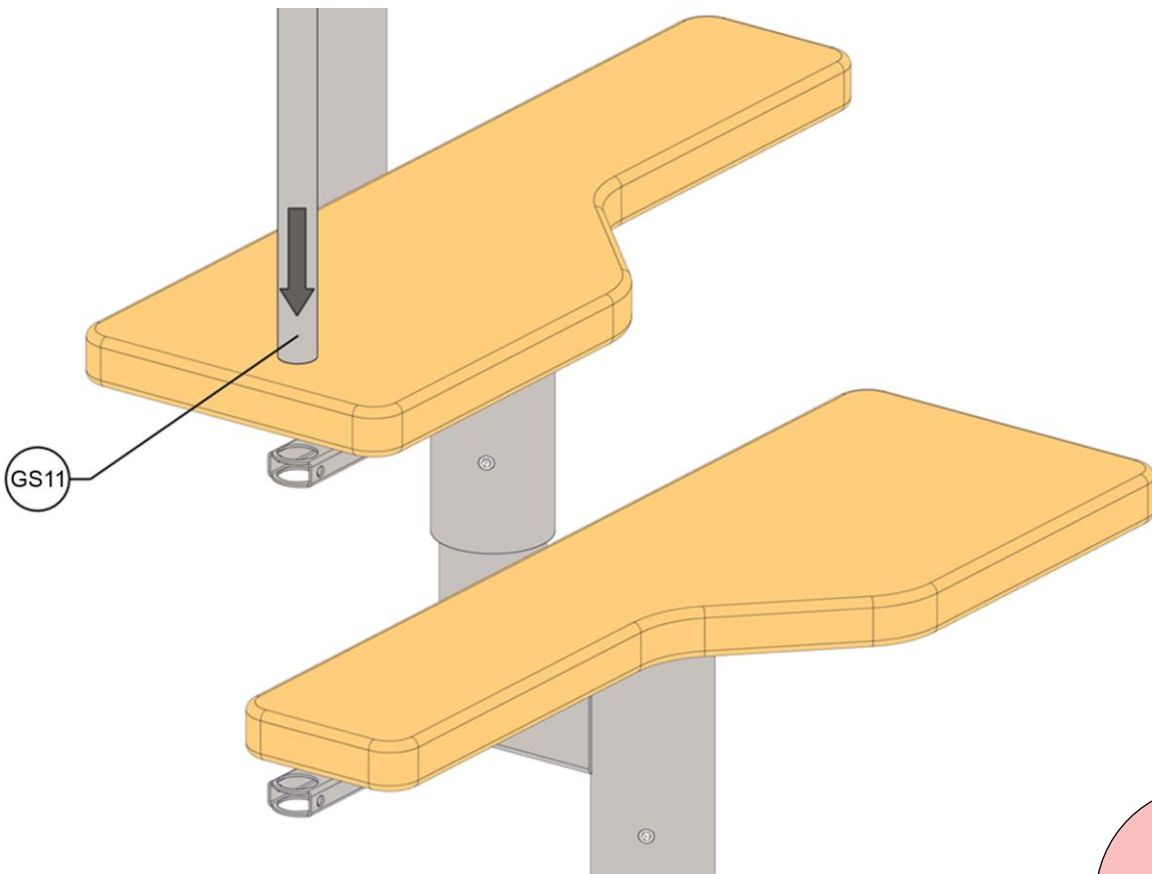

GS11

34

35

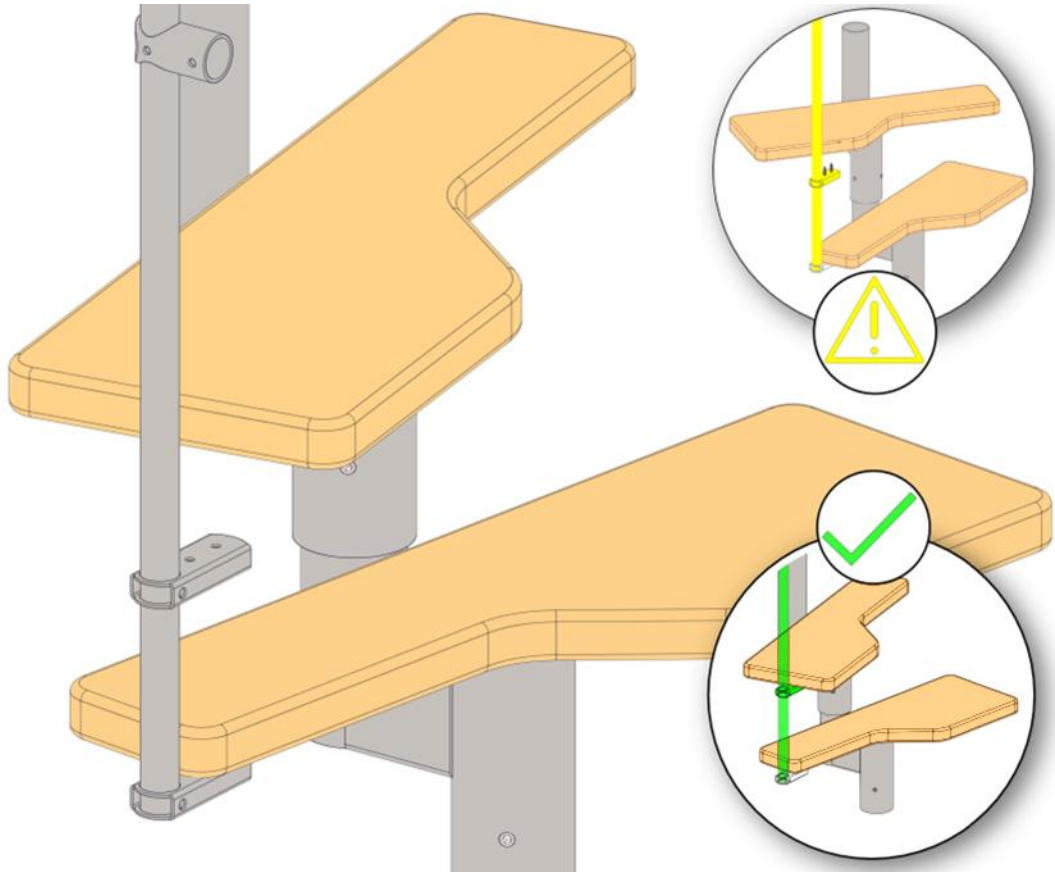
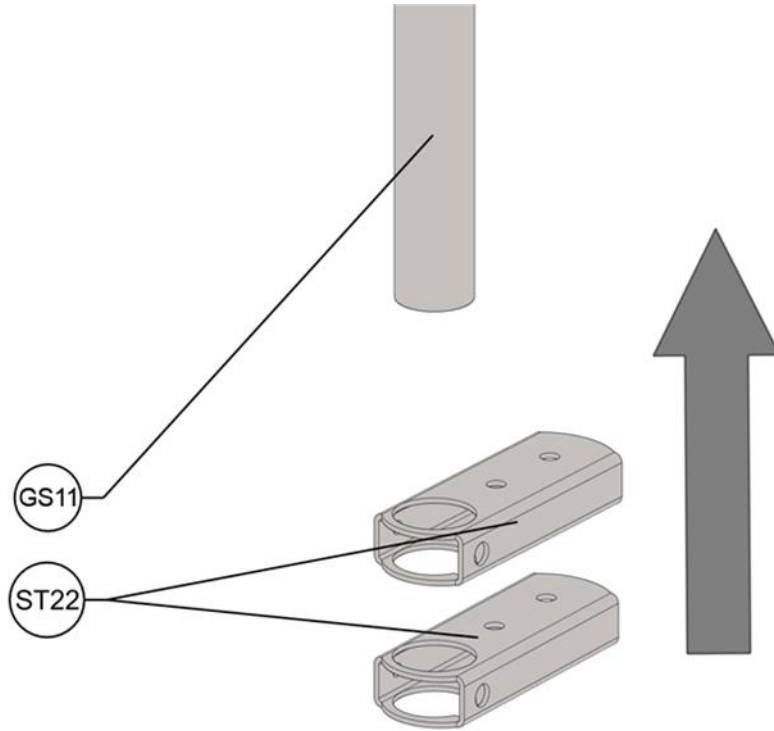
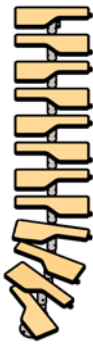
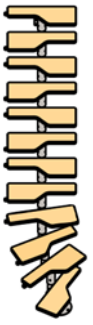

36

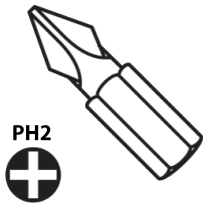

PH2

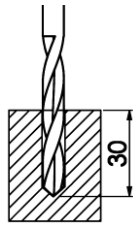

30

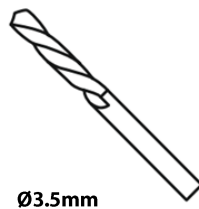

Ø3.5mm



37

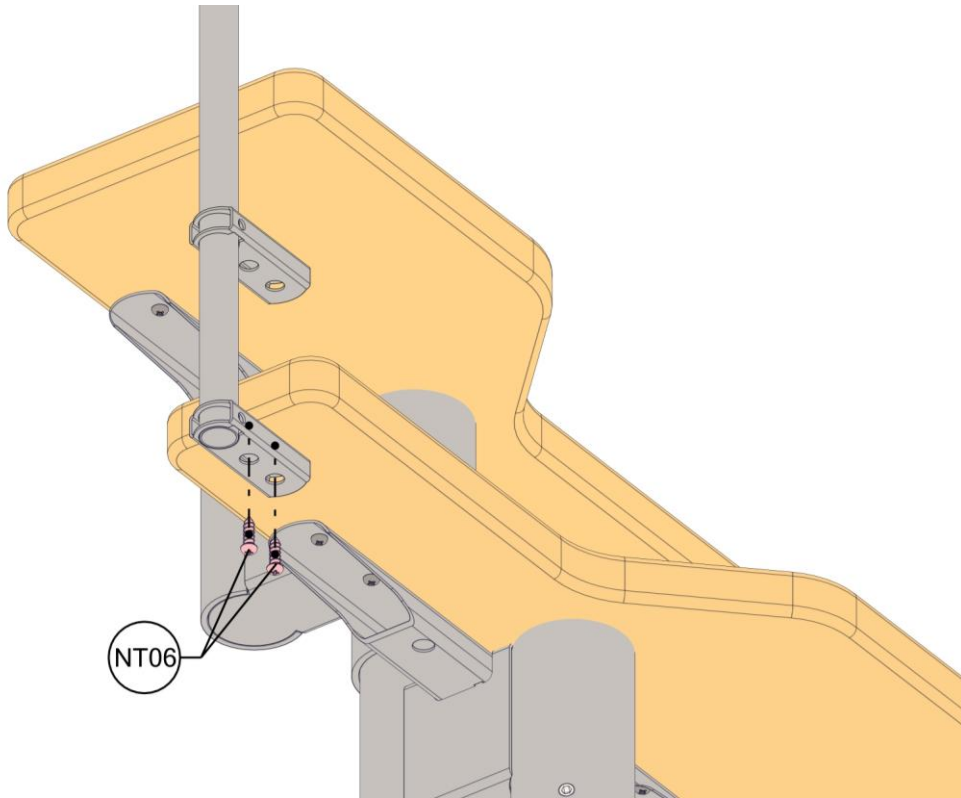

NT06

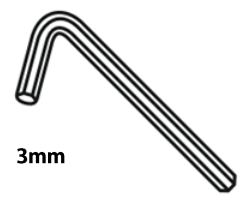
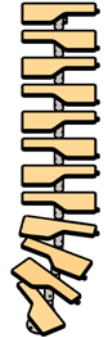
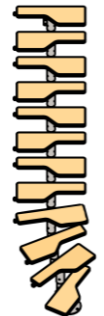

3mm

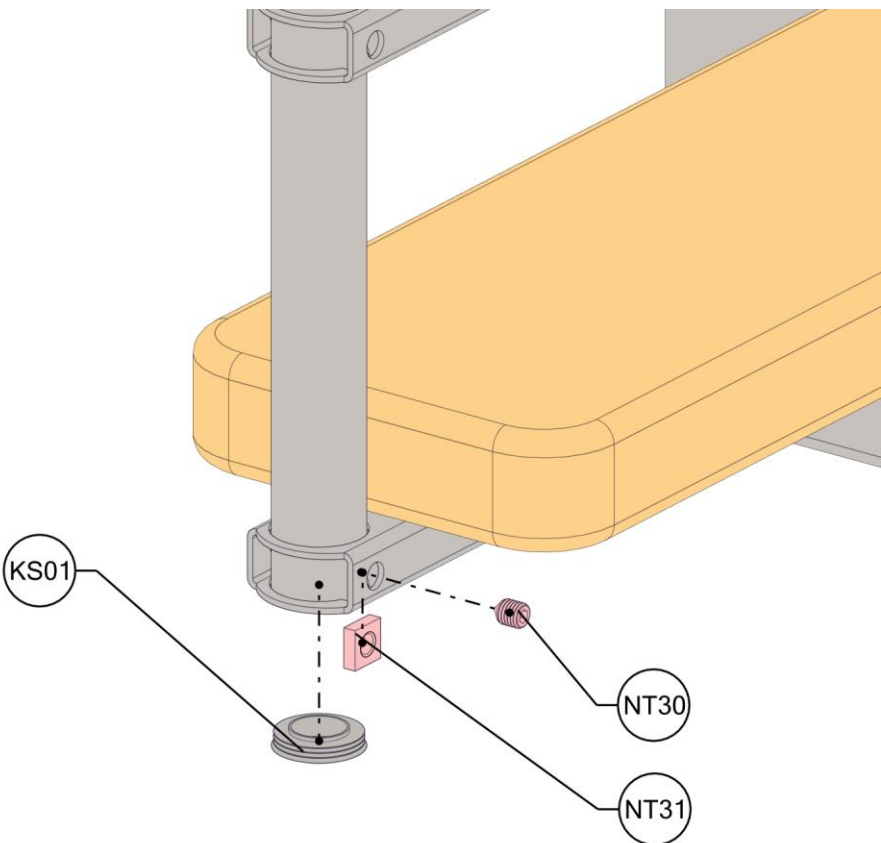

KS01

NT30

NT31

38

39

PH2

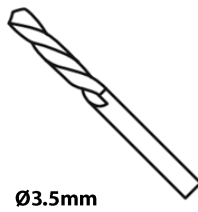
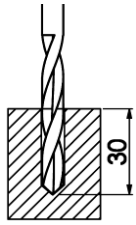
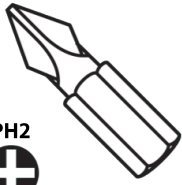

Ø3.5mm

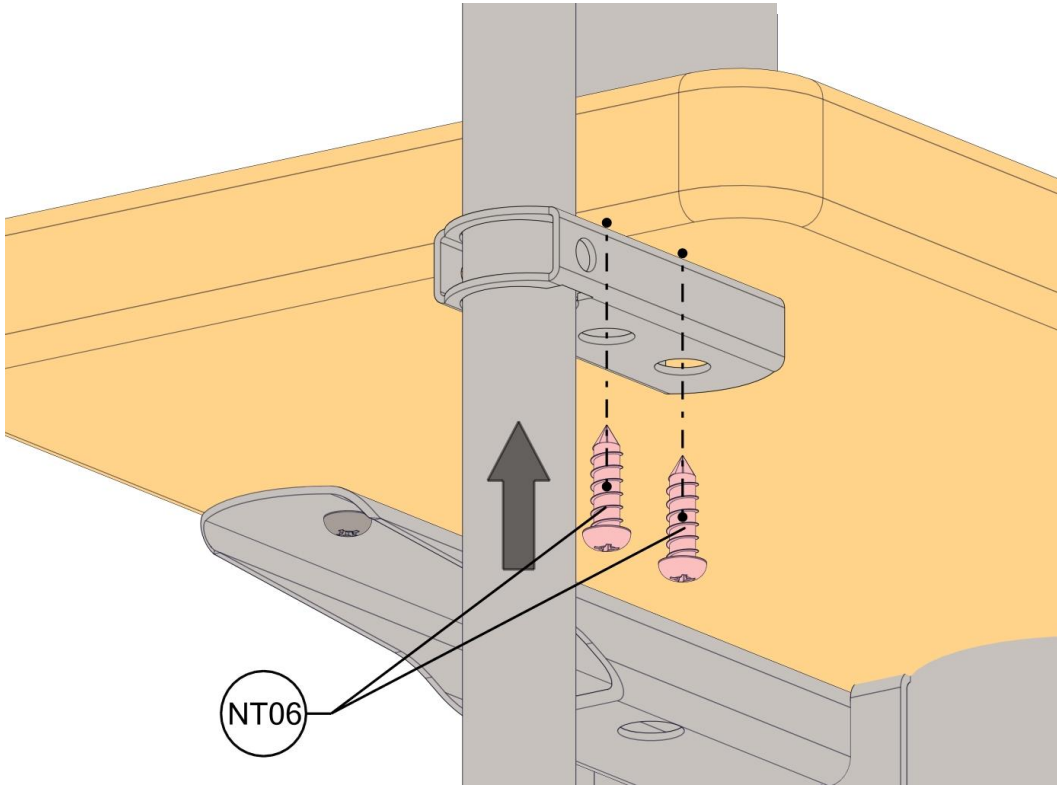

NT06

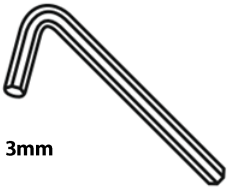

3mm

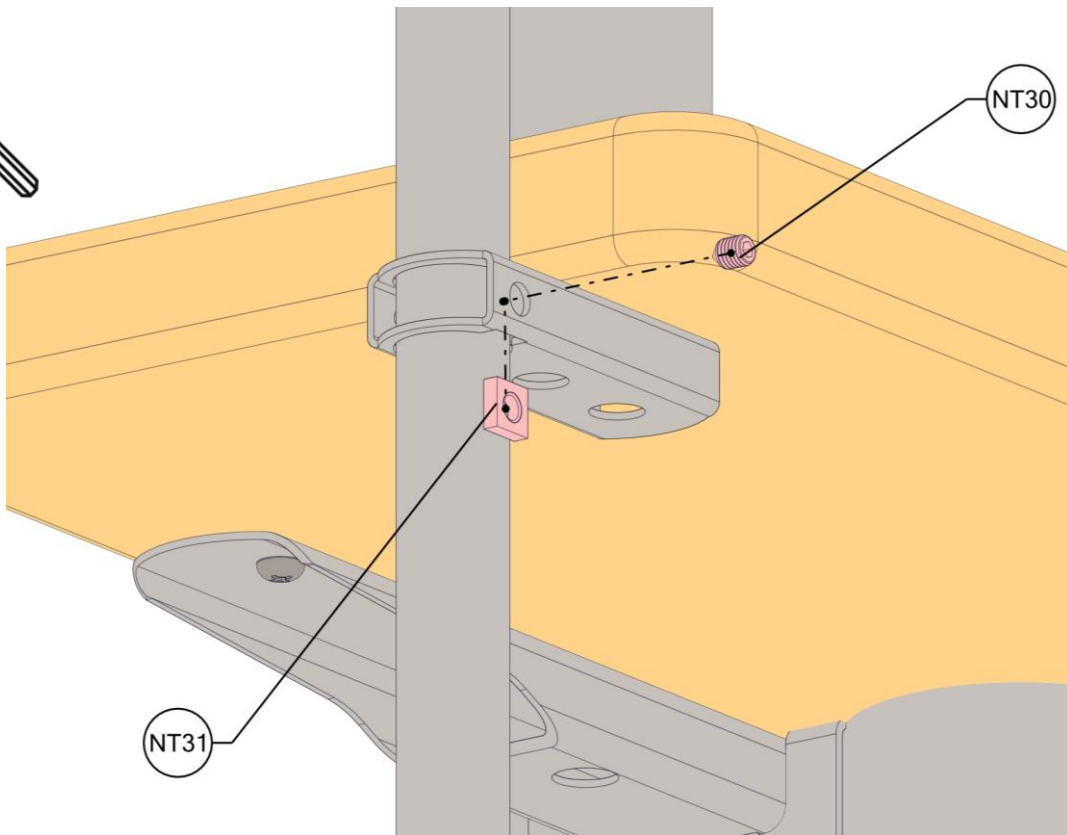

NT30

NT31

40

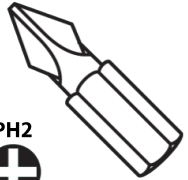
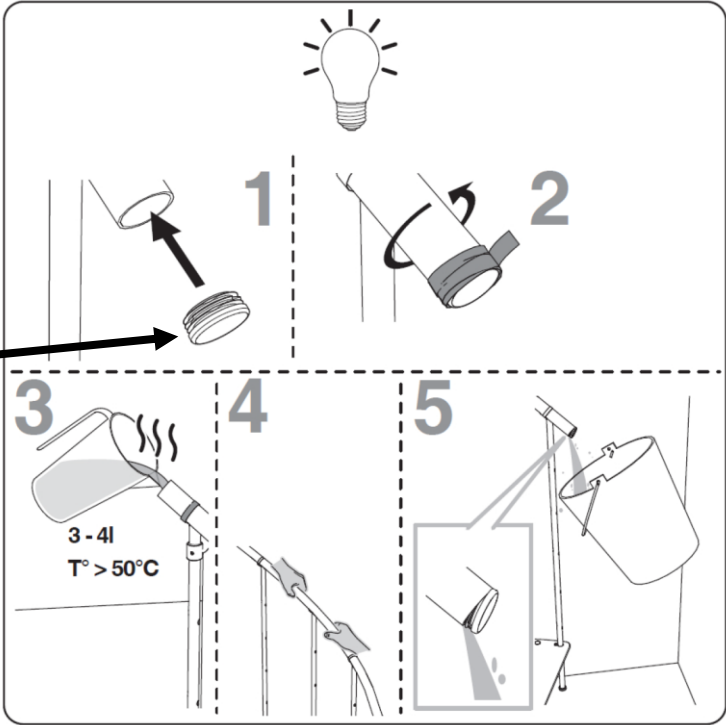
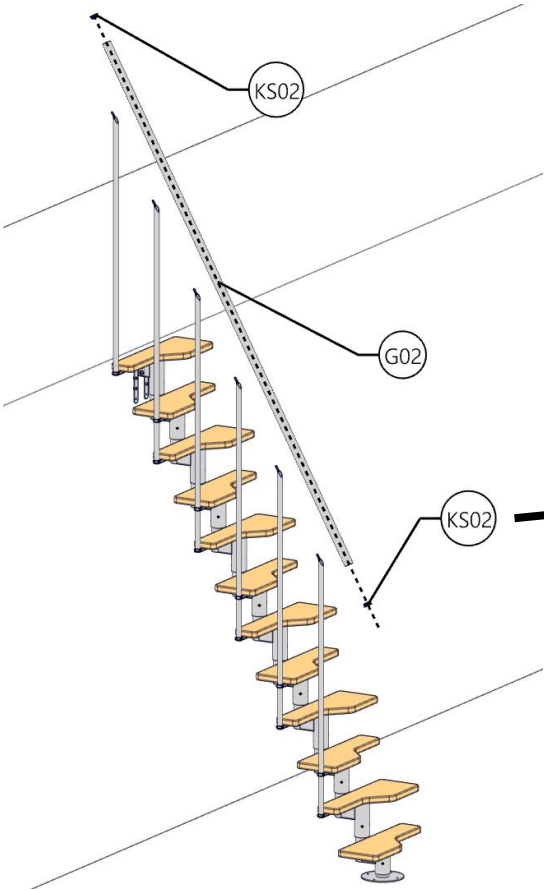

PH2

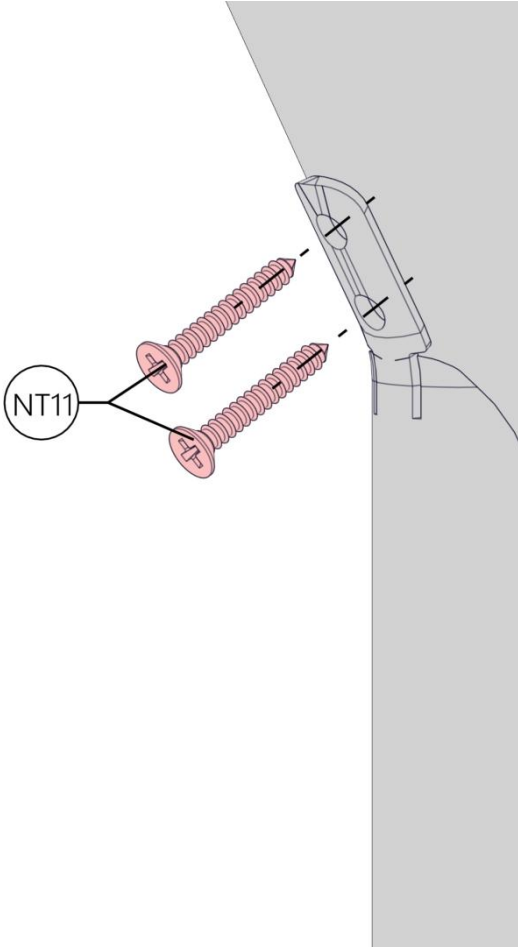
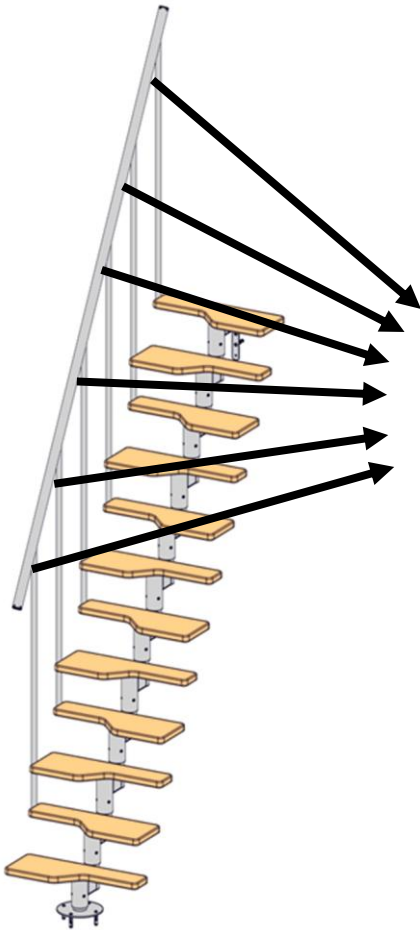

NT11