

# TERRA 120 MIX

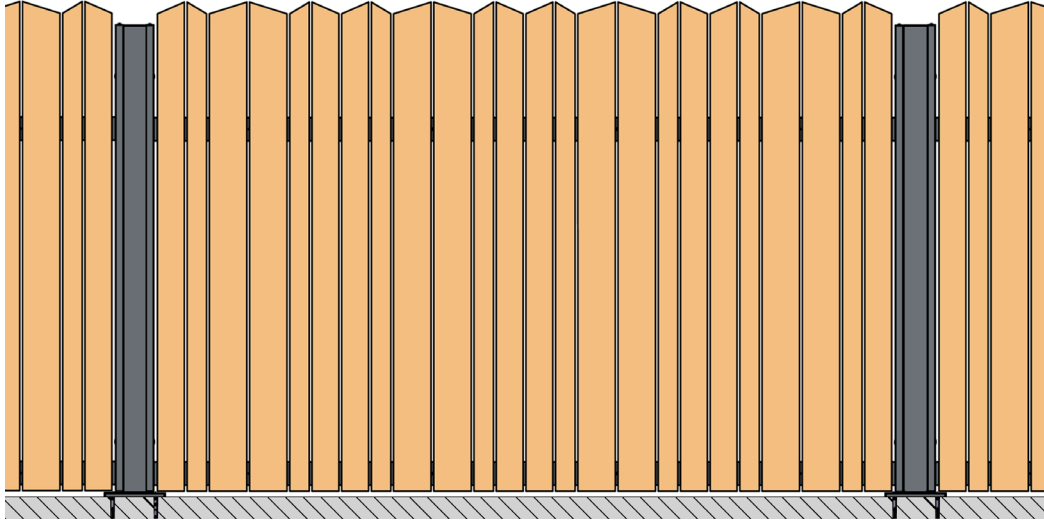

A



B

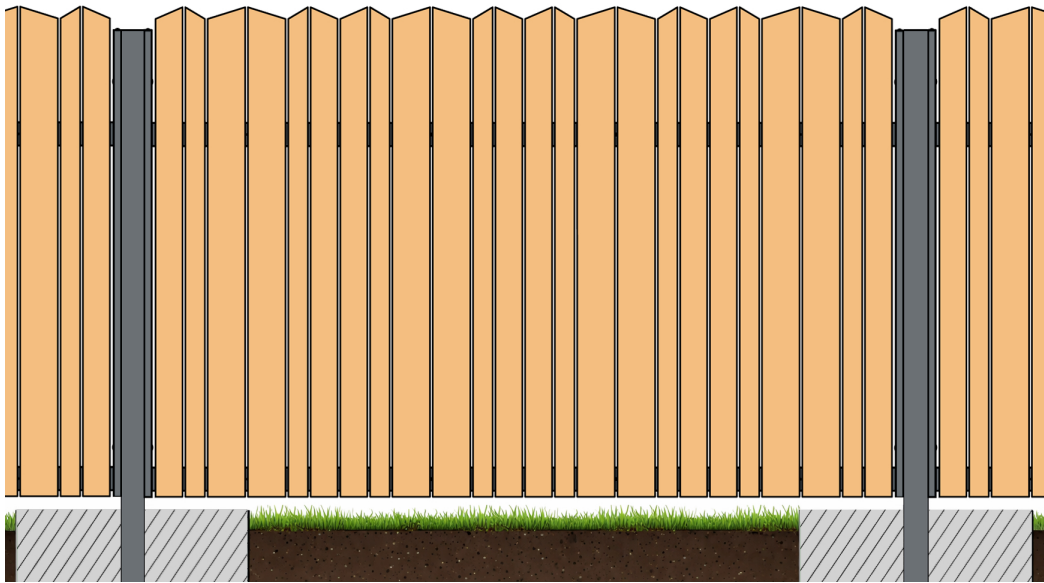

C

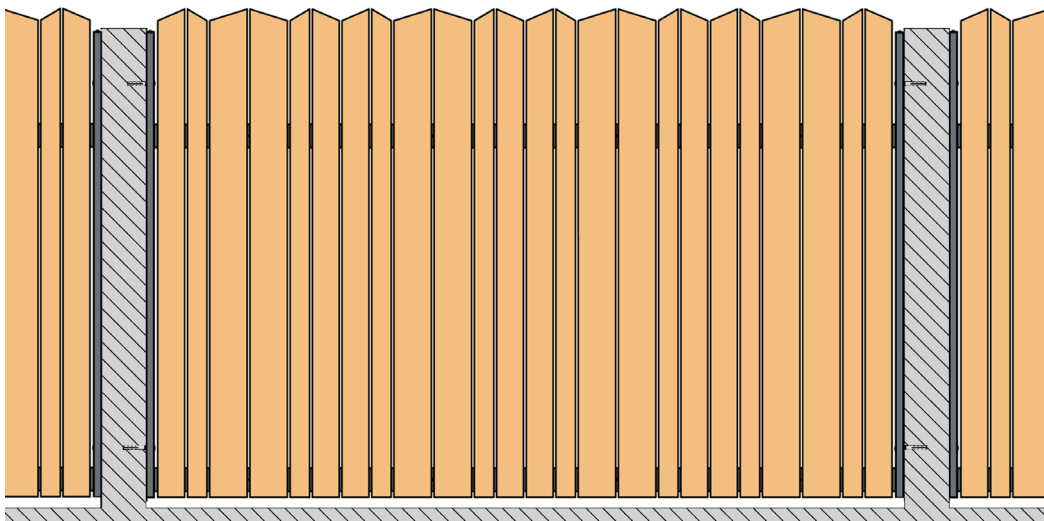

# TERRA 120 MIX

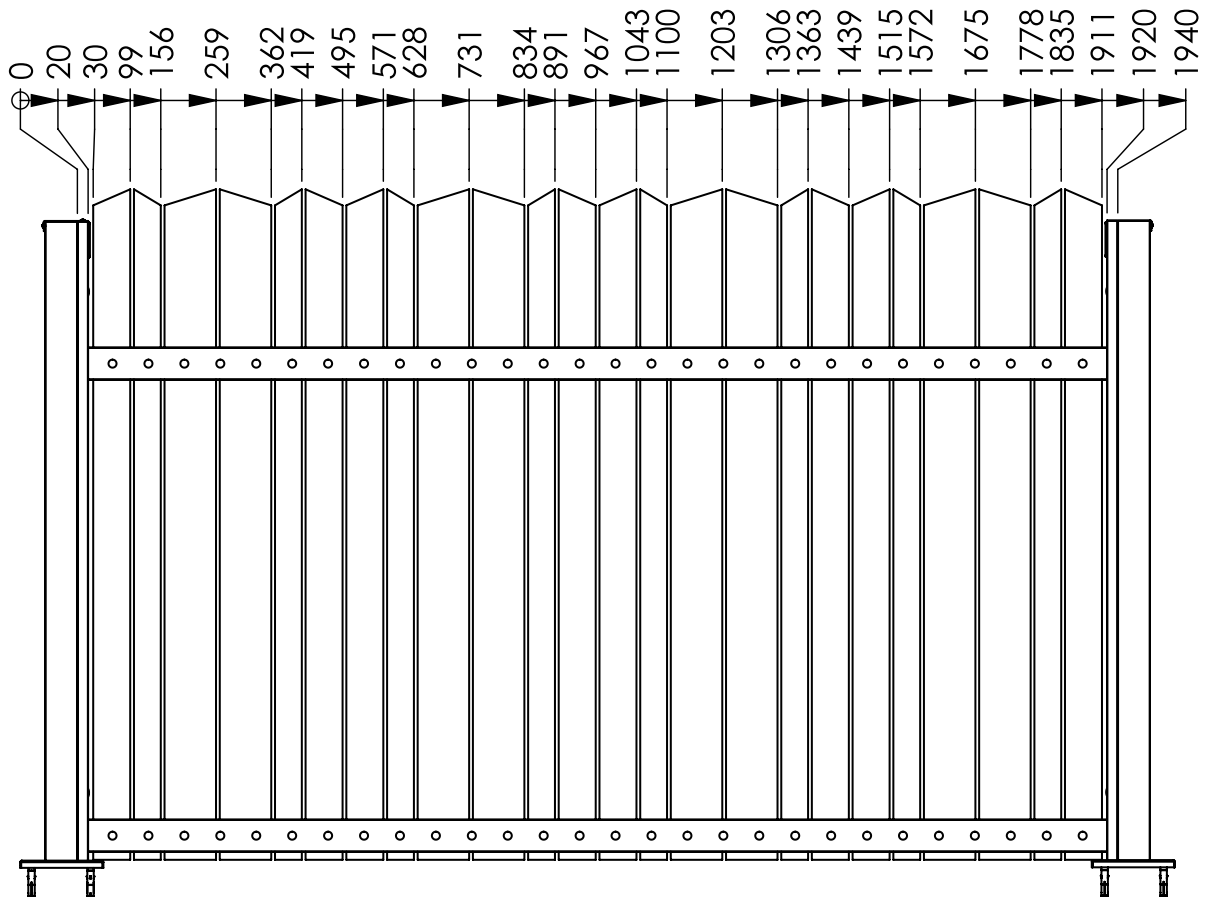
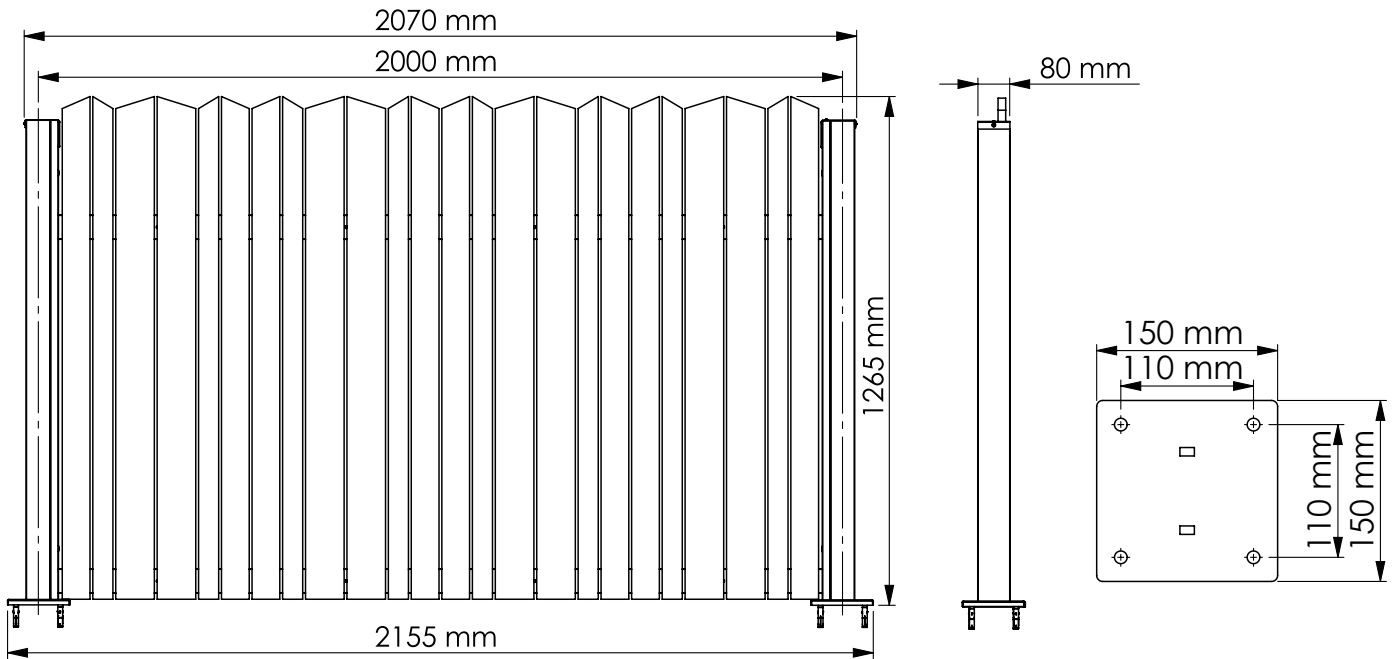

# TERRA 120 MIX



8x

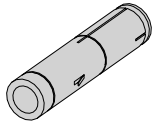

D01 M8x55 mm

60x

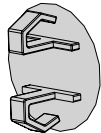

KS09 Ø13mm

2x

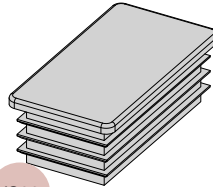

KS22 35x65 mm

8x

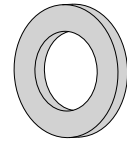

NT26 M8 DIN125A

12x

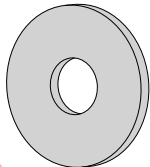

NT39 M8 DIN9021

8x

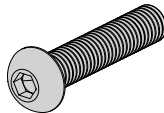

NT47 M8x60 mm ISO7380-1

6x

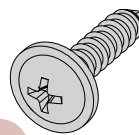

NT77 Ø3,5x16 mm

4x

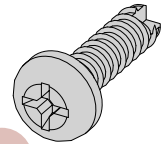

NT79 Ø5,5x22 mm

56x

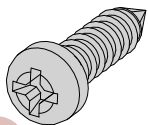

NT85 4x16 mm

2x

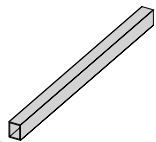

ZT01 80x60x1200 mm

2x

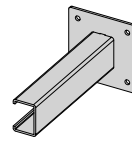

ZT02

2x

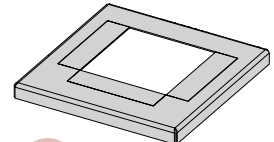

ZT03

2x

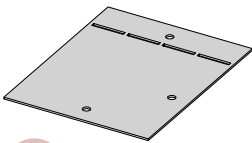

ZT04

2x

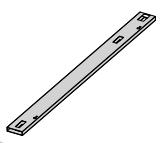

ZT06 80x20x1200 mm

2x

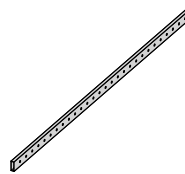

ZT16 60x20x1940 mm

8x

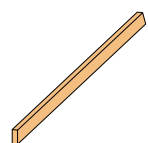

ZT17 50x19x1250 mm

8x

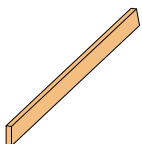

ZT18 69x19x1250 mm

8x

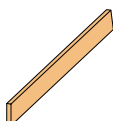

ZT19 96x19x1250 mm

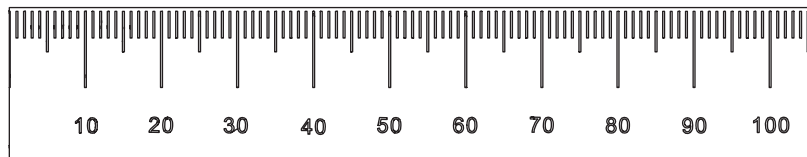
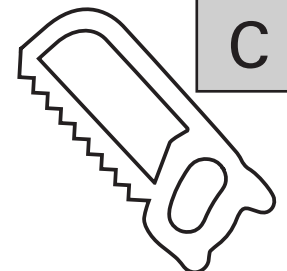
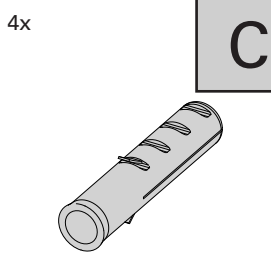
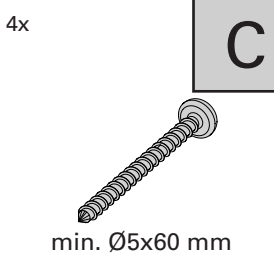
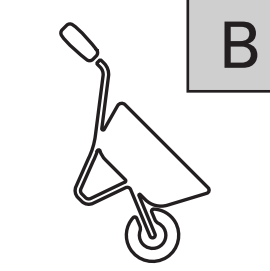
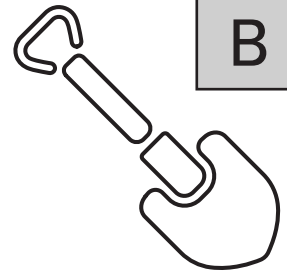
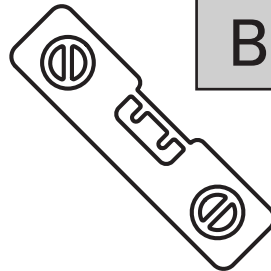
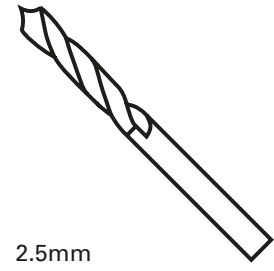
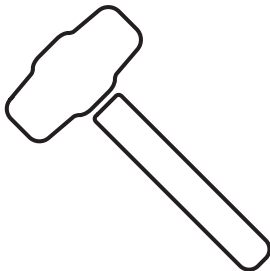
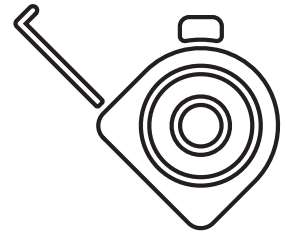
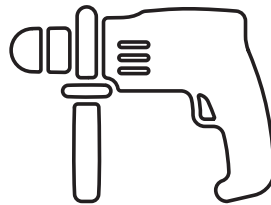
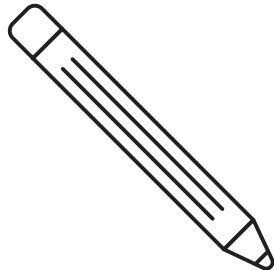
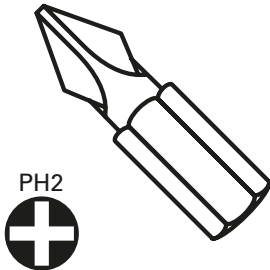
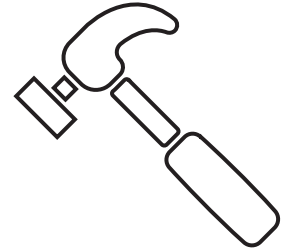
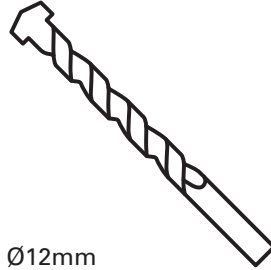
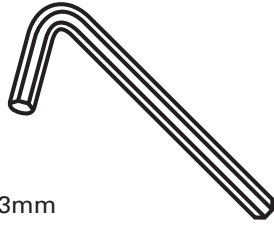
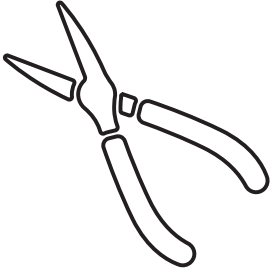

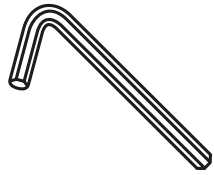
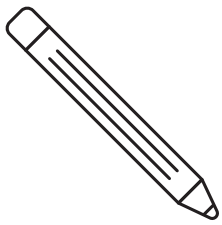

5mm

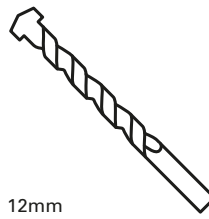
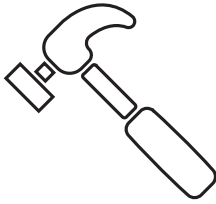

12mm

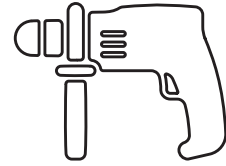

1

A

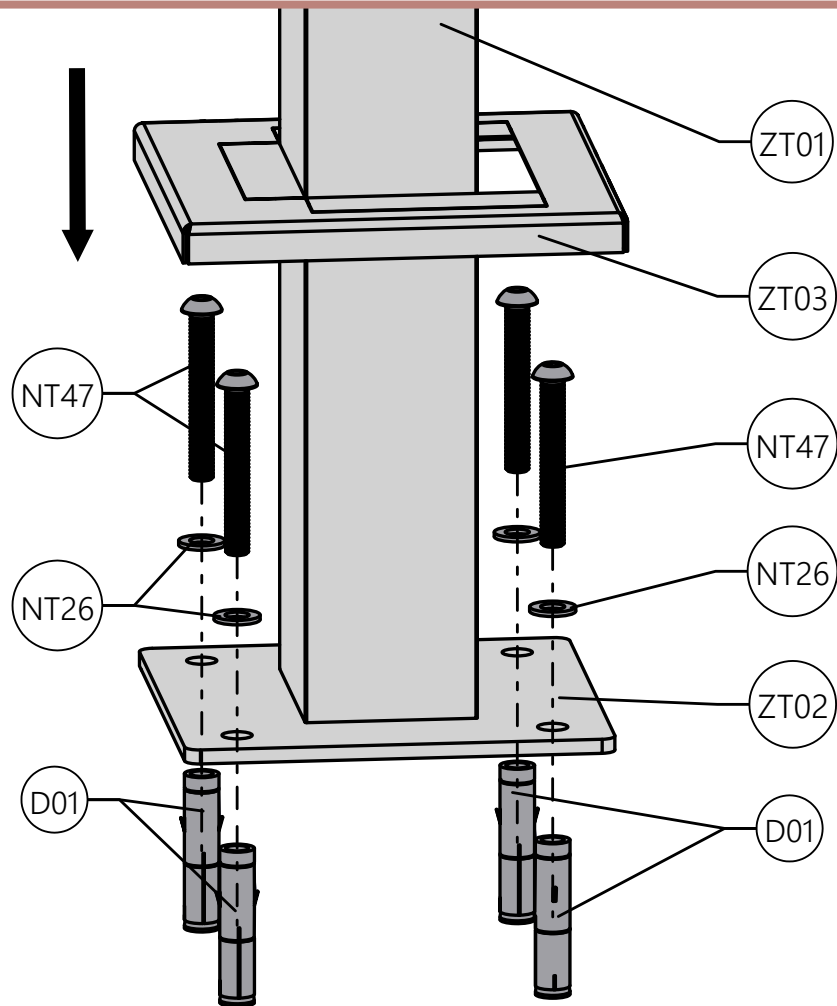
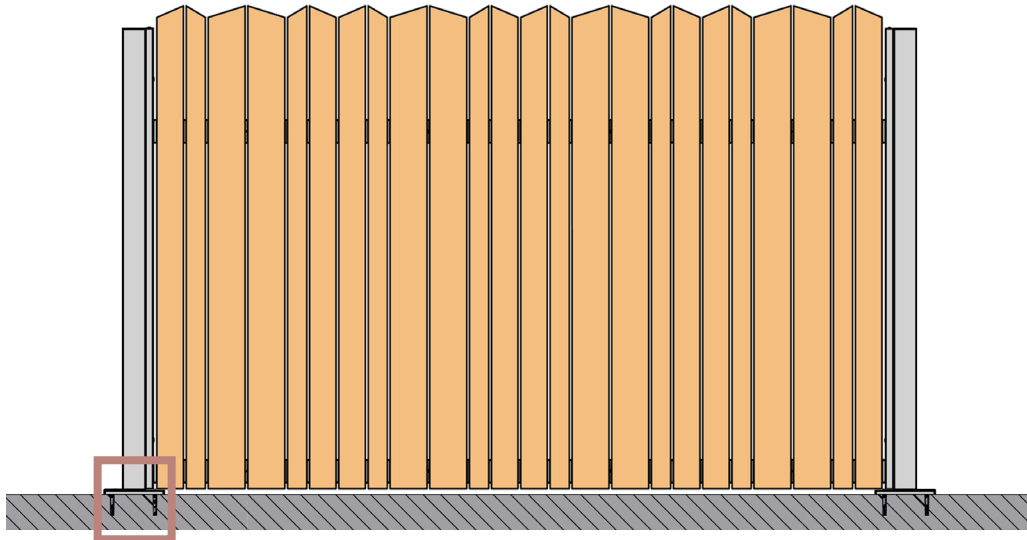

2

B

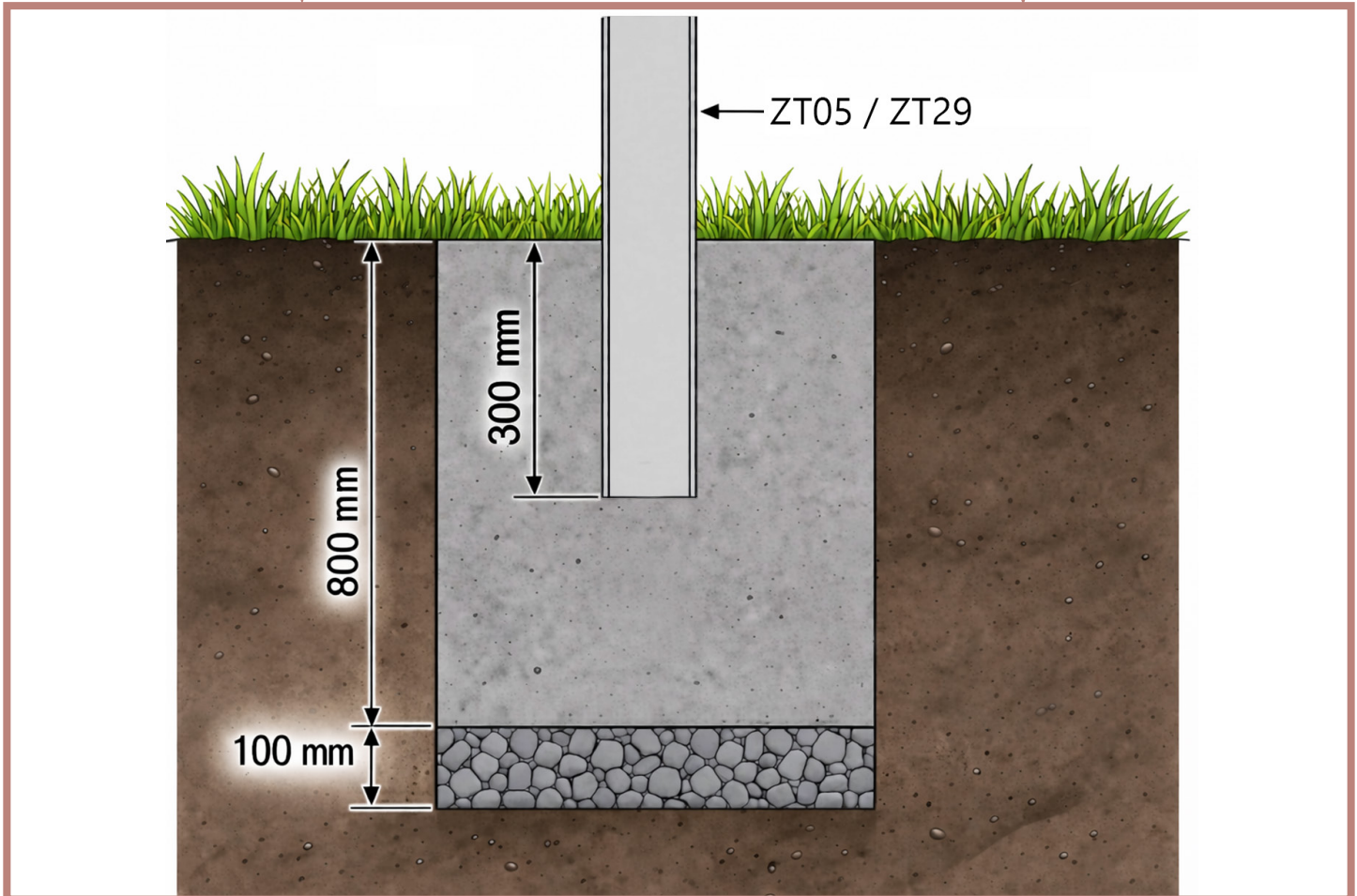
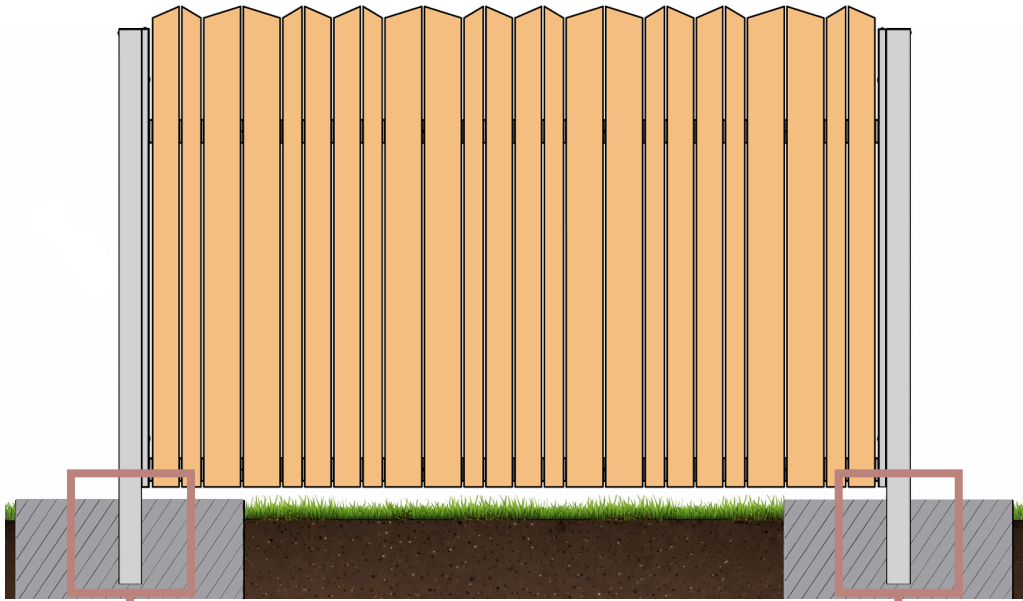
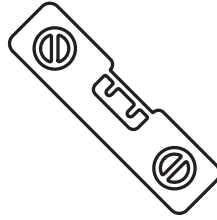
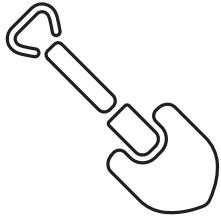

3

C

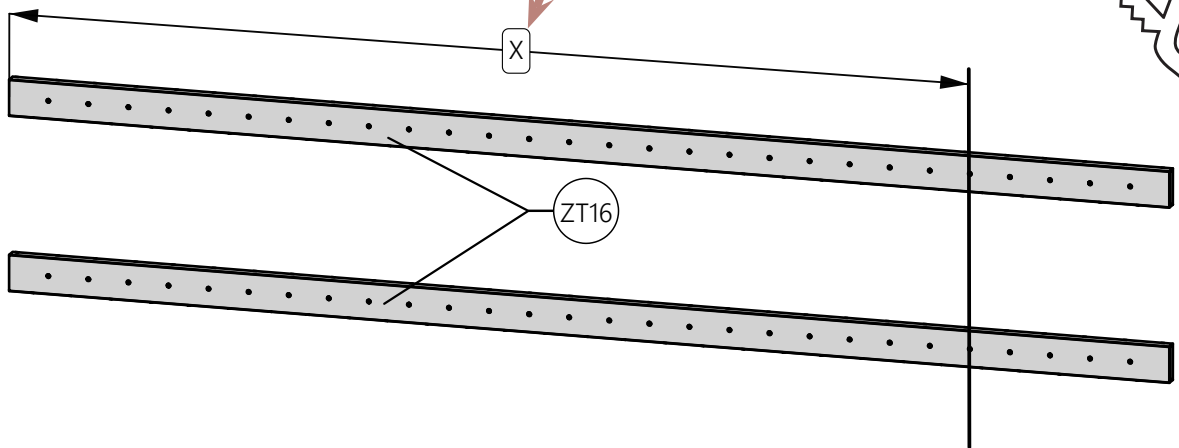
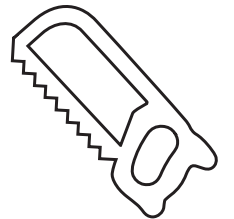
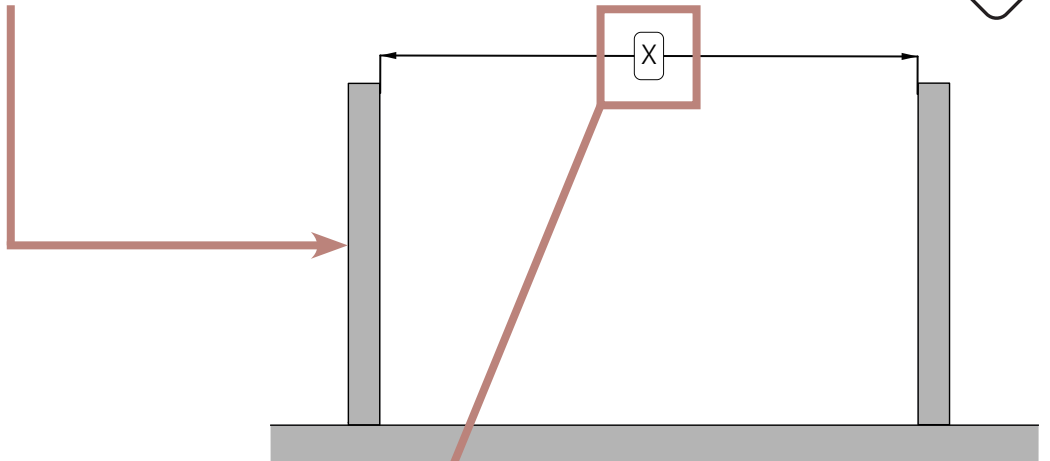
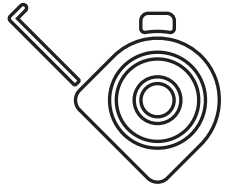
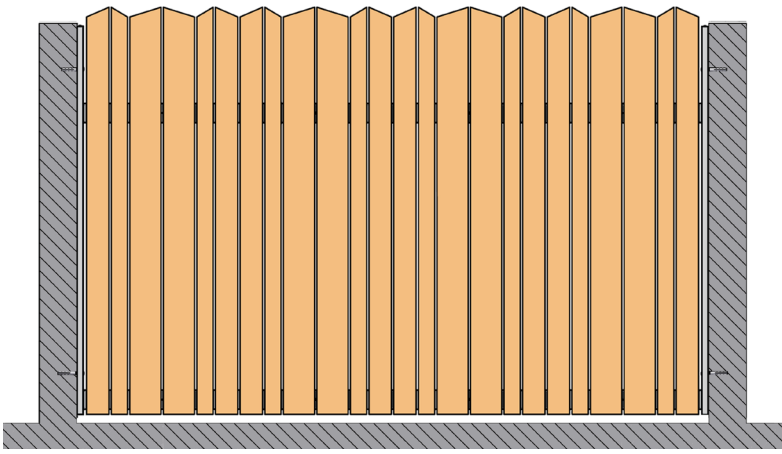

4

A

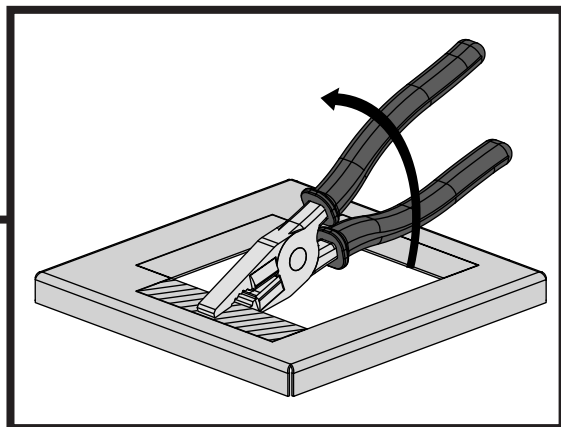
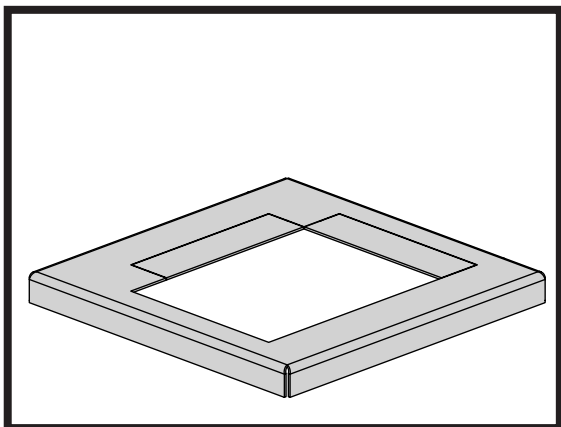
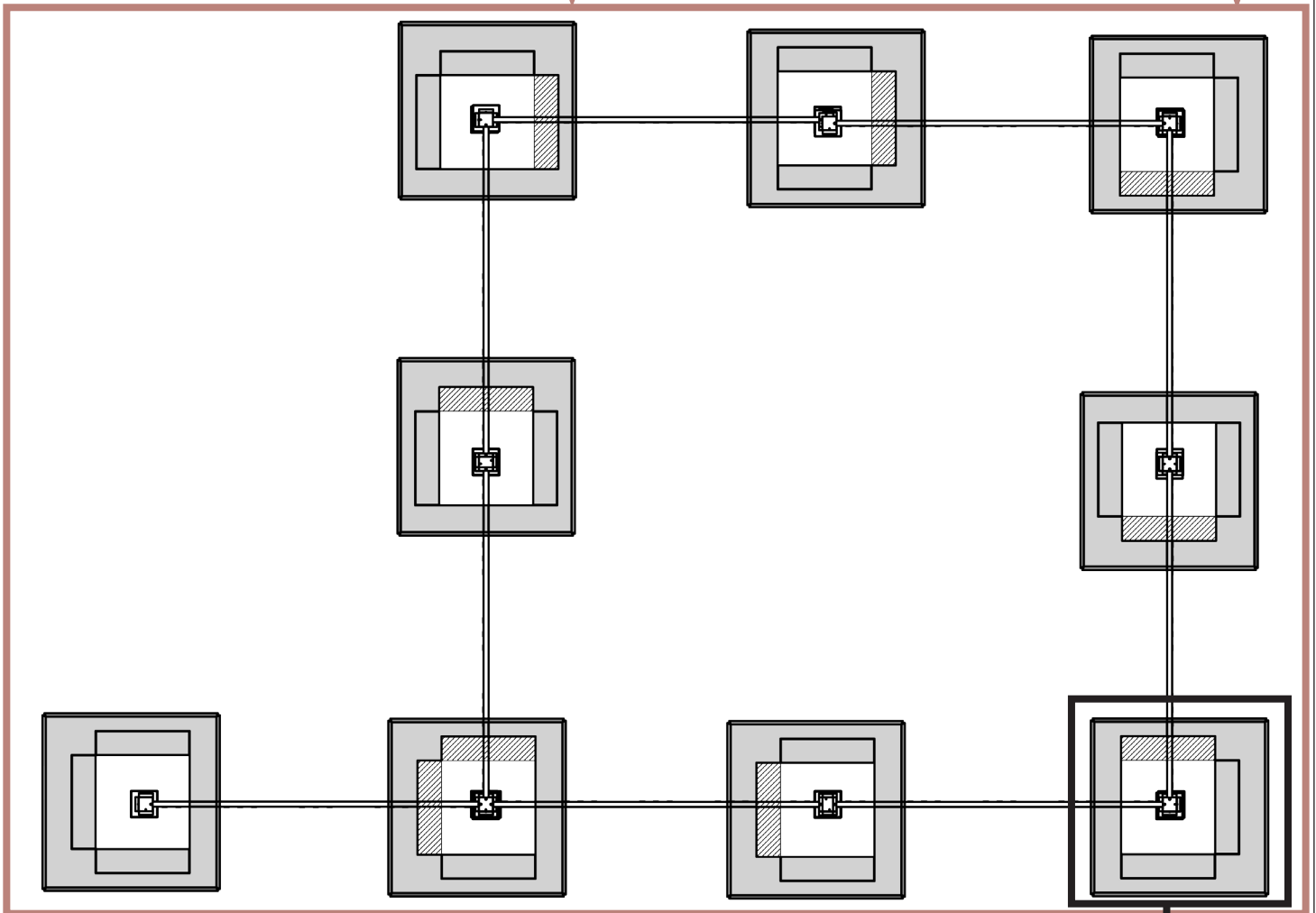
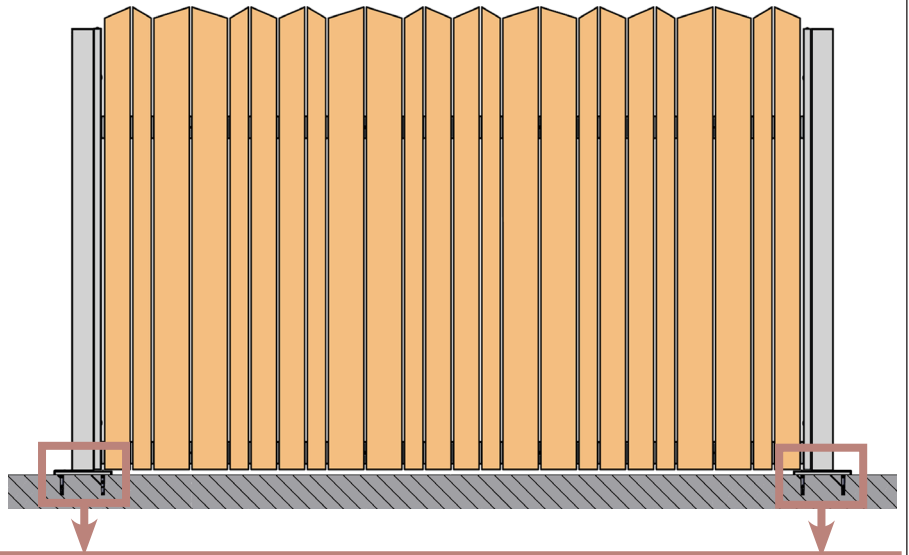

5

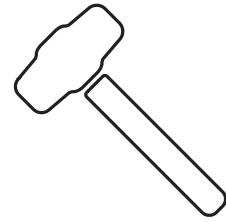

A

B

C

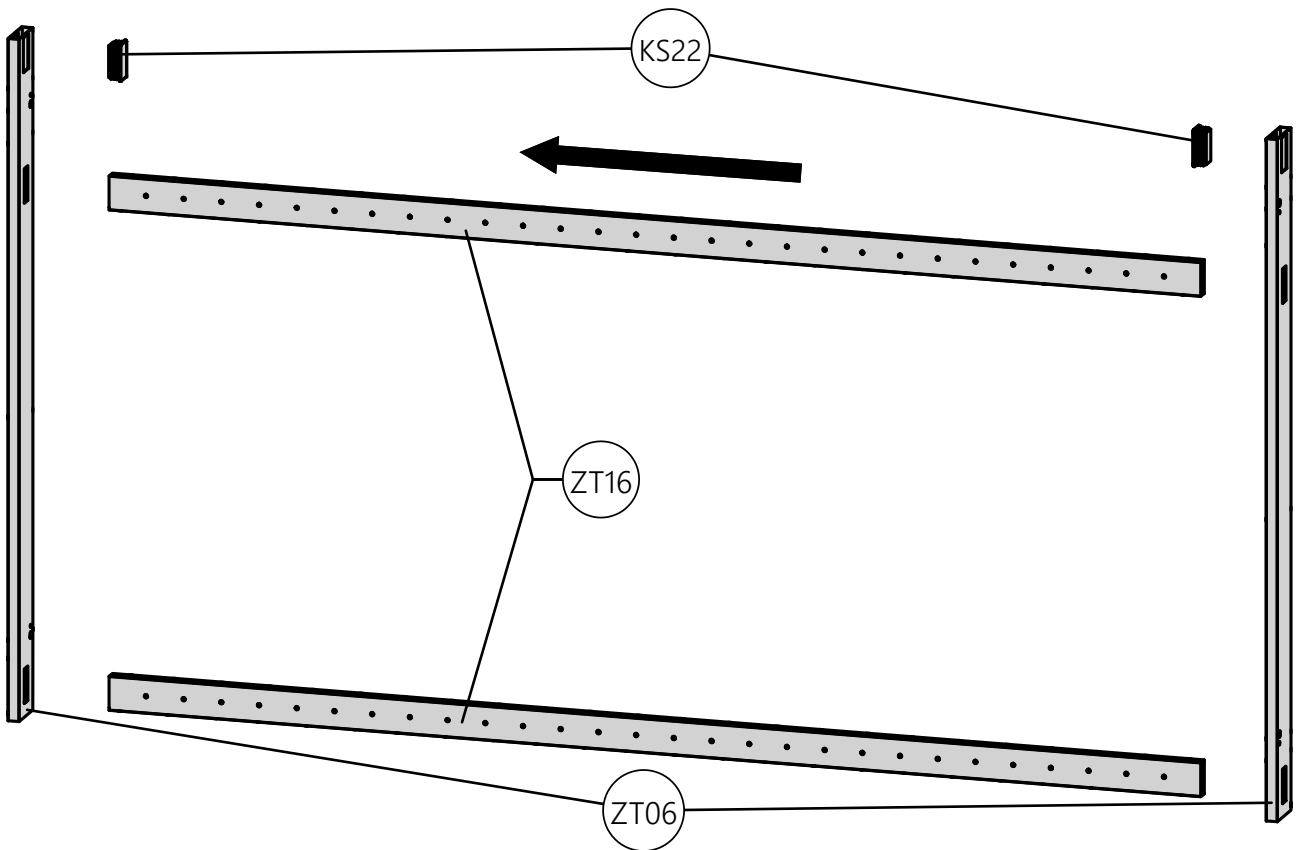
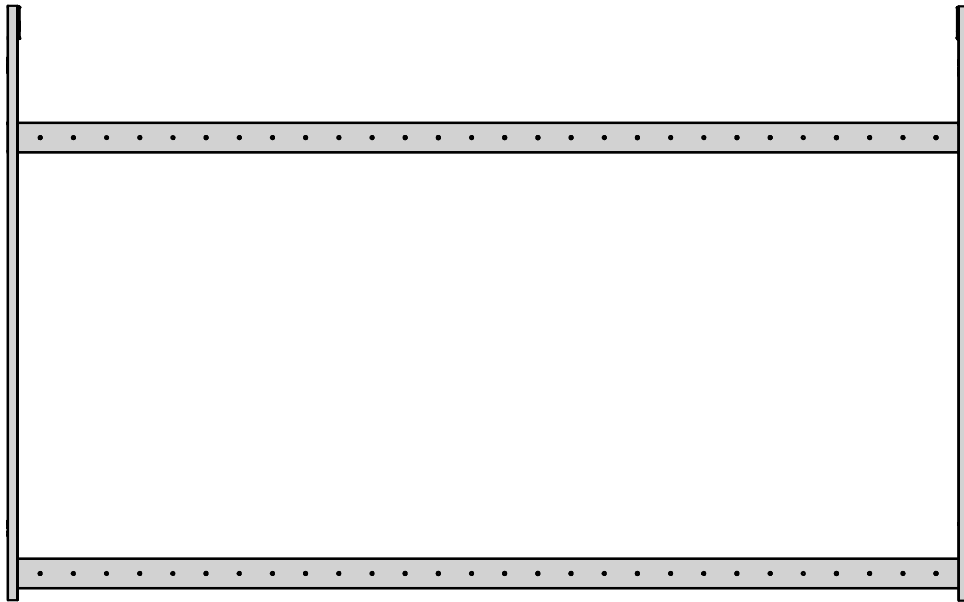

6

A

B

C

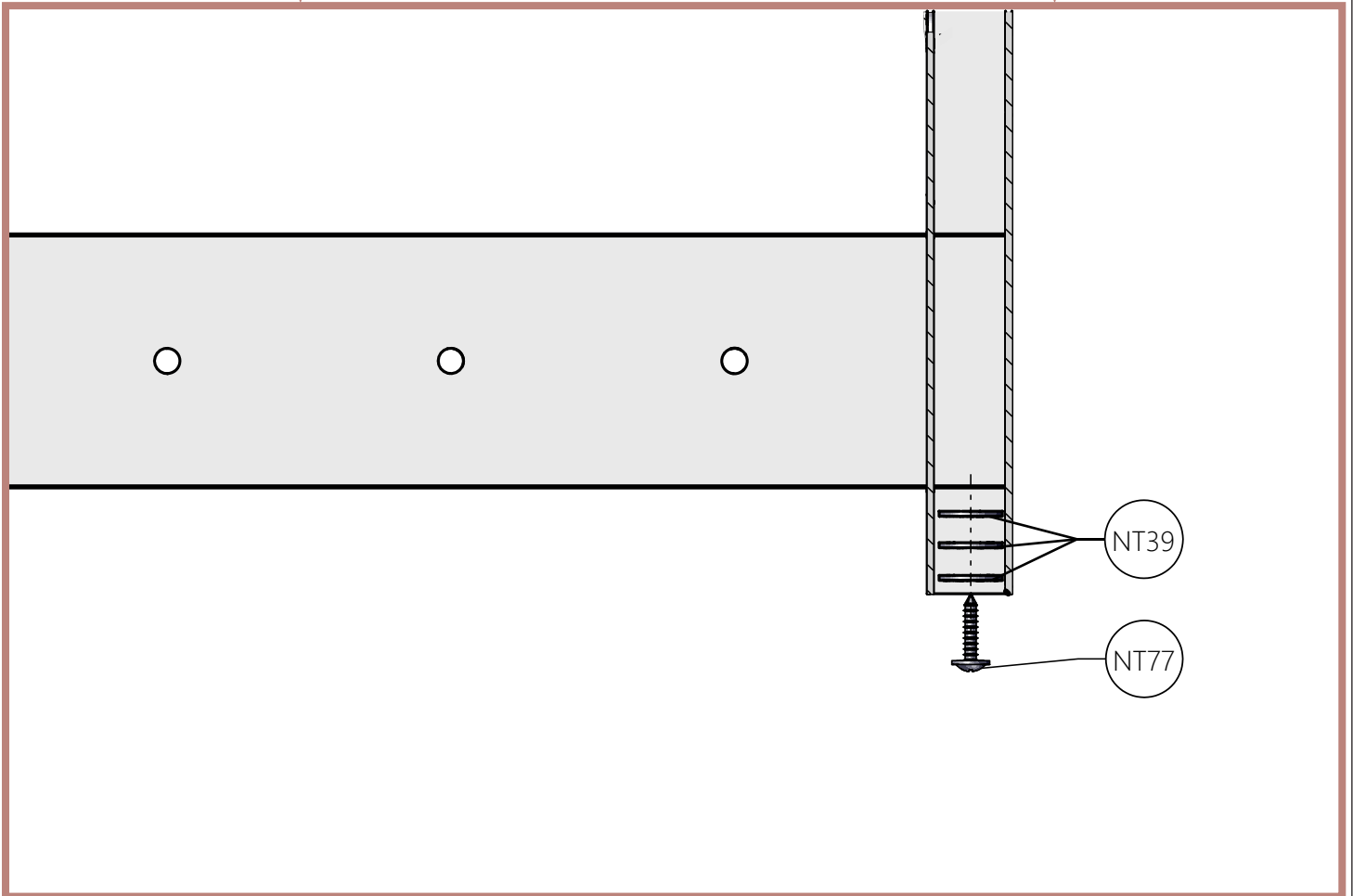
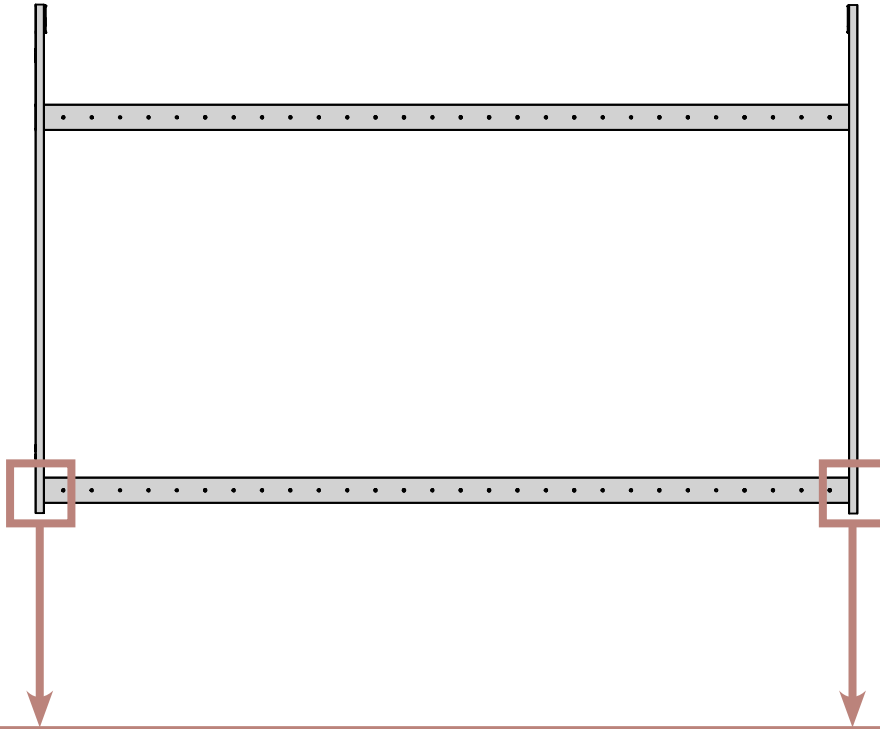
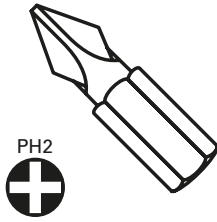

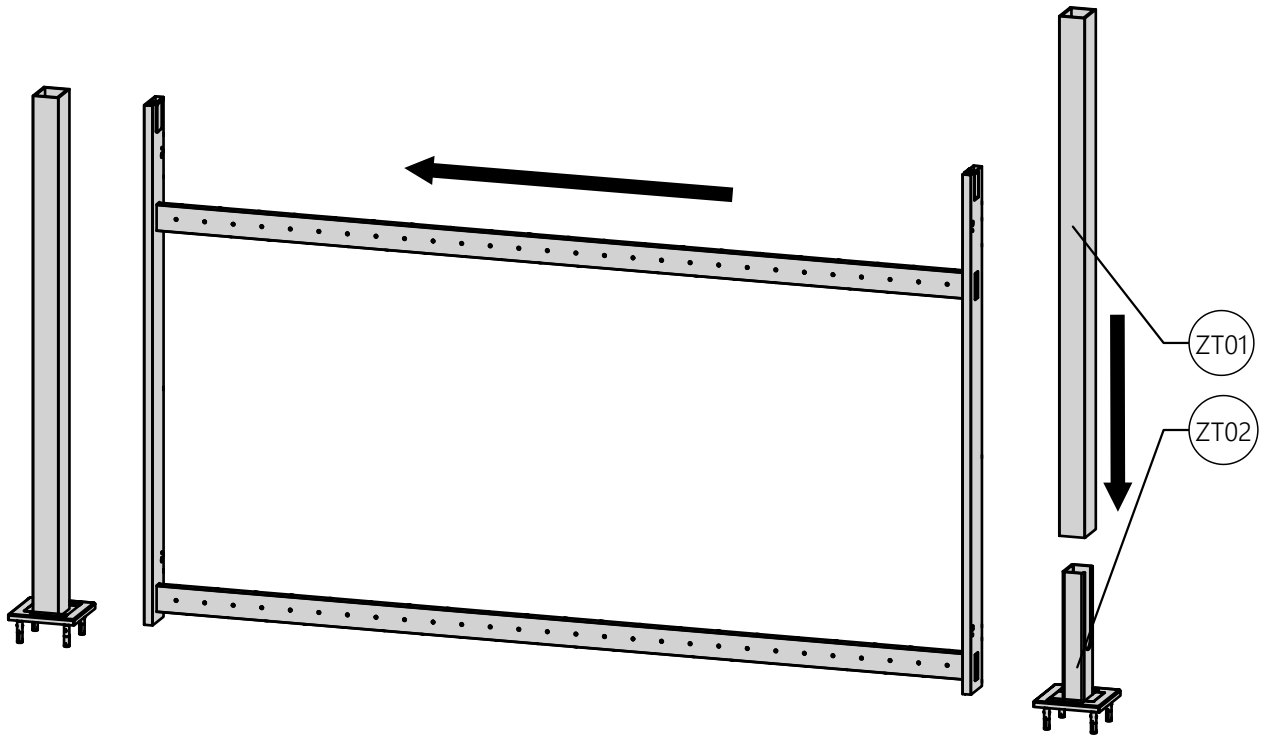
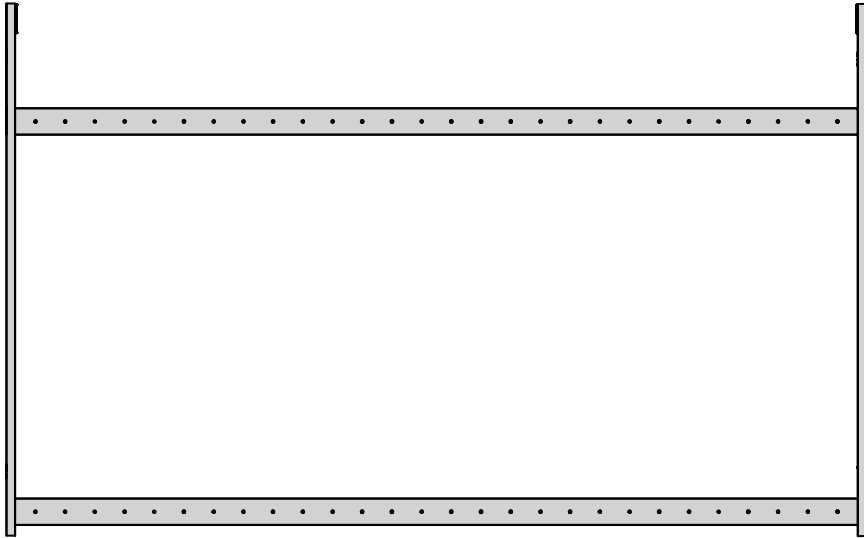

8

A

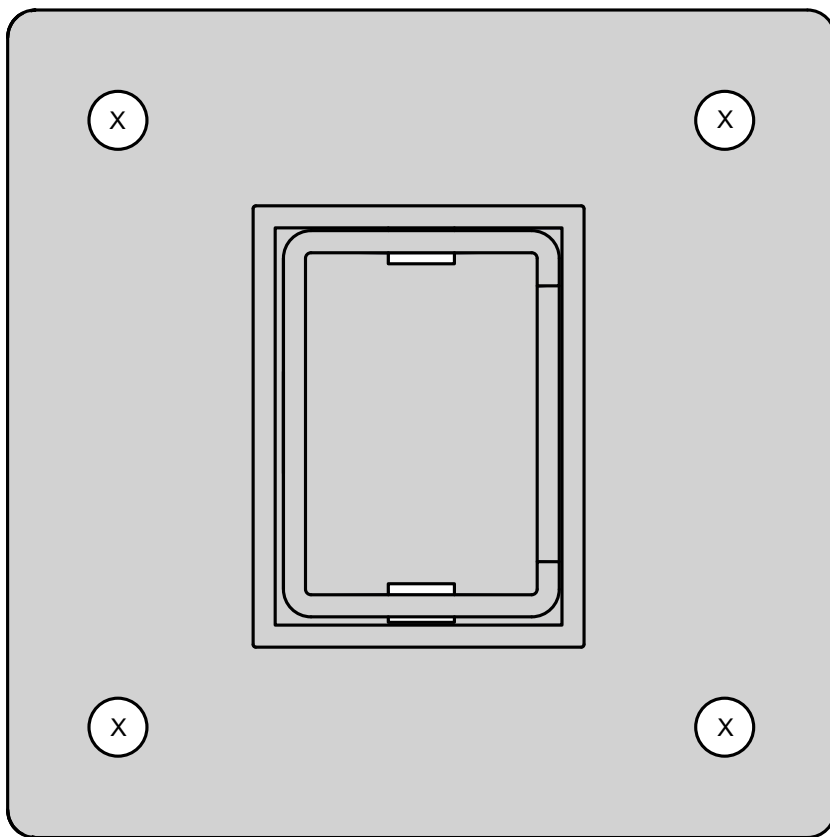
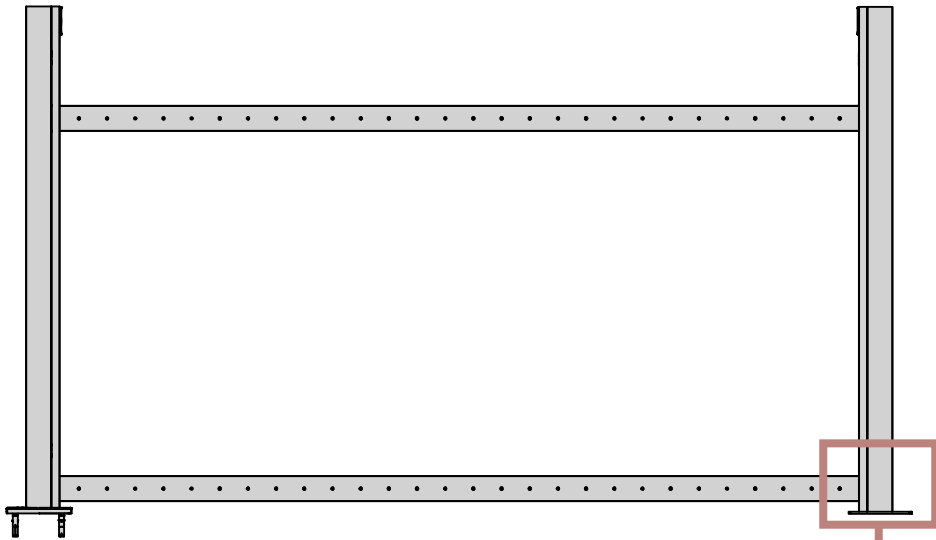
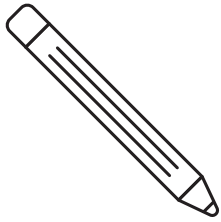

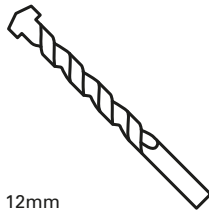
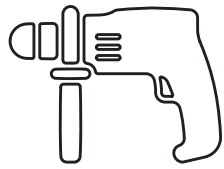

12mm

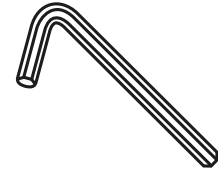
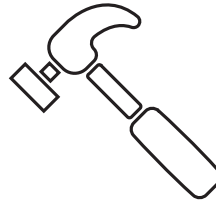

5mm

9

A

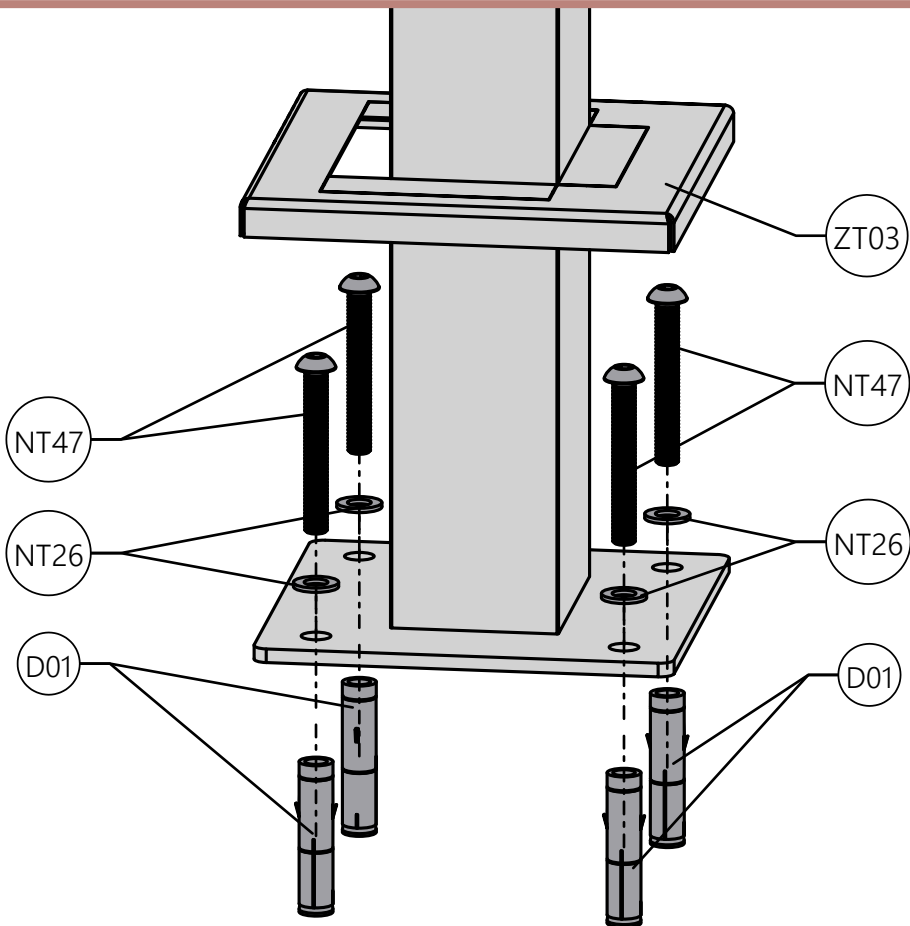
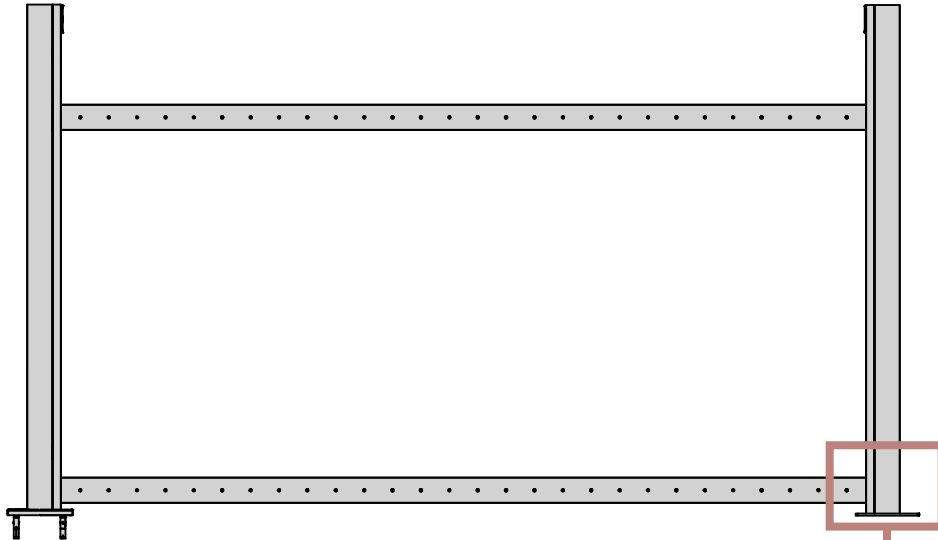

10

A

B

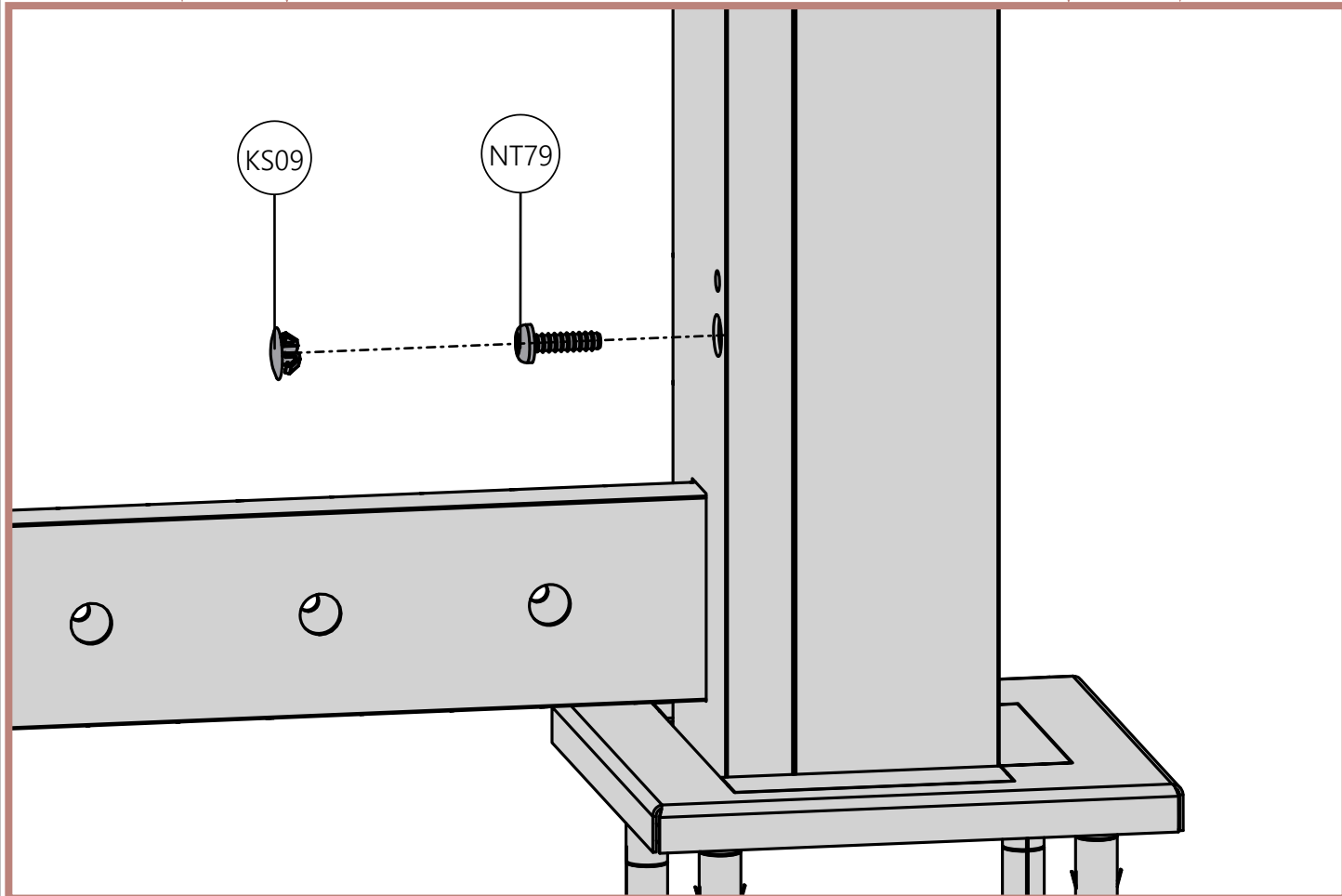
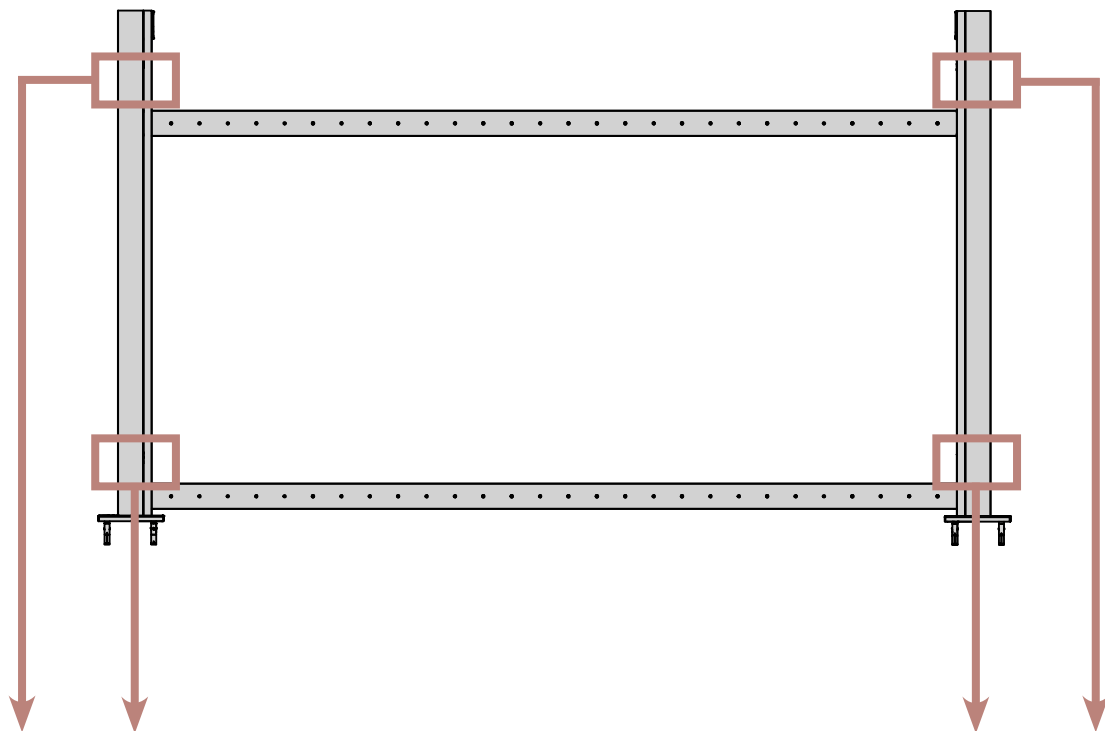
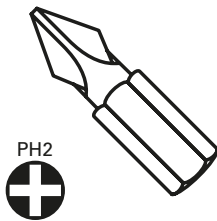

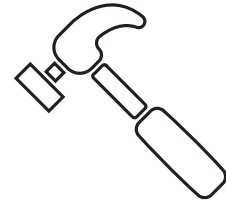
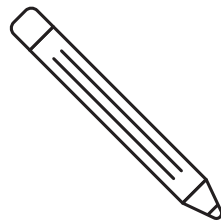
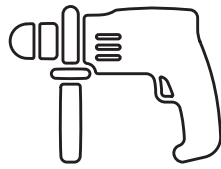
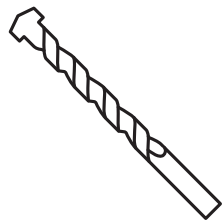

11

C

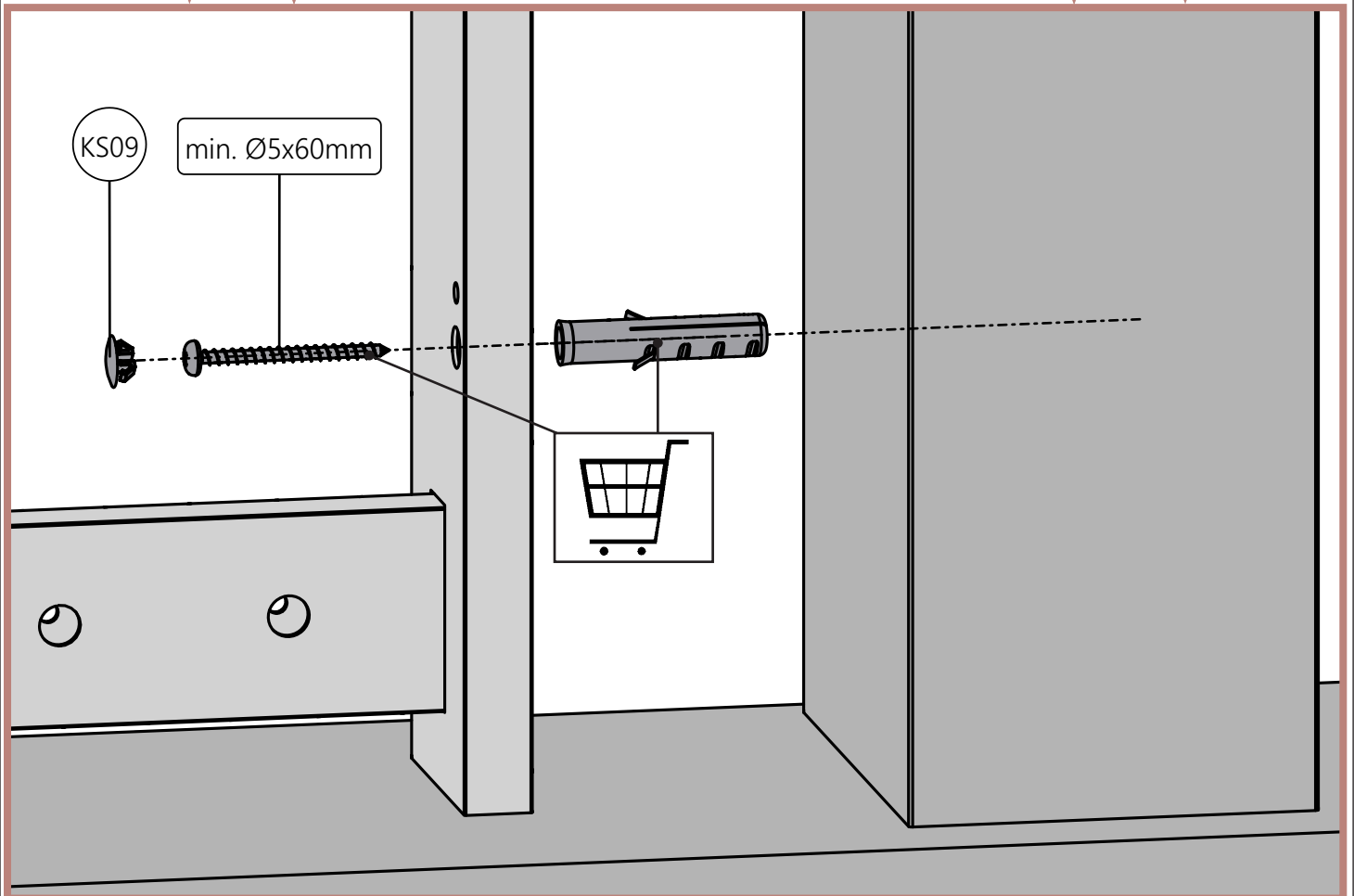
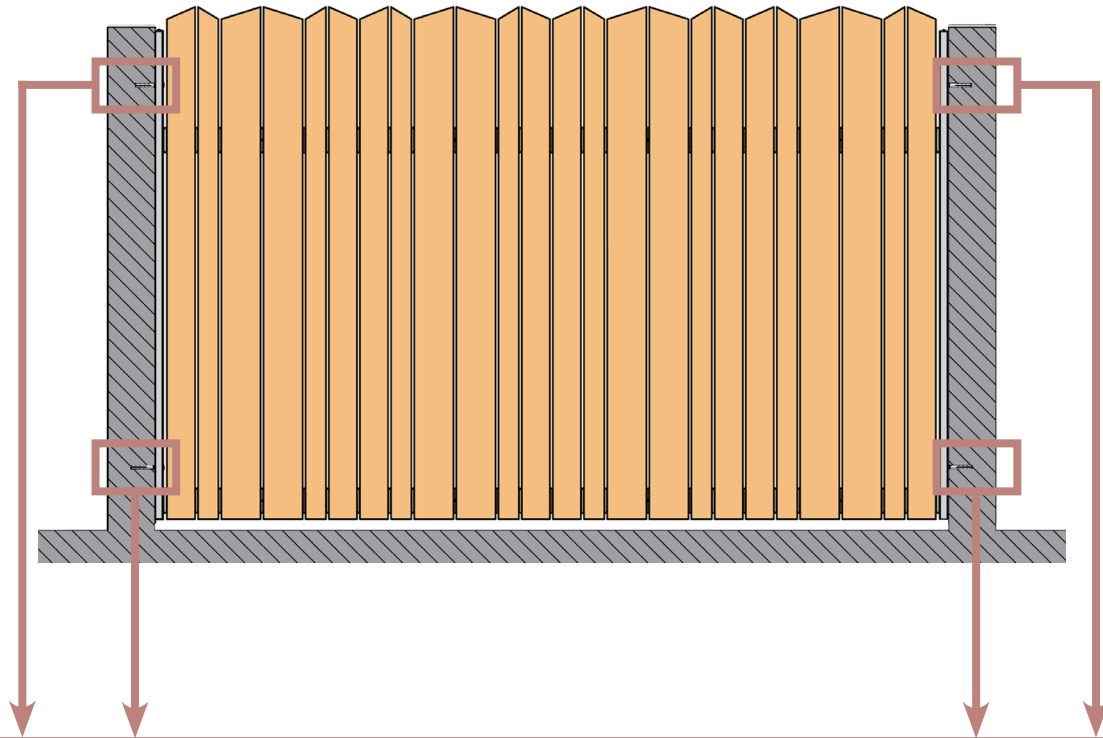

12

A

B

C

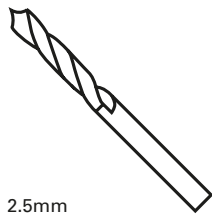

2.5mm

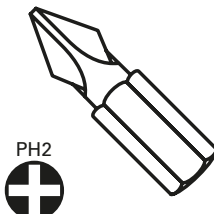
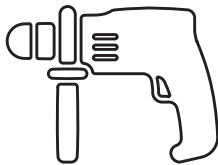

PH2

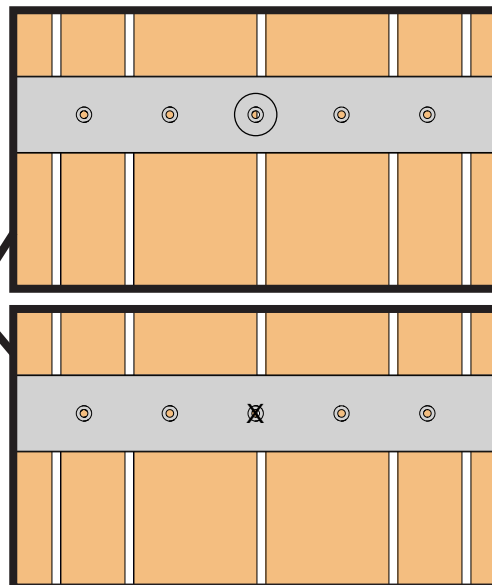
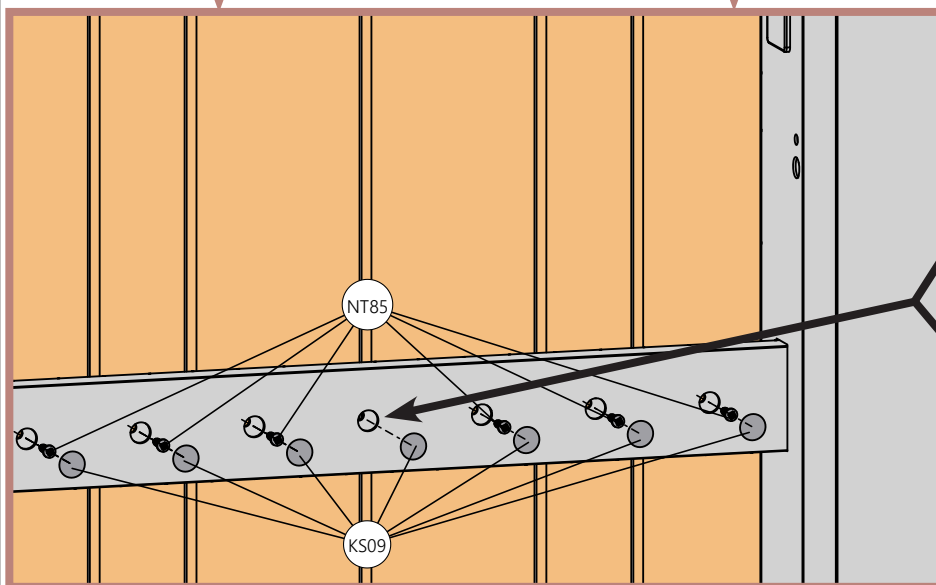
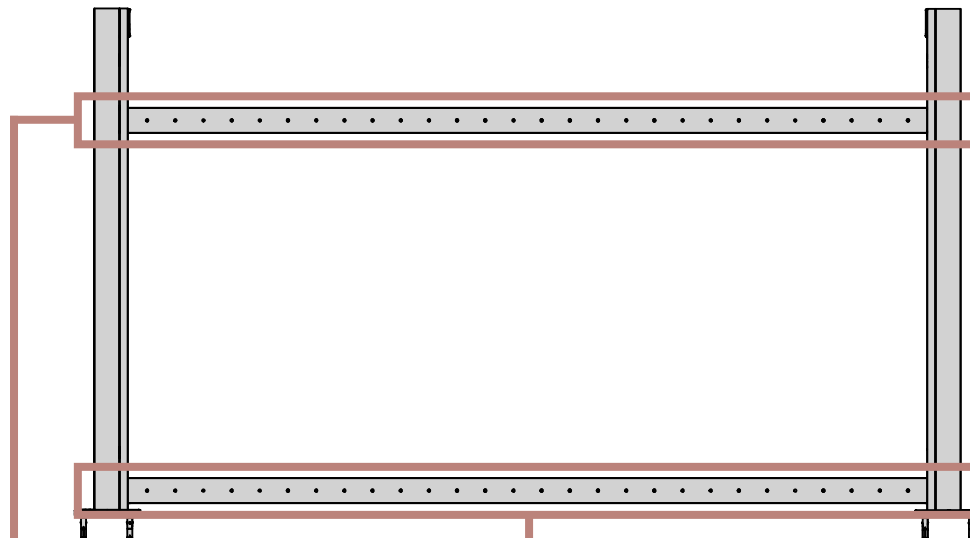
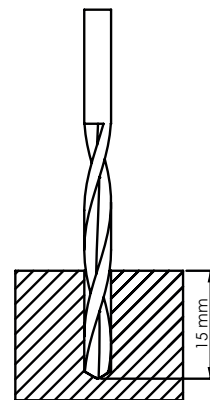

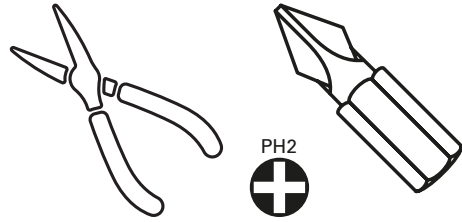

A  
B

