

STRATA 120



A



B



C



STRATA 120

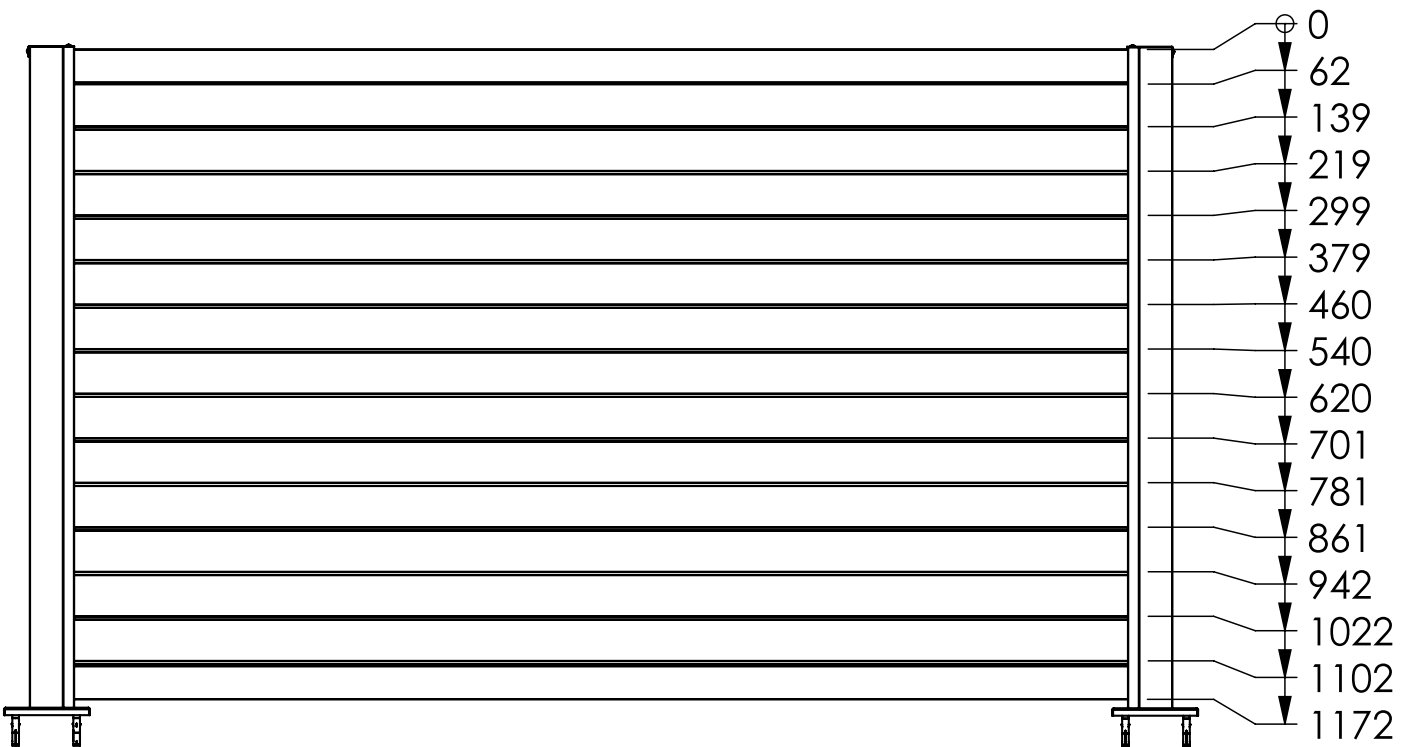
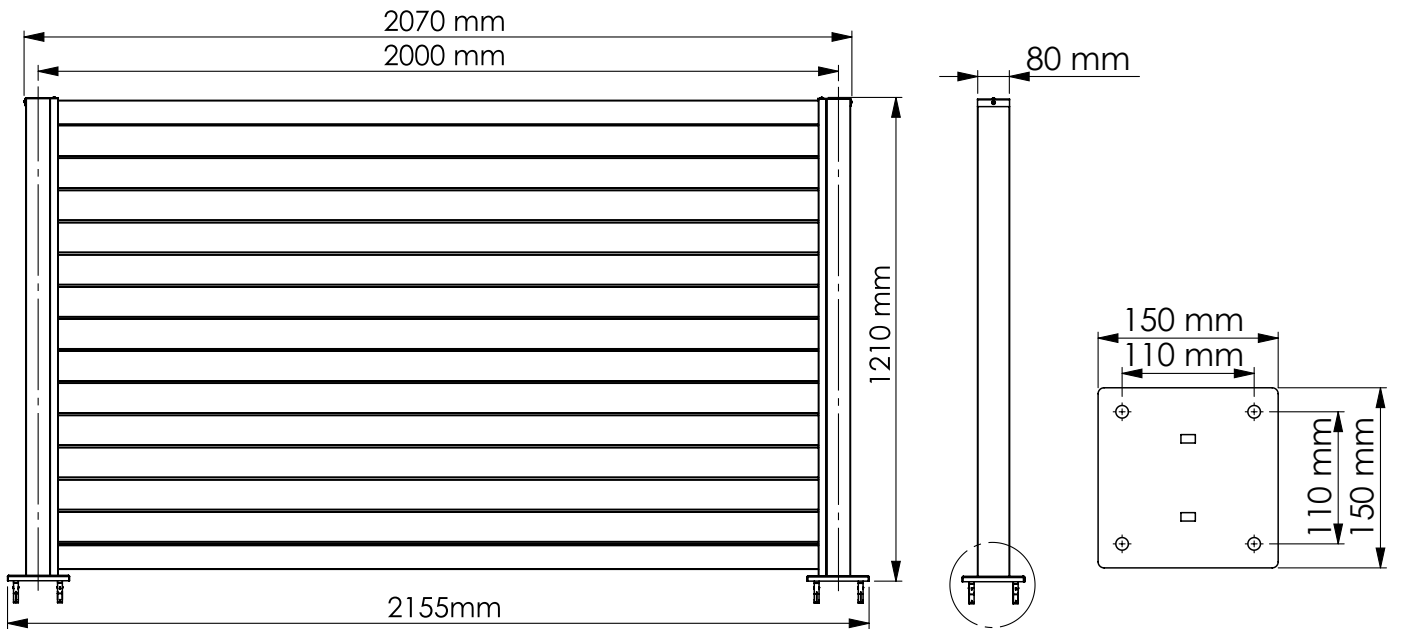

STRATA 120



8x

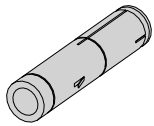

D01

M8x55 mm

4x

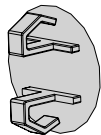

KS09

Ø13 mm

8x

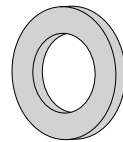

NT26

M8 DIN125A

12x

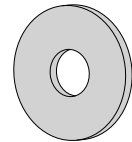

NT39

M5 DIN9021

8x

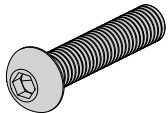

NT47

M8x60 mm ISO7380-1

6x

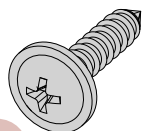

NT77

3,5x16 mm

4x

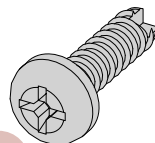

NT79

Ø5,5x22 mm

2x

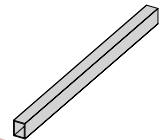

ZT01

80x60x1200 mm

2x

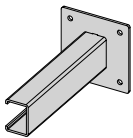

ZT02

2x

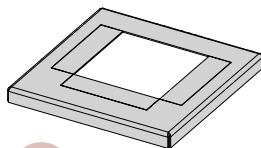

ZT03

2x

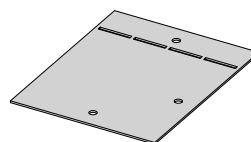

ZT04

2x

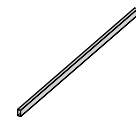

ZT07

60x30x1940 mm

2x

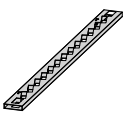

ZT43

80x20x1200 mm

13x

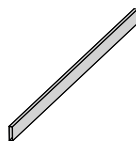

ZT51

80x20x1940 mm

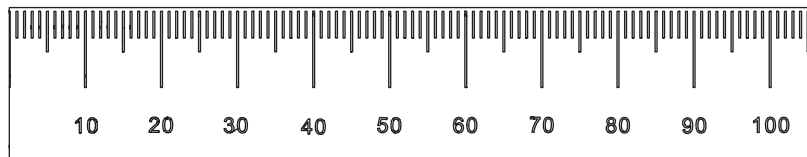
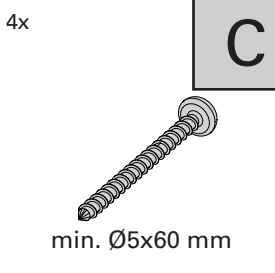
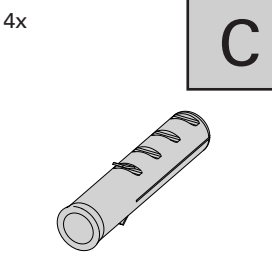
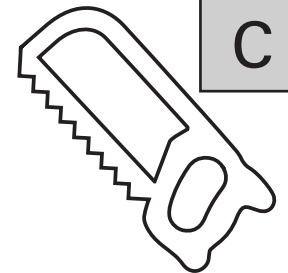
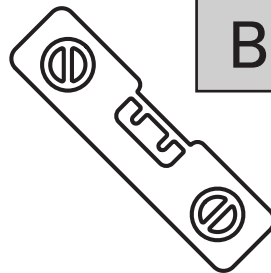
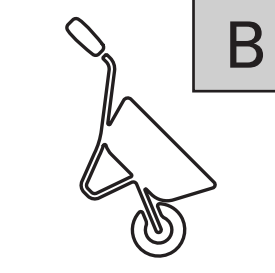
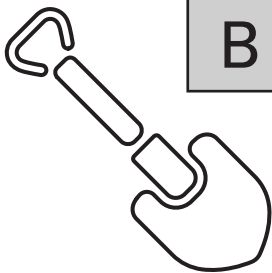
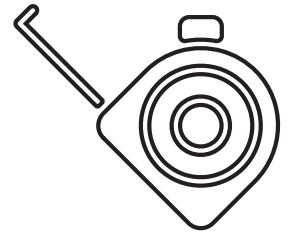
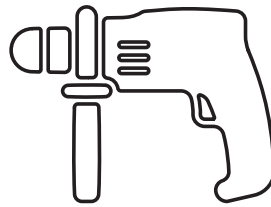
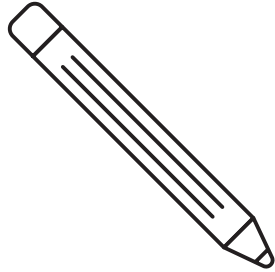
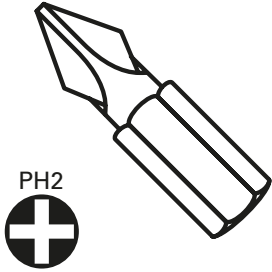
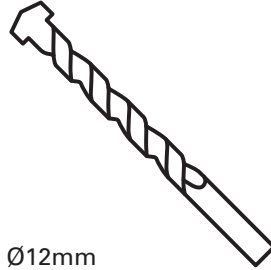
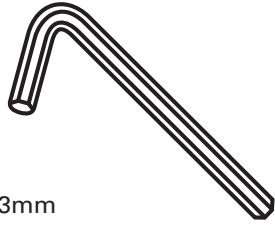
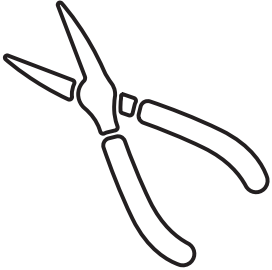

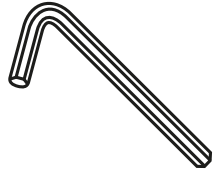
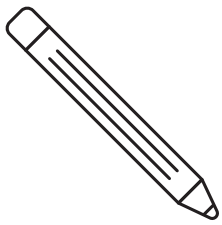

5mm

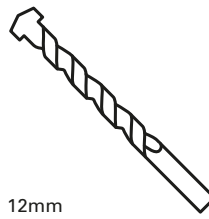
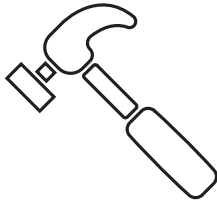

12mm

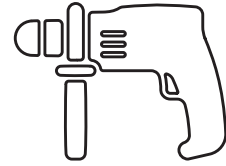

1

A

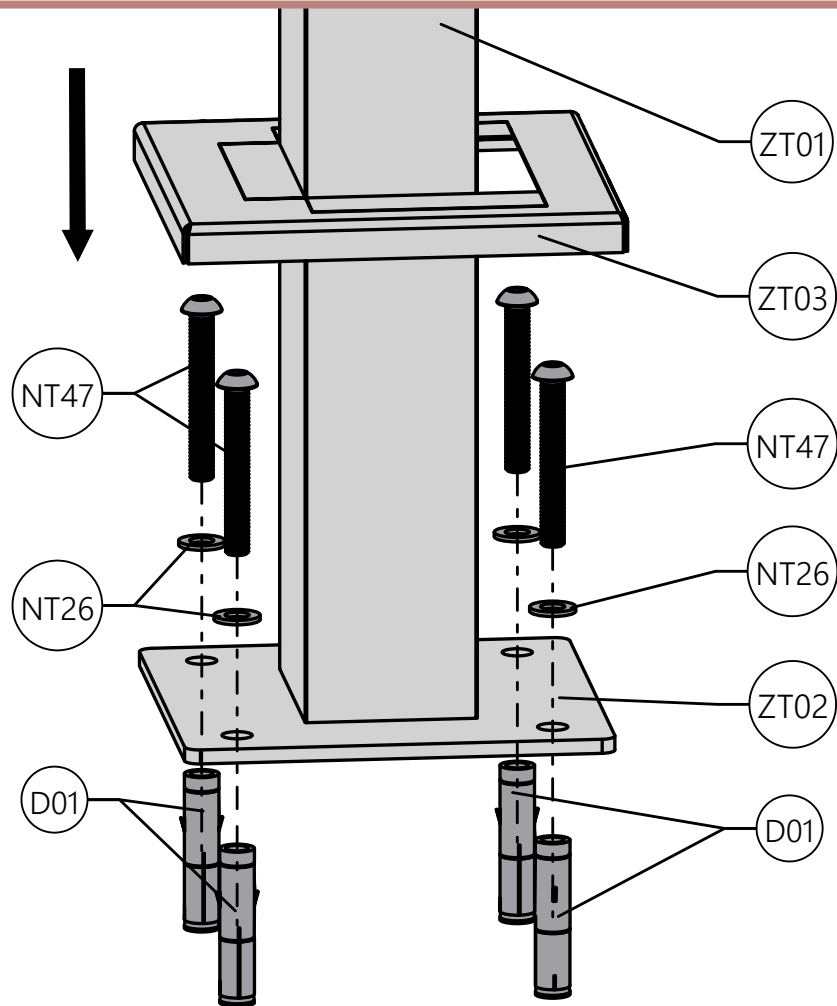
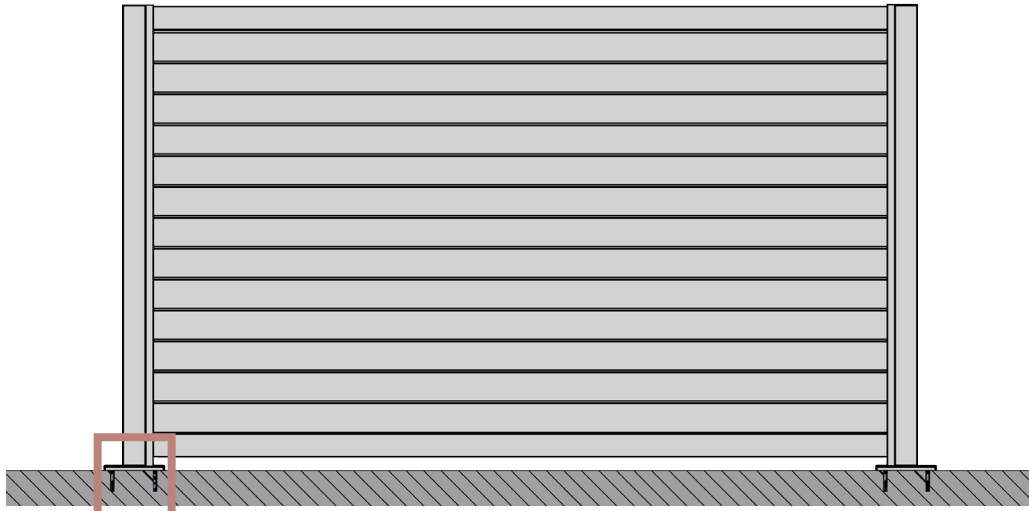

2

B

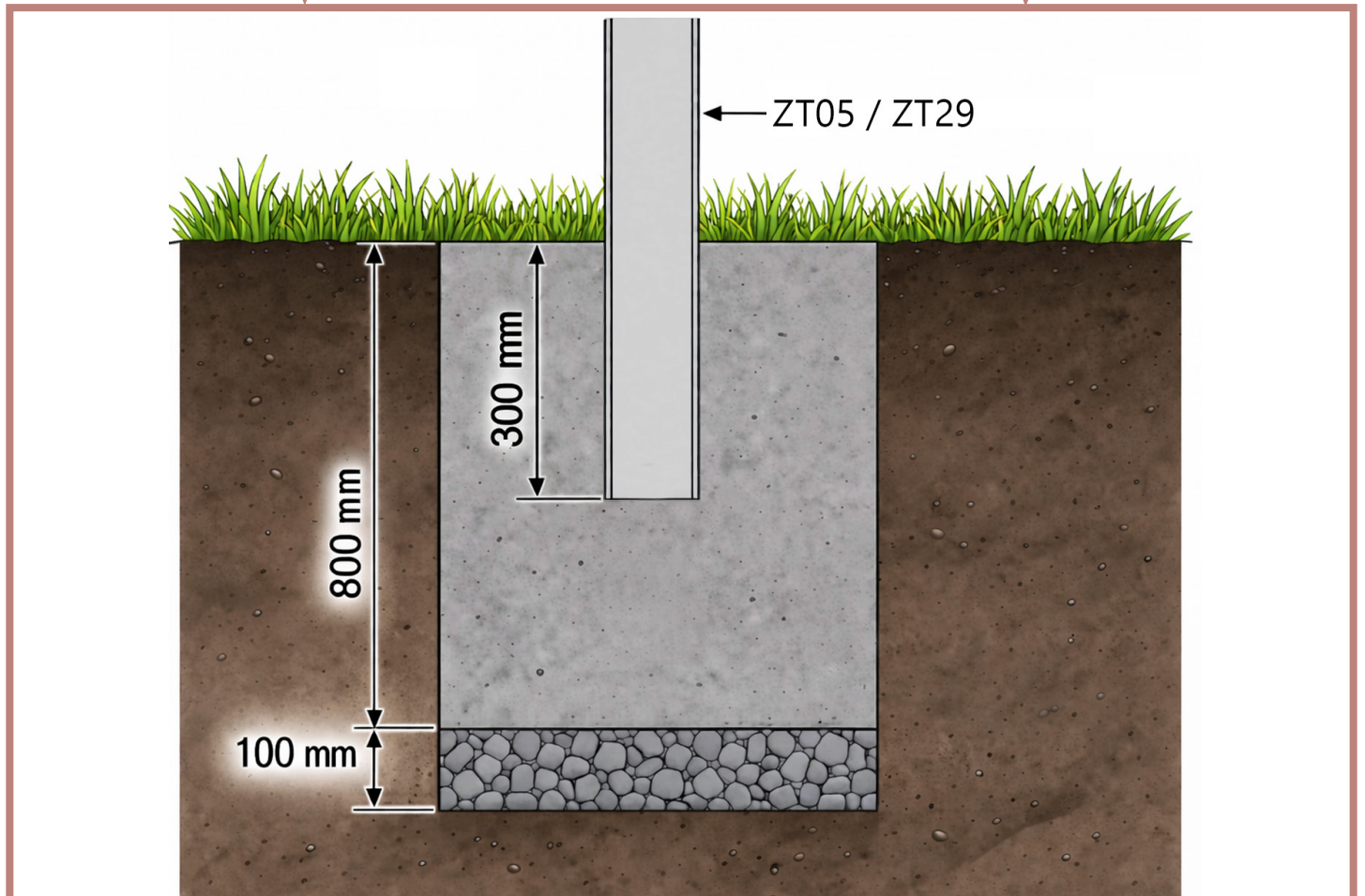
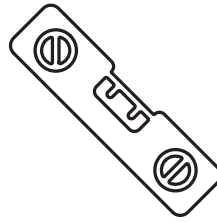

3

C

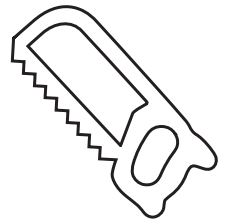
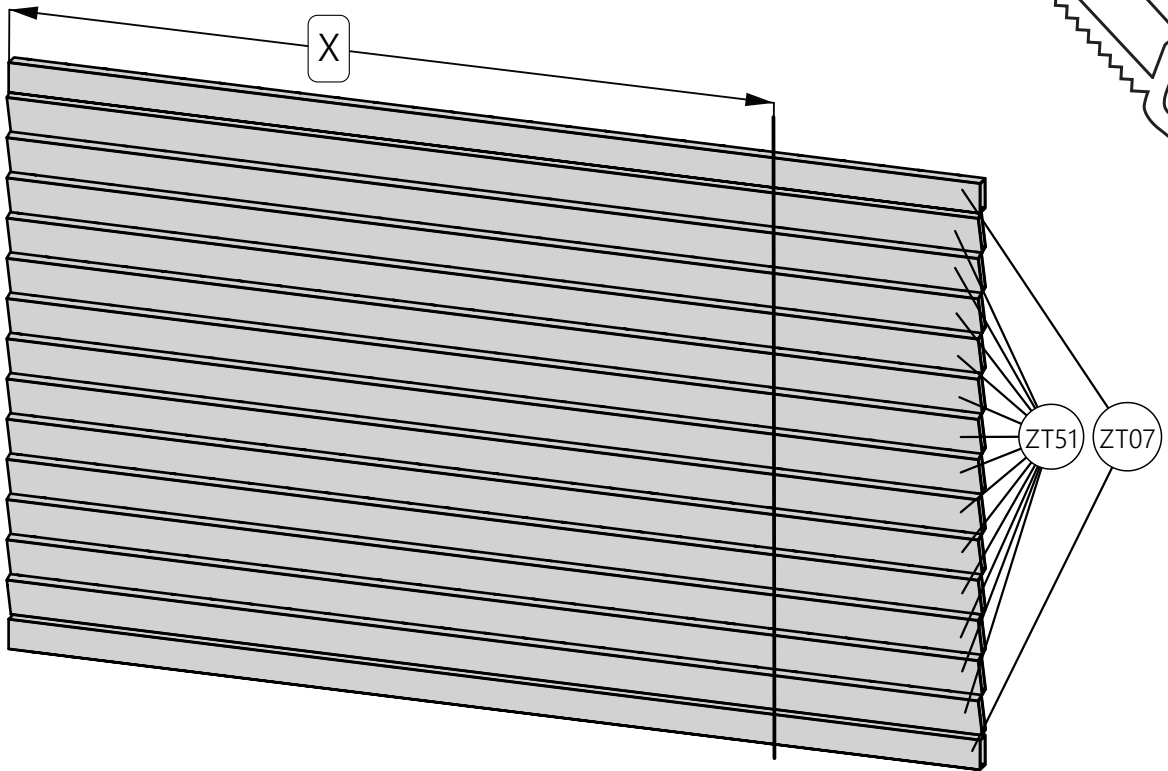
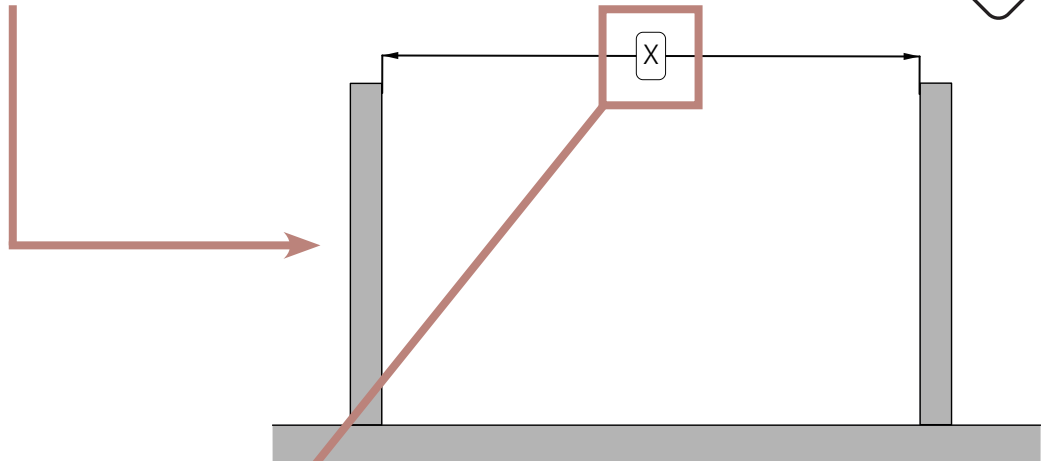
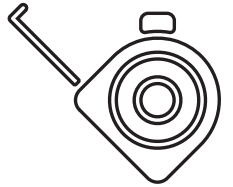

4

A

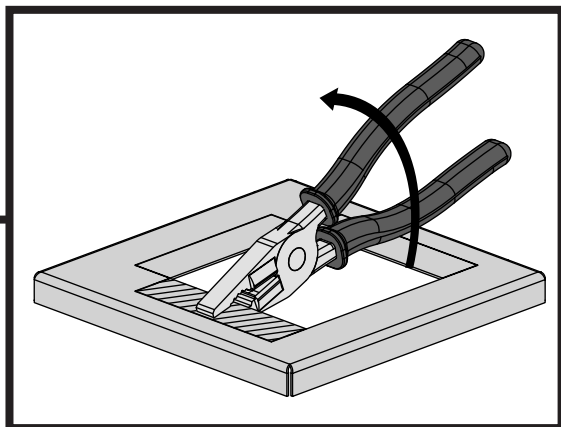
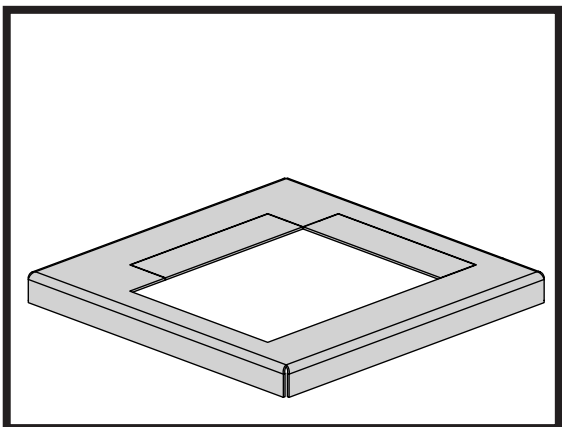
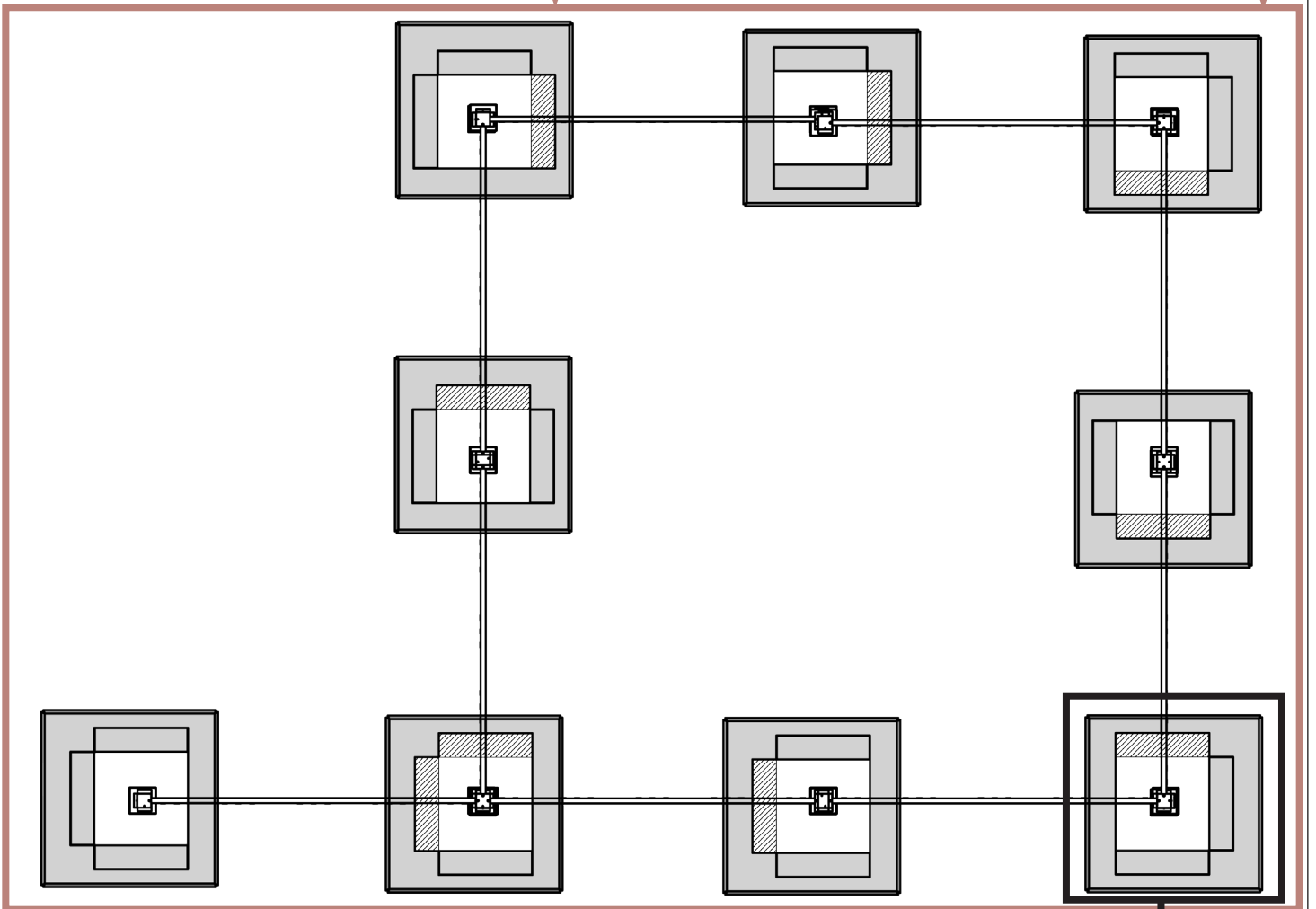
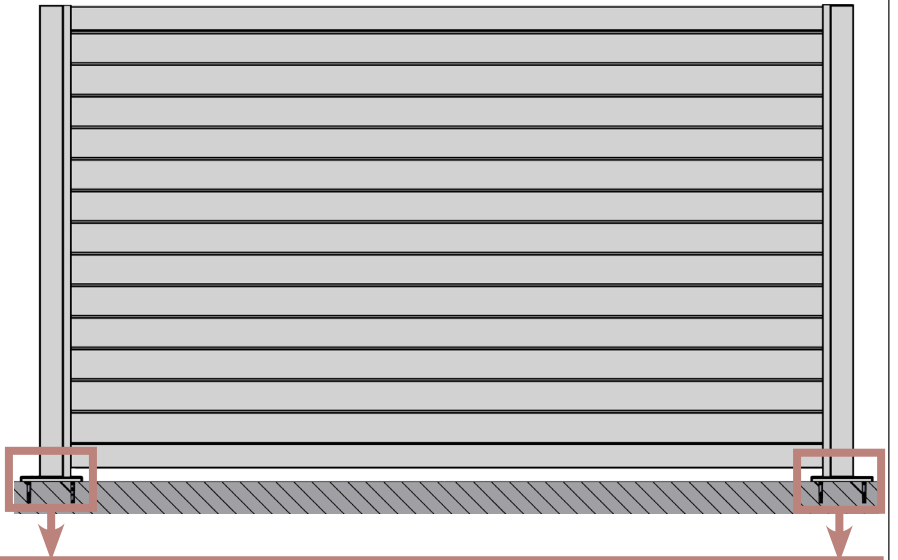

5

A

B

C

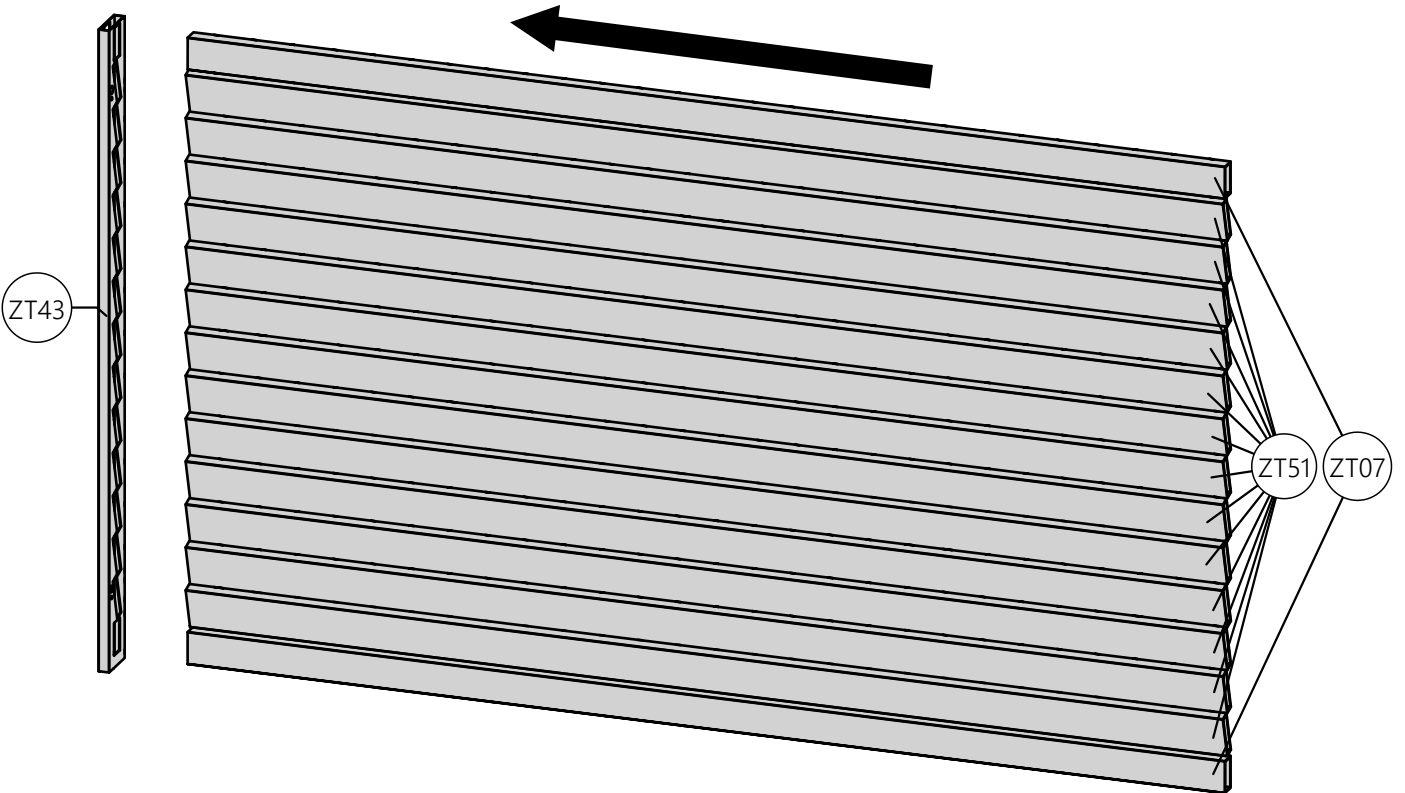

6

A

B

C

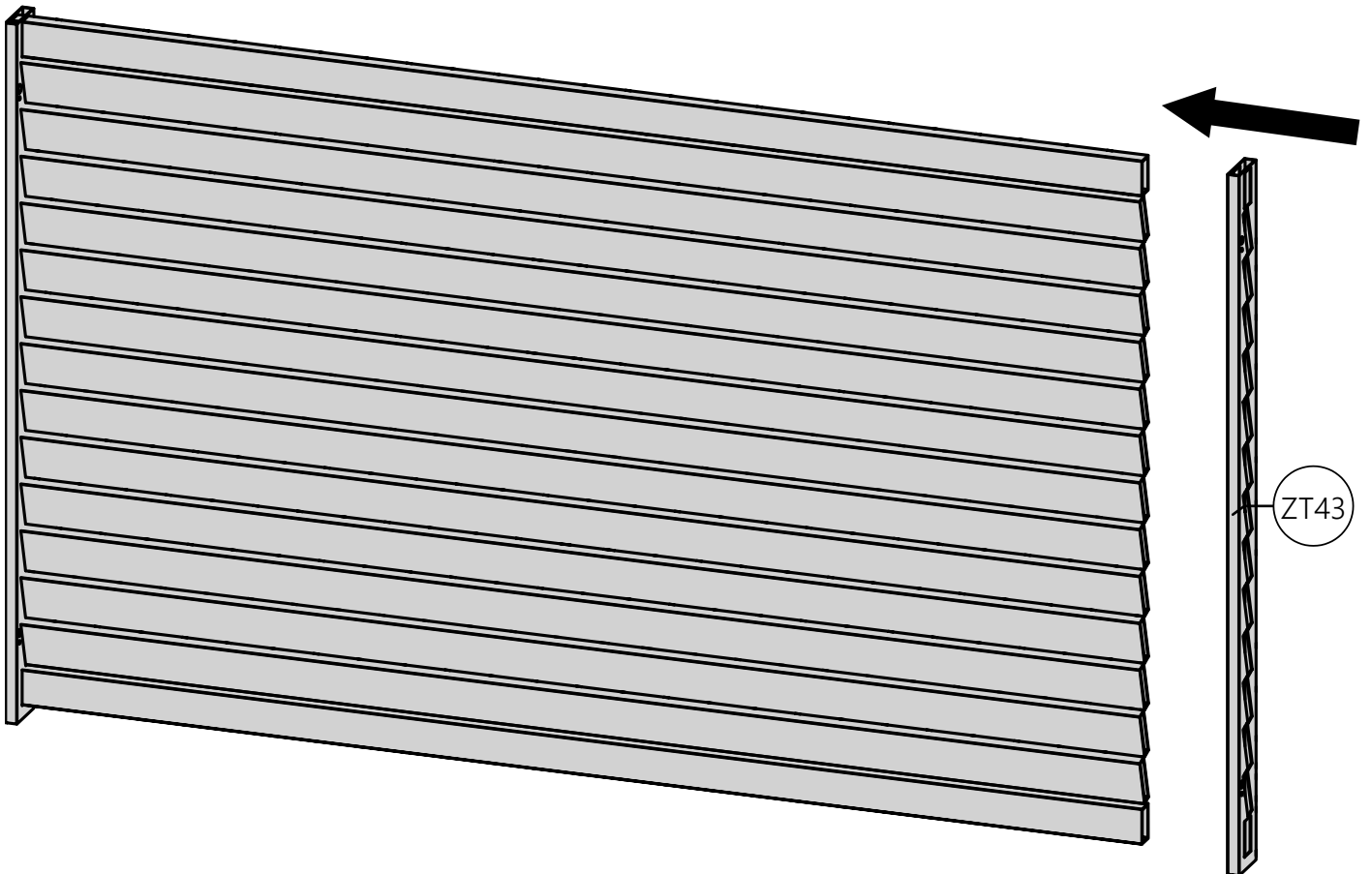

7

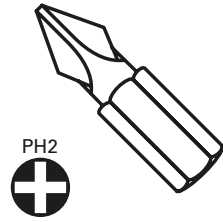

PH2

A

B

C

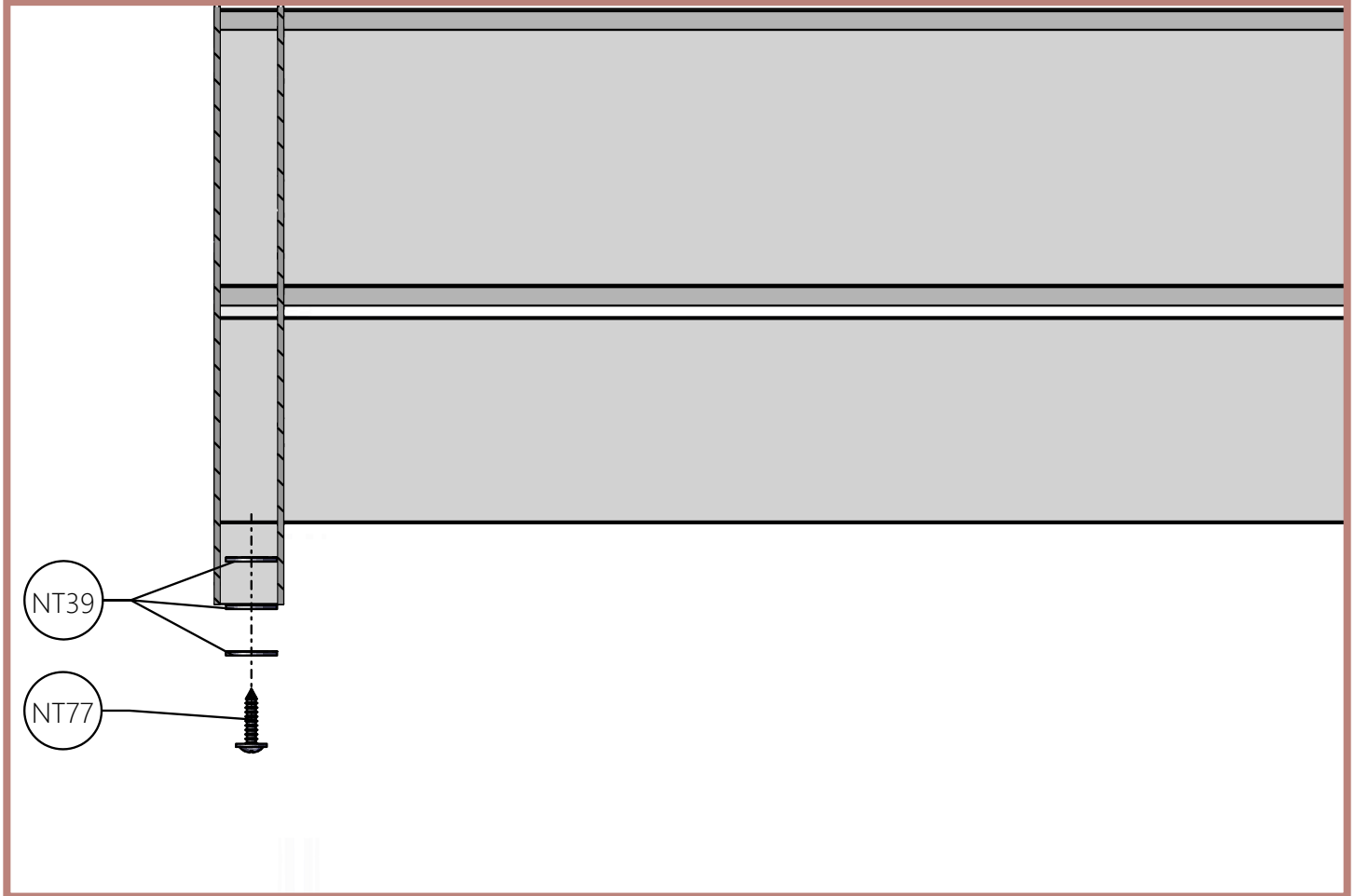
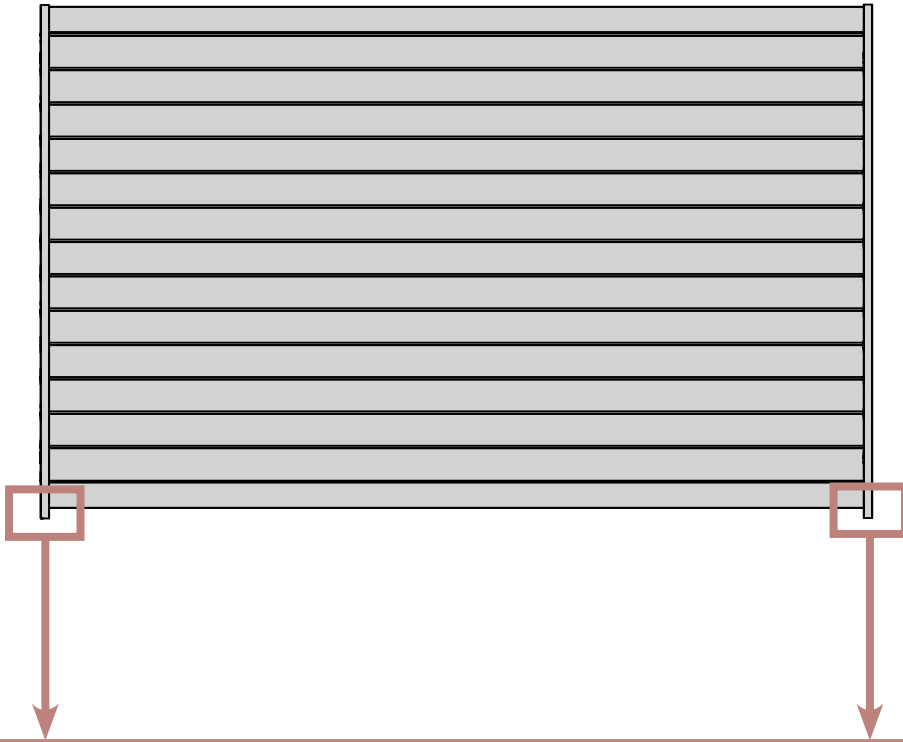

NT39

NT77

8

A

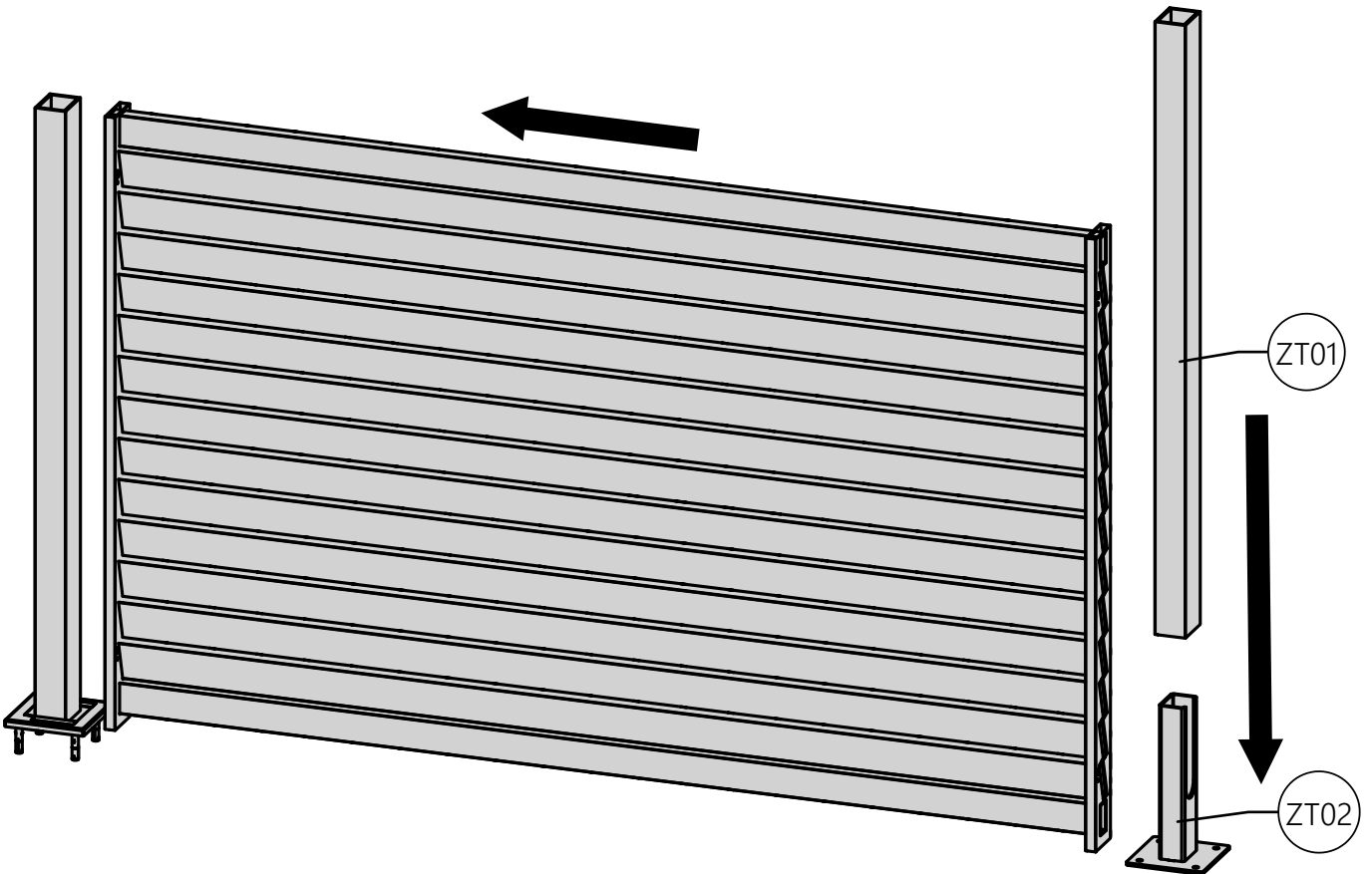
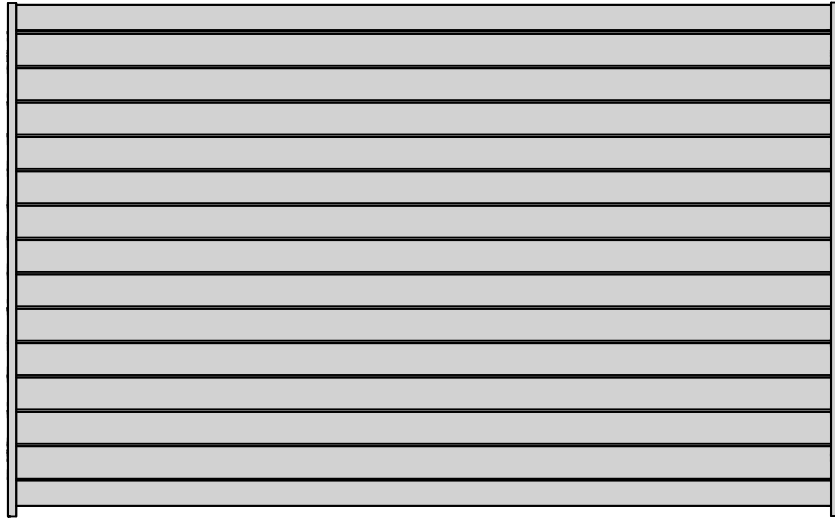

9

A

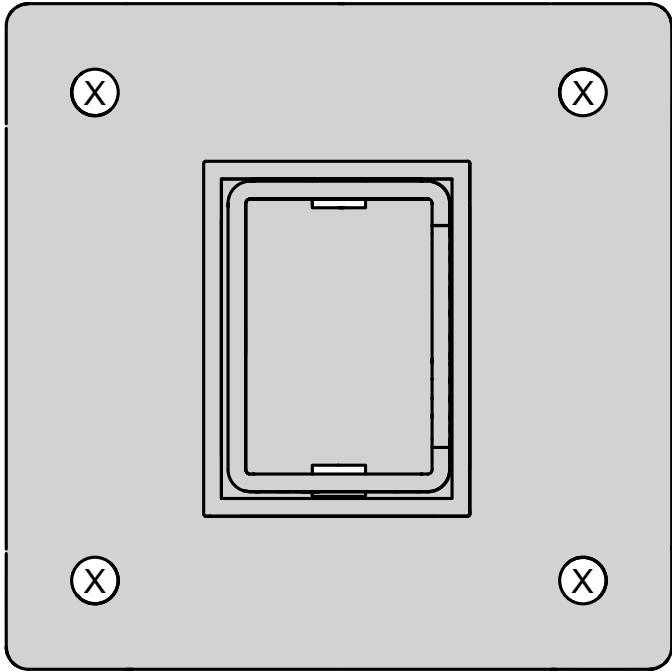
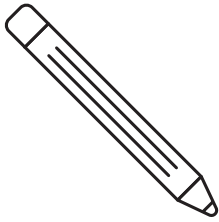

10

A

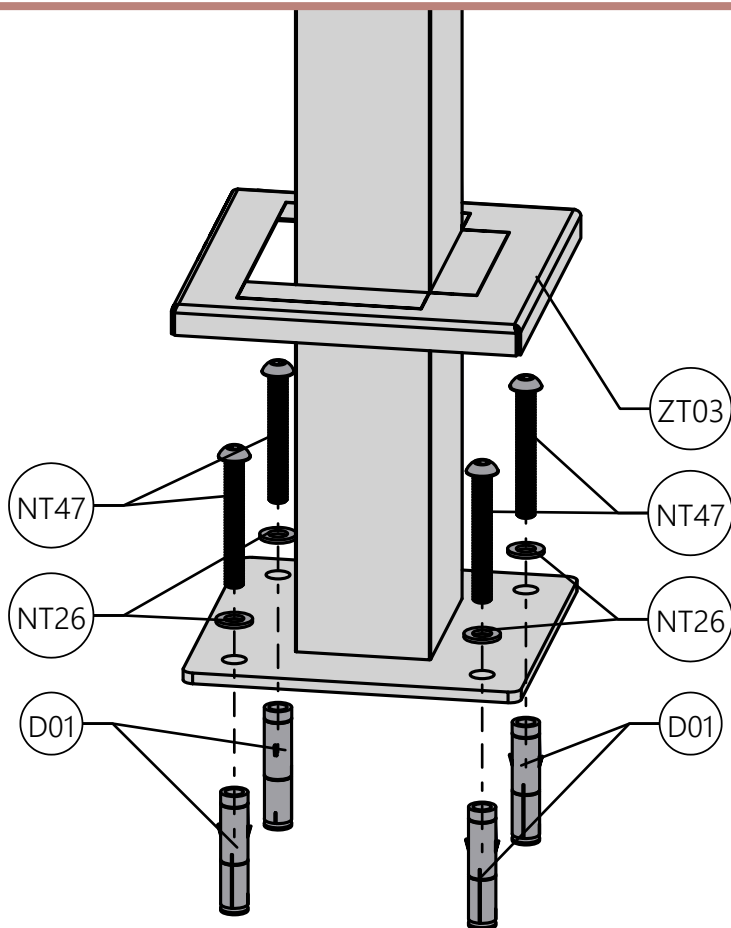
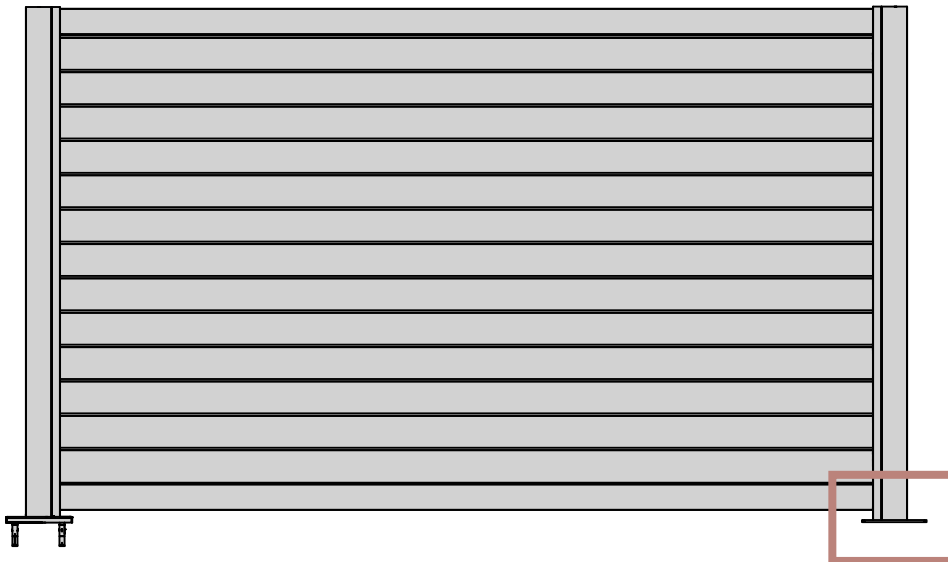
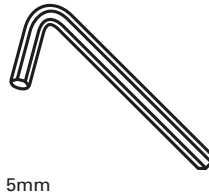
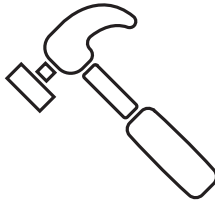
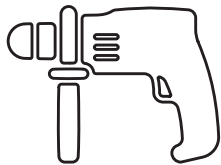
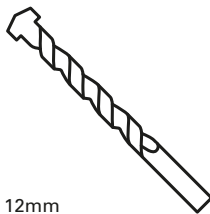

11

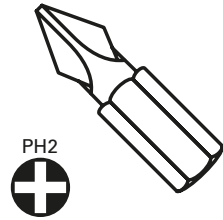

PH2
+

A

B

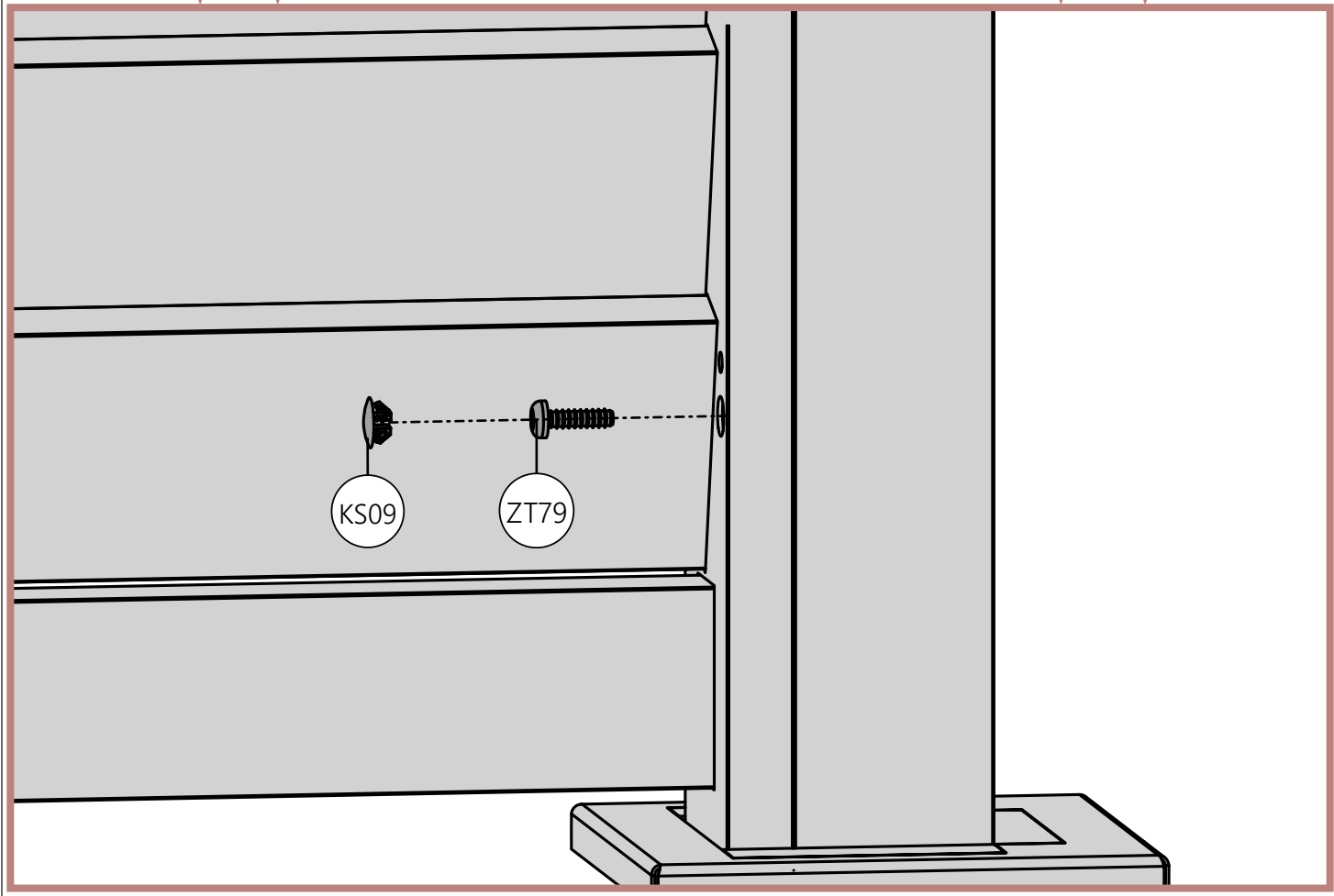
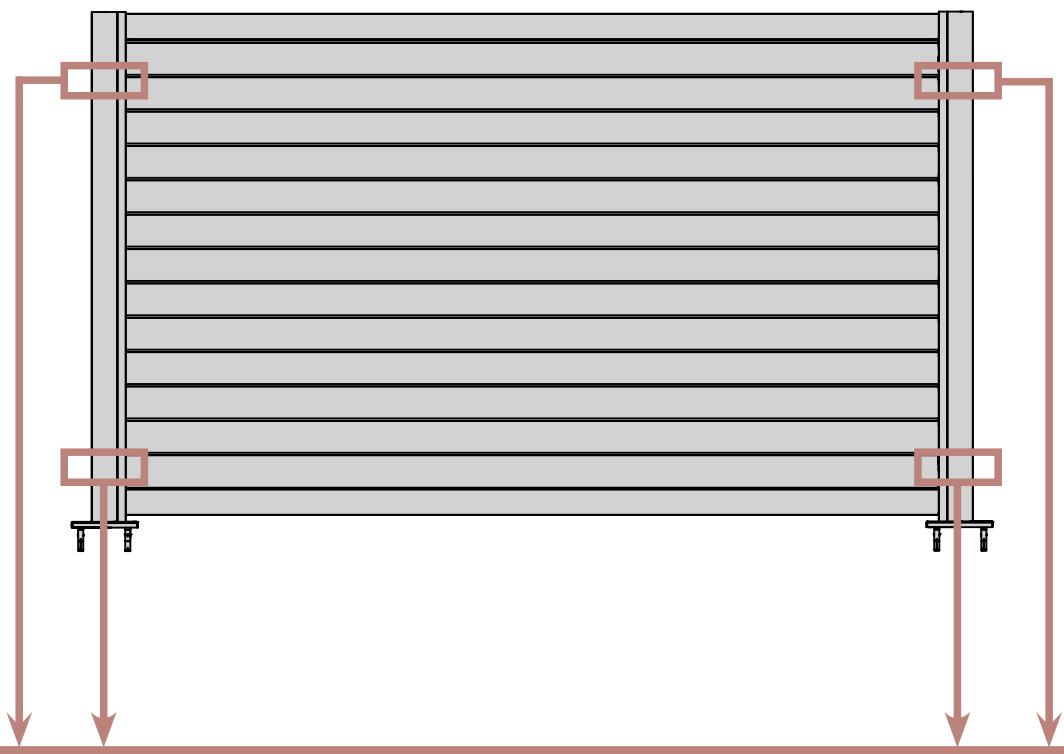

12

C

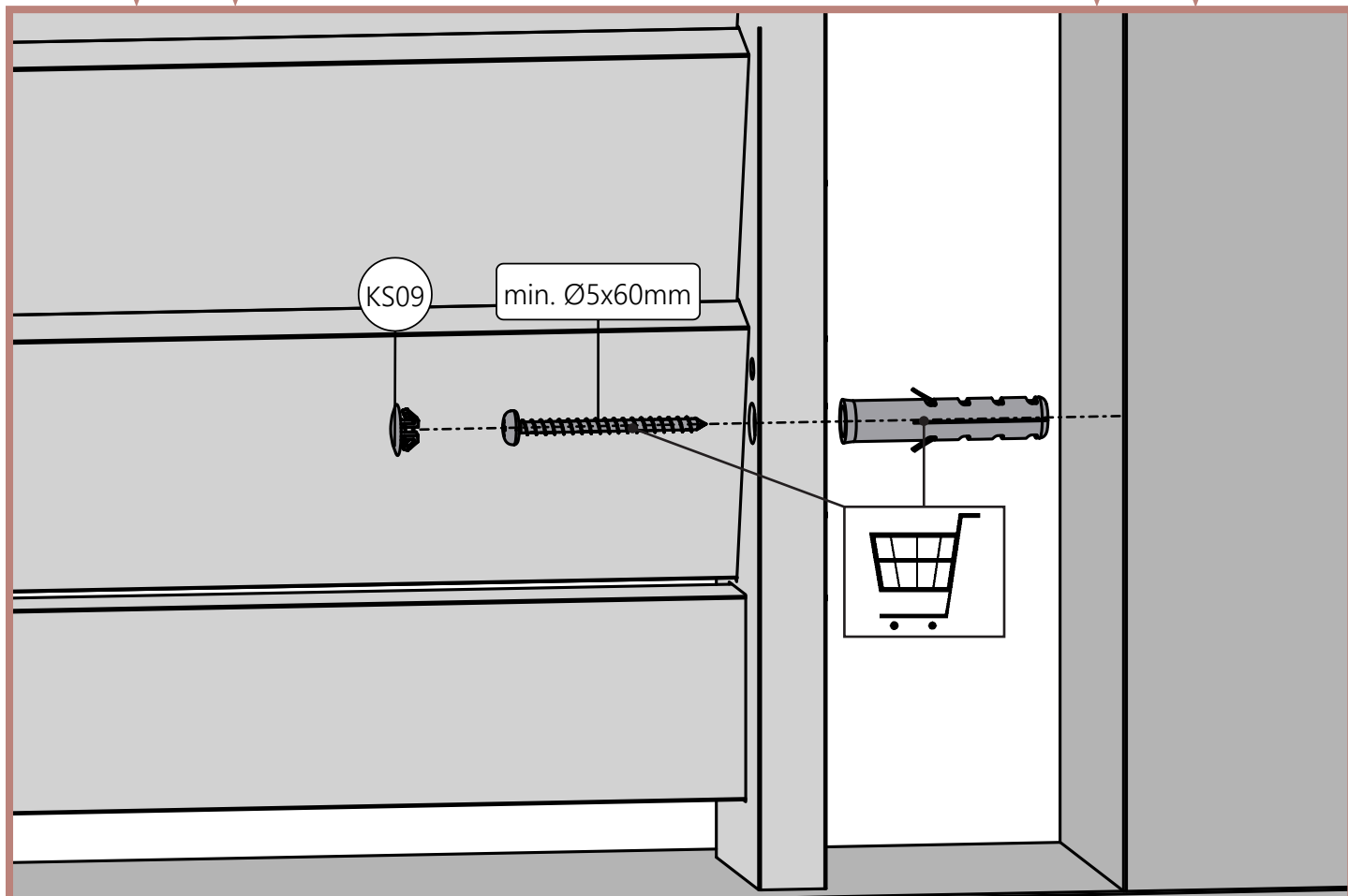
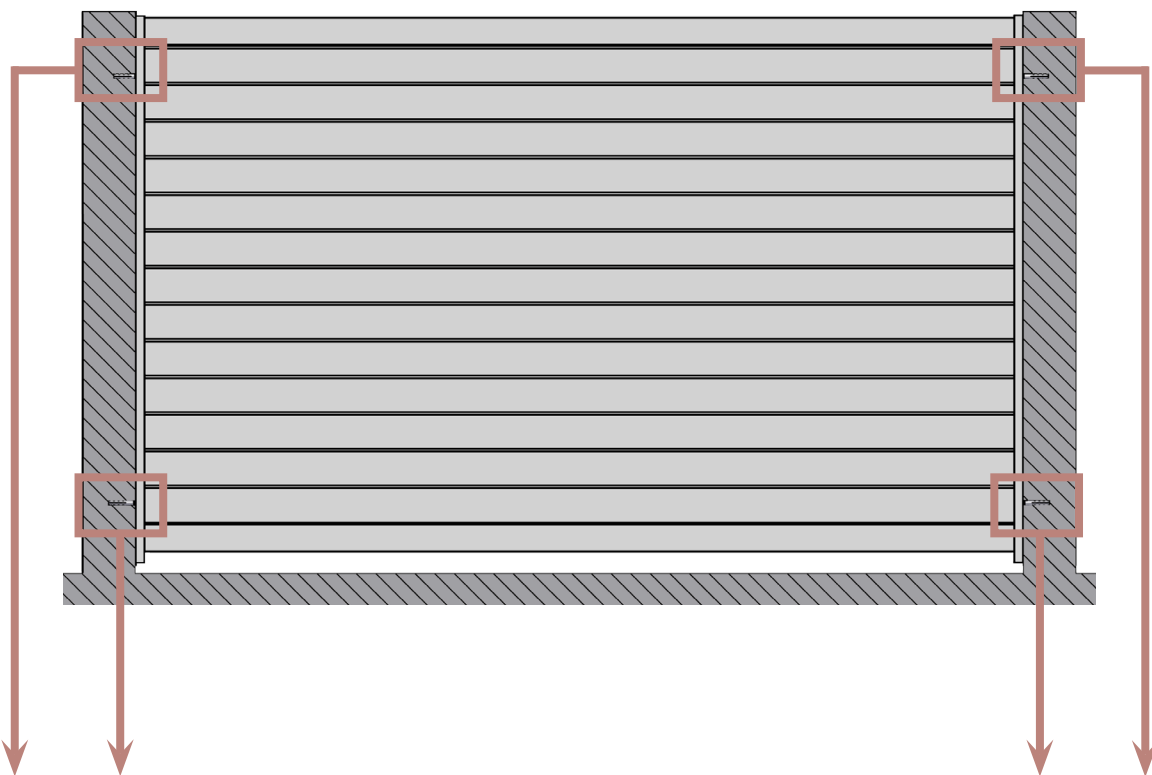
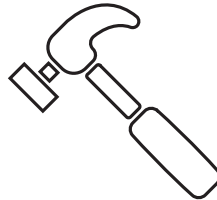
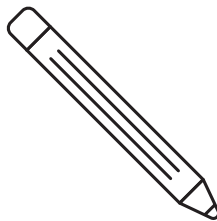
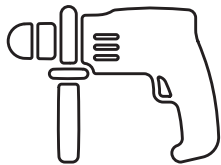
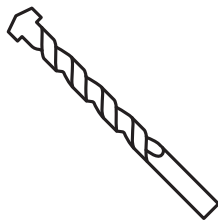

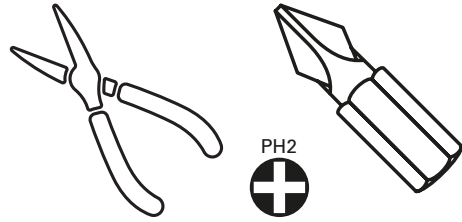

A

B

