

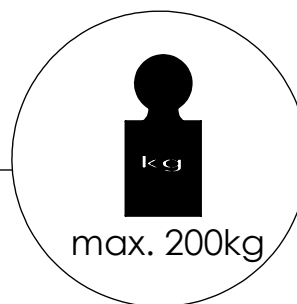

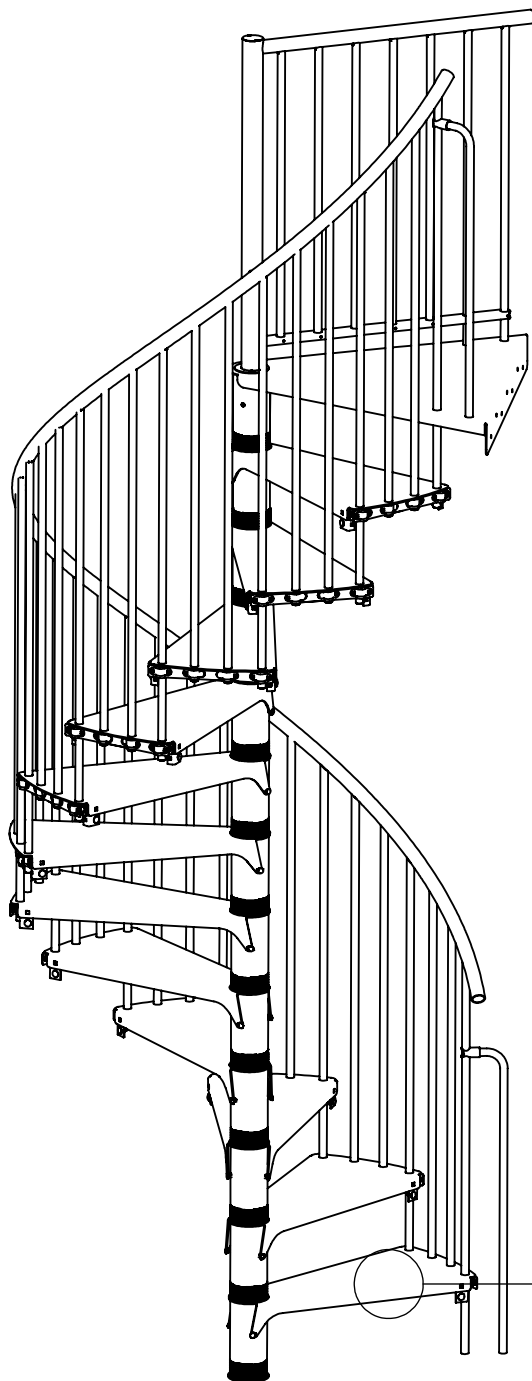

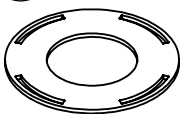

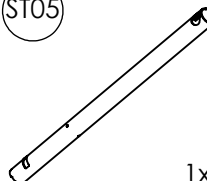

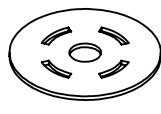
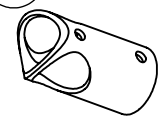
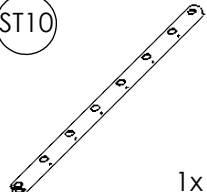
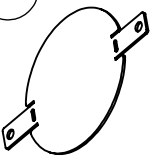
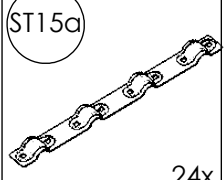

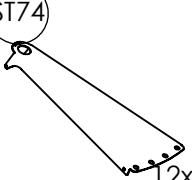
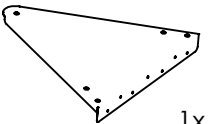
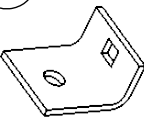
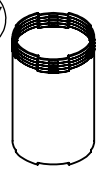

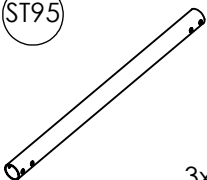
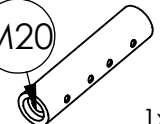
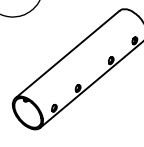
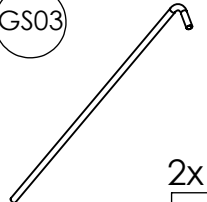
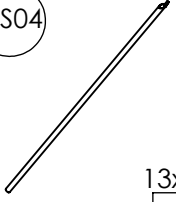
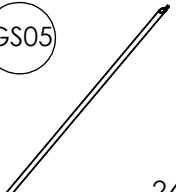
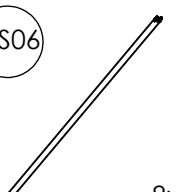
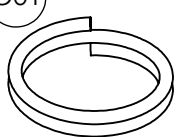
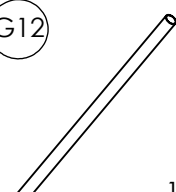

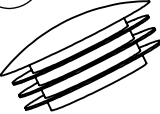

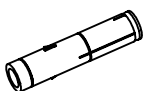

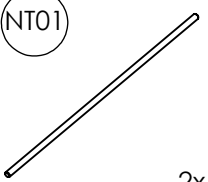
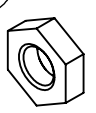
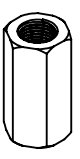

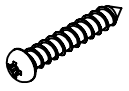
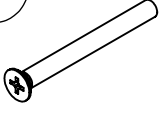
	9	10	11	12	13
H min	1710mm	1900mm	2090mm	2280mm	2470mm
H max	2115mm	2350mm	2585mm	2820mm	3055mm

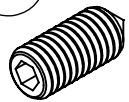

## Rondo Zink Smart/Color 180 13111\_02

<p>ST94</p>  <p>13x</p> <p>Ø 115 x 3 mm</p>	<p>ST05</p>  <p>1x</p> <p>Ø 60 x 1000x4 mm</p>	<p>ST06</p>  <p>1x</p> <p>Ø 100 x 3 mm</p>	<p>ST07</p>  <p>2x</p> <p>Ø 28x2x50 mm</p>	<p>ST10</p>  <p>1x</p>	<p>ST12</p>  <p>1x</p> <p>Ø 60 mm</p>
<p>ST15a</p>  <p>24x</p>	<p>ST15b</p>  <p>4x</p>	<p>ST74</p>  <p>12x</p>	<p>ST75</p>  <p>1x</p>	<p>ST76</p>  <p>24x</p>	<p>ST77</p>  <p>13x</p> <p>Ø 108x220 mm</p>
<p>ST93</p>  <p>1x</p>	<p>ST95</p>  <p>3x</p> <p>Ø 60,2 x 980 mm</p>	<p>ST96</p>  <p>1x</p> <p>M20</p>	<p>ST97</p>  <p>1x</p>	<p>GS03</p>  <p>2x</p> <p>Ø 22x1x913+170mm</p>	<p>GS04</p>  <p>13x</p> <p>Ø 22x2x1275 mm</p>
<p>GS05</p>  <p>24x</p> <p>Ø 22x1x1175 mm</p>	<p>GS06</p>  <p>8x</p> <p>Ø 22x2x1030 mm</p>	<p>G01</p>  <p>1x</p> <p>Ø 40x3x6000mm</p>	<p>G12</p>  <p>1x</p> <p>Ø 40x3x1100 mm</p>	<p>KS01</p>  <p>40x</p> <p>Ø 22 mm</p>	<p>KS02</p>  <p>3x</p> <p>Ø 40 mm</p>
<p>KS06</p>  <p>2x</p>	<p>D01</p>  <p>9x</p> <p>Ø 12 mm</p>	<p>D03</p>  <p>2x</p> <p>Ø 6 mm</p>	<p>NT01</p>  <p>2x</p> <p>M20 x 1000 mm</p>	<p>NT02</p>  <p>1x</p> <p>M20 DIN-EN 24035</p>	<p>NT03</p>  <p>1x</p> <p>M20 DIN 6334</p>
<p>NT07</p>  <p>22x</p> <p>Ø 4,2 x 19 mm</p>	<p>NT08</p>  <p>2x</p> <p>Ø 4 x 50 mm</p>	<p>NT11</p>  <p>96x</p> <p>Ø 4x25mm</p>	<p>NT13</p>  <p>104x</p> <p>M6 x 16 mm DIN 603</p>	<p>NT20</p>  <p>5x</p> <p>M8x70 mm</p>	<p>NT24</p>  <p>48x</p> <p>M8</p>
<p>NT26</p>  <p>29x</p> <p>M8 DIN 125</p>	<p>NT39</p>  <p>2x</p> <p>M5 DIN 9021</p>	<p>NT40</p>  <p>3x</p> <p>M8x25mm</p>	<p>NT45</p>  <p>104x</p> <p>M6 DIN 934</p>	<p>NT46</p>  <p>48x</p> <p>M8 x 30 mm DIN 603</p>	<p>NT54</p>  <p>14x</p> <p>M8x55mm DIN6912</p>

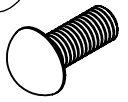
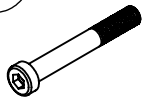
Rondo Zink Smart/Color 180 13111\_02

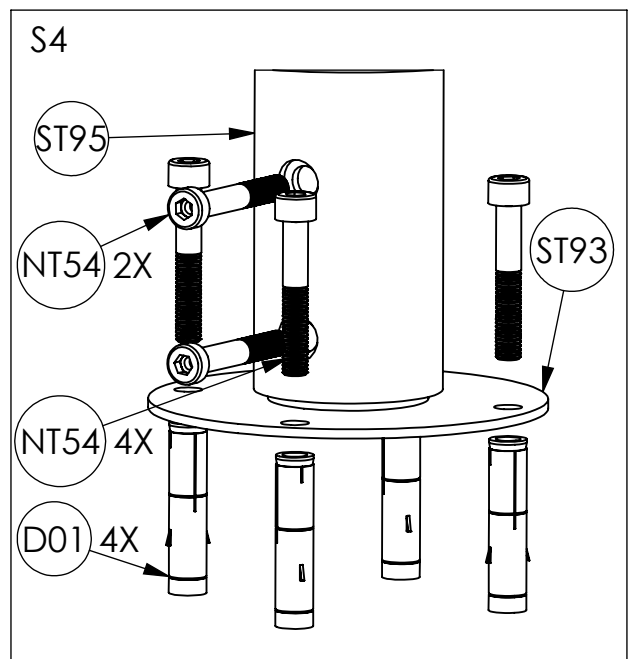
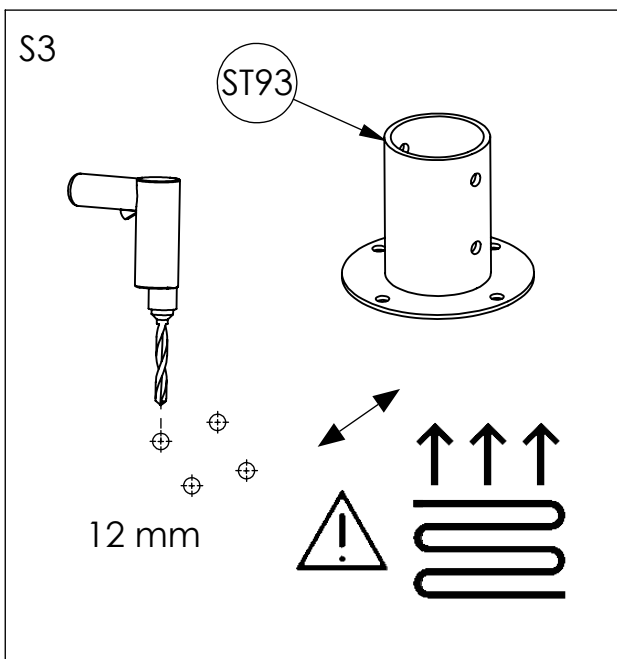
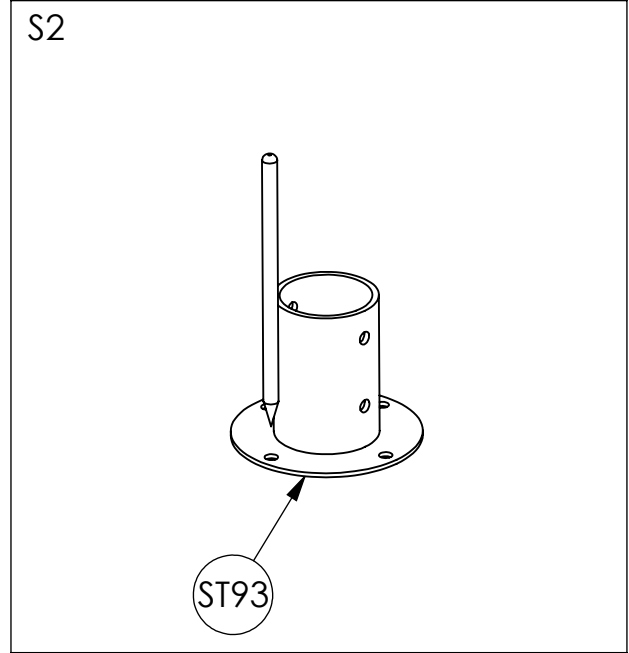
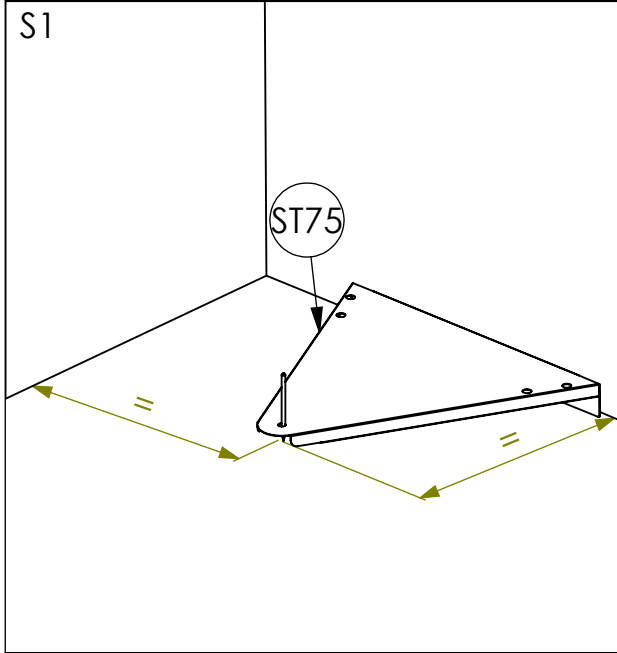
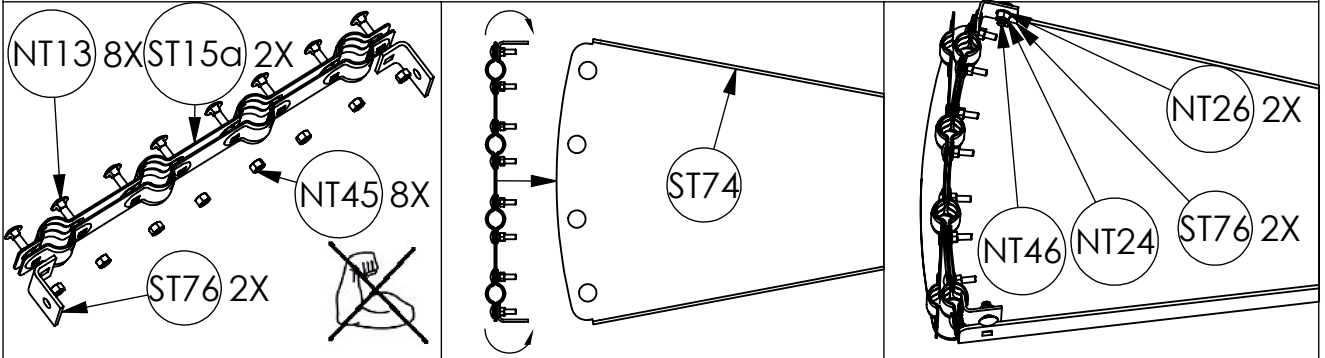

3

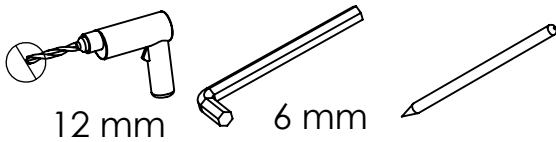

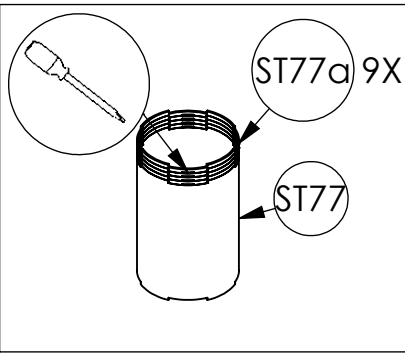
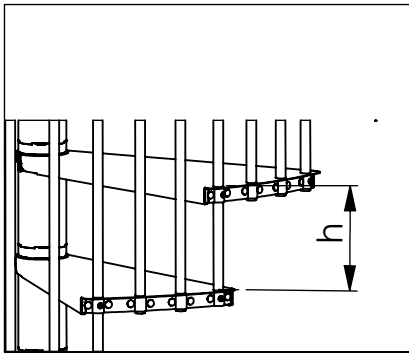

h	ST77a
190 mm	0x
195 mm	1x
200 mm	2x
205 mm	3x
210 mm	4x
215 mm	5x
220 mm	6x
225 mm	7x
230 mm	8x
235 mm	9x

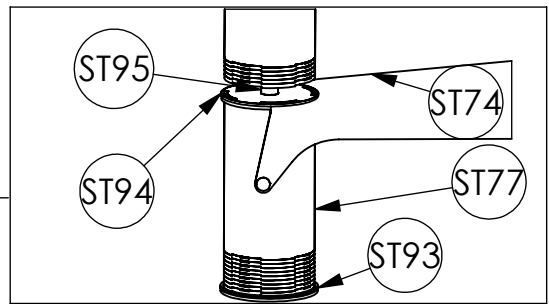
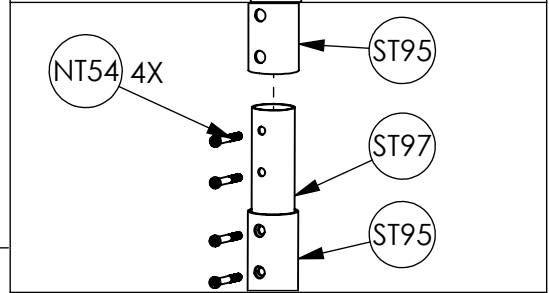
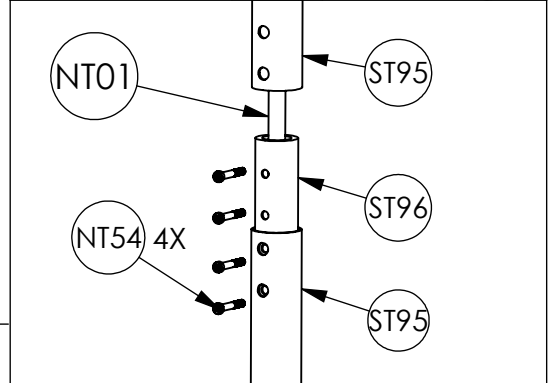
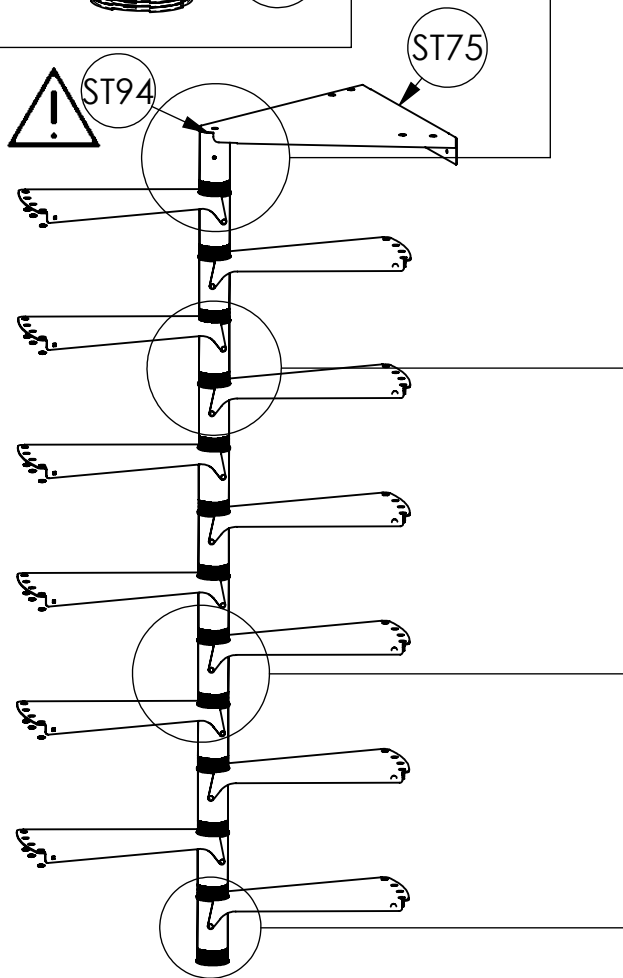
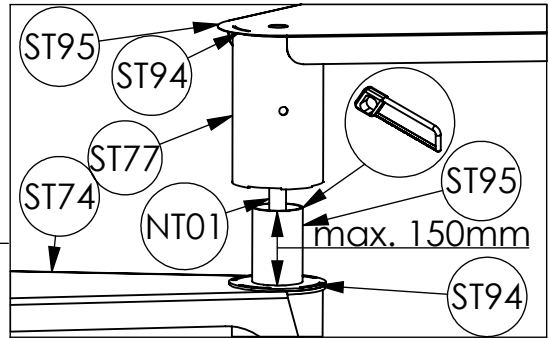
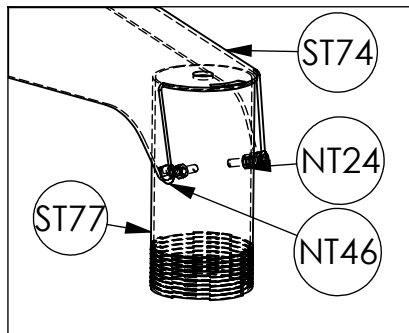

4

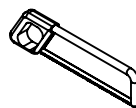
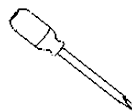
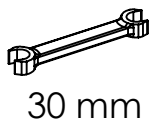

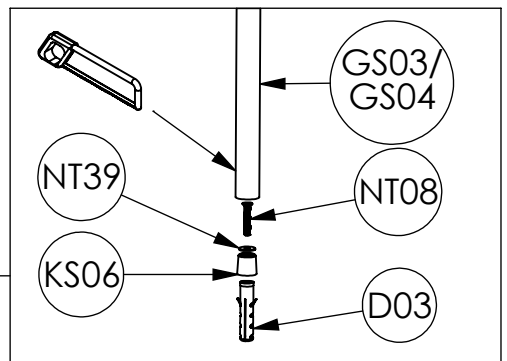
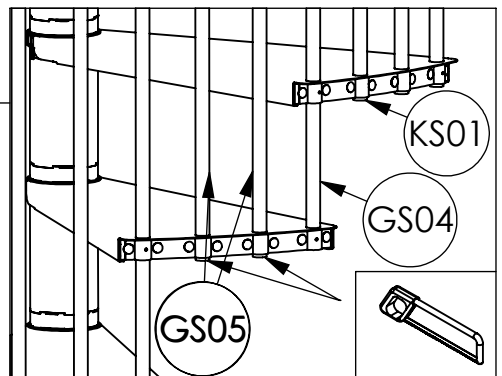
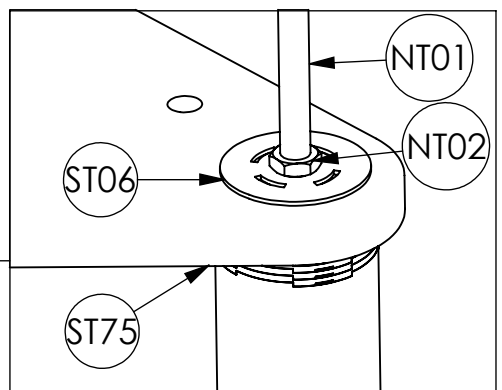
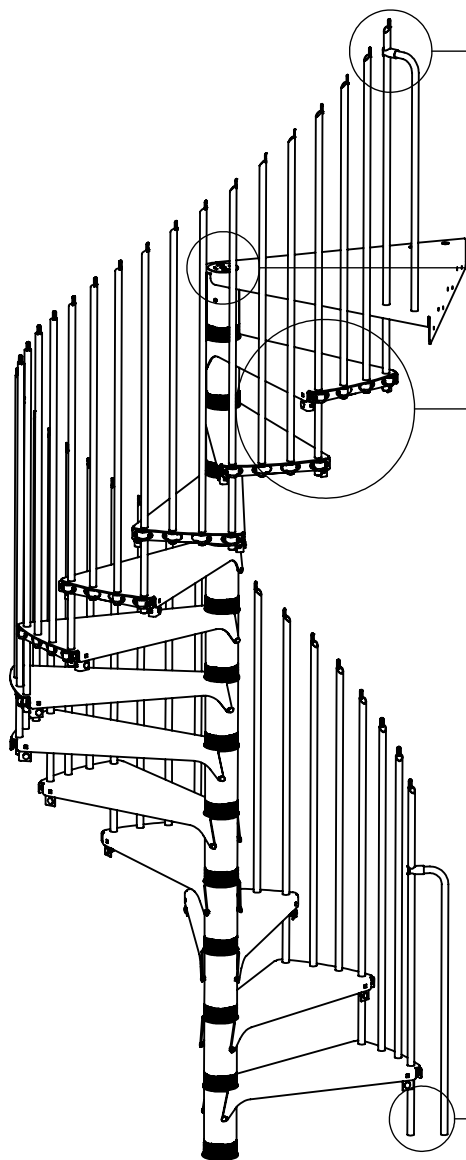
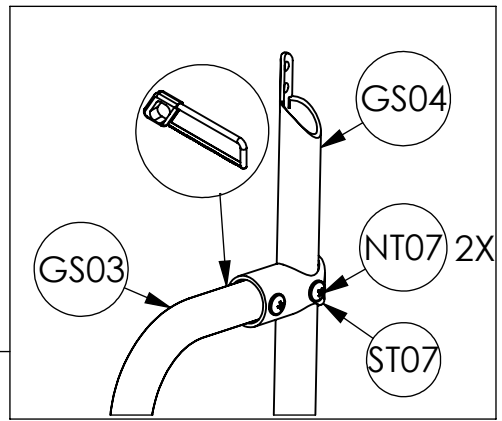
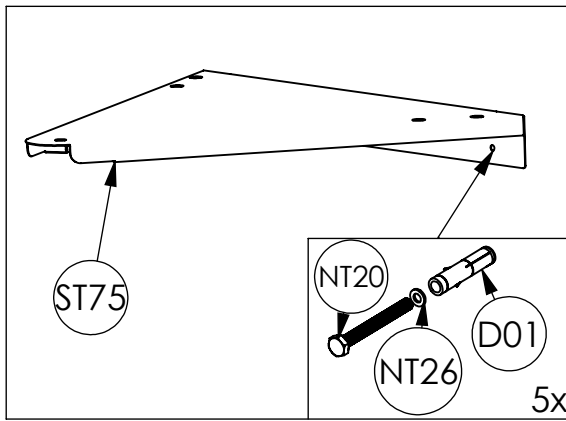

5

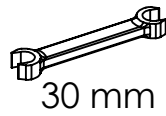
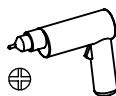
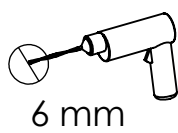
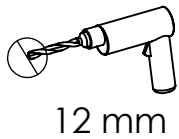

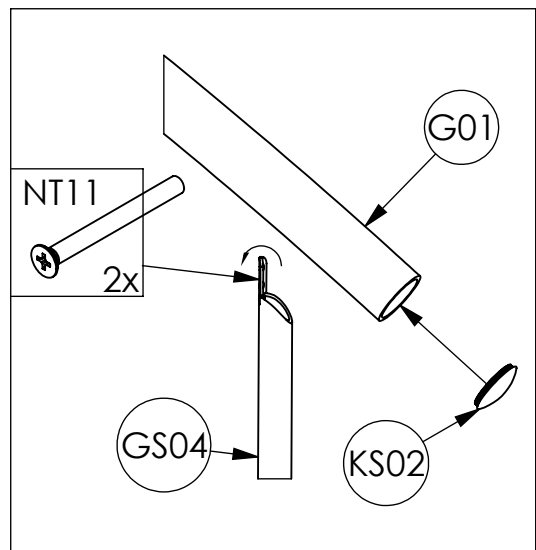
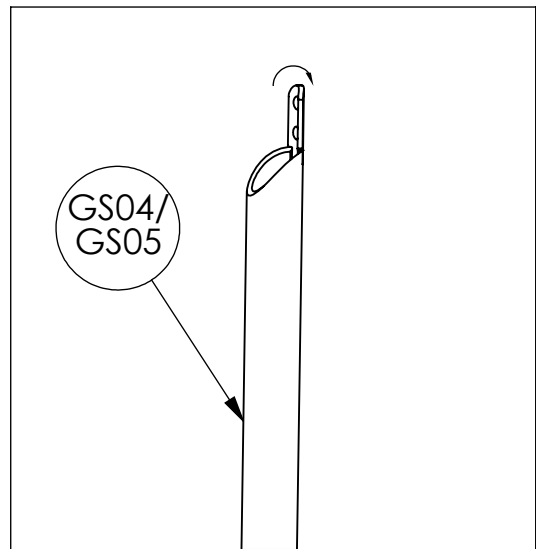
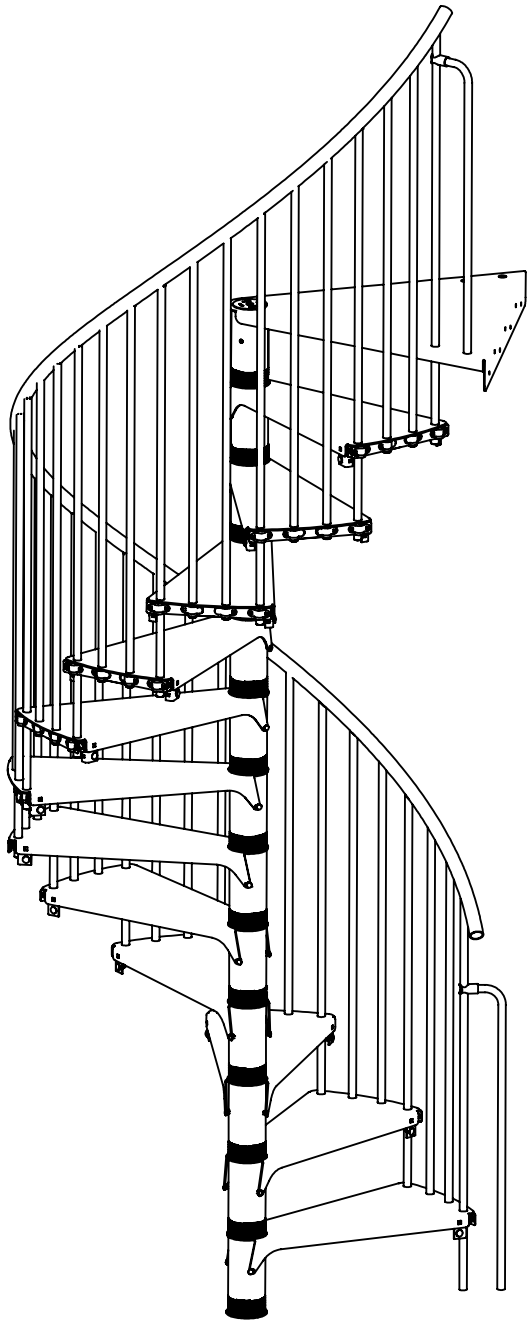

6

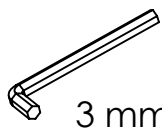

3 mm

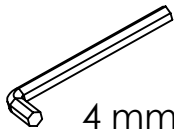

4 mm

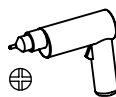

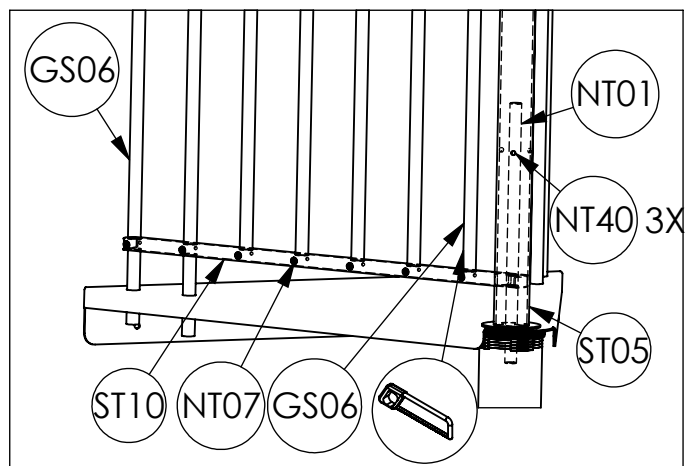
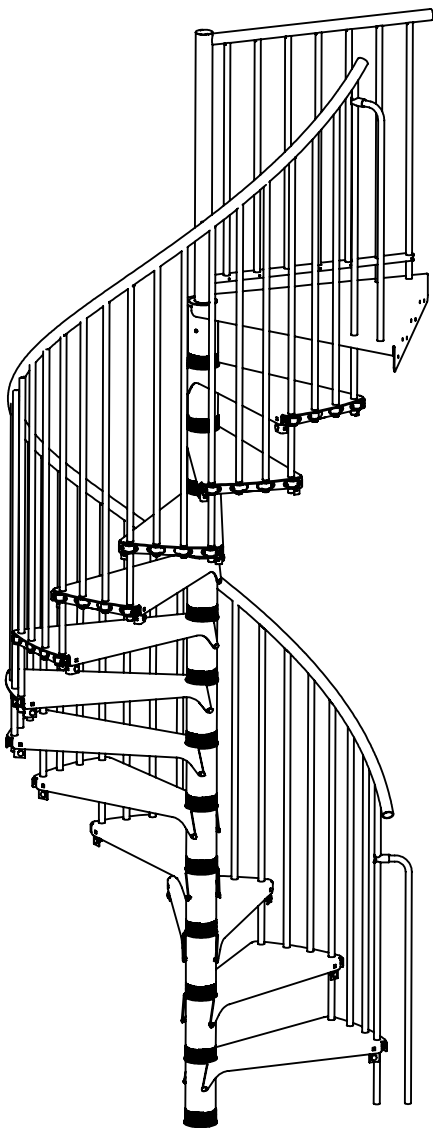
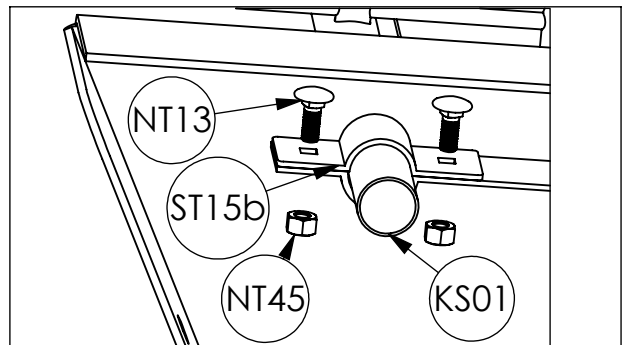
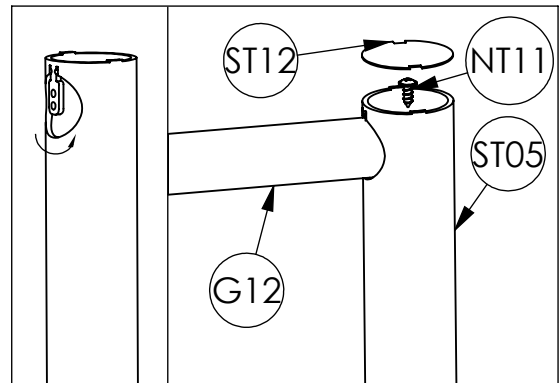
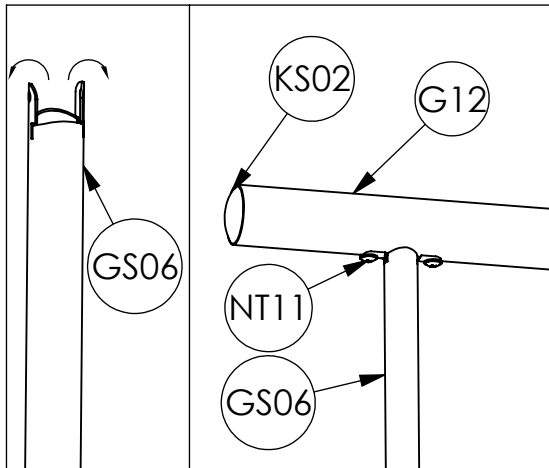

7

