

# PRISMA 120

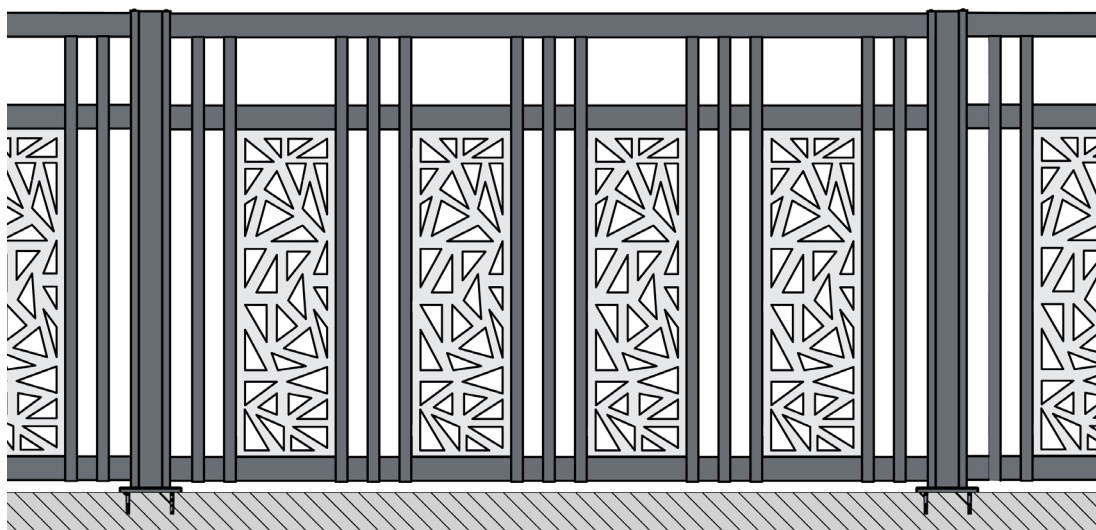

A



B

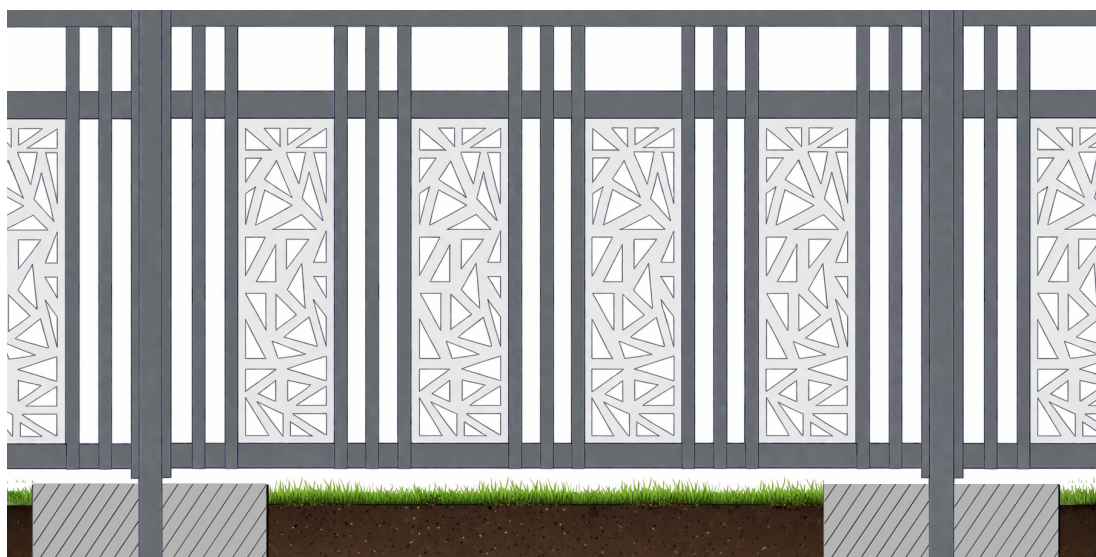

C

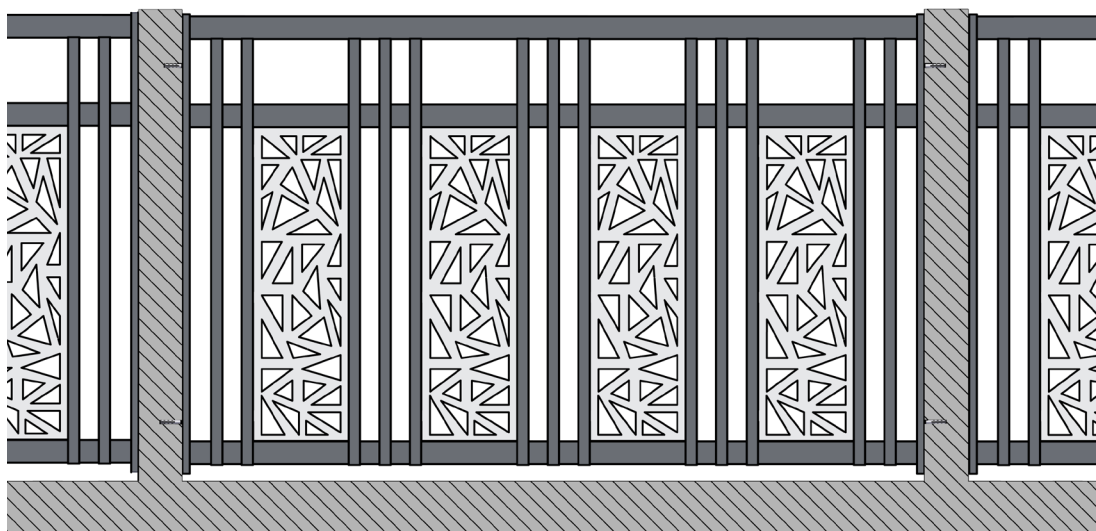

# PRISMA 120

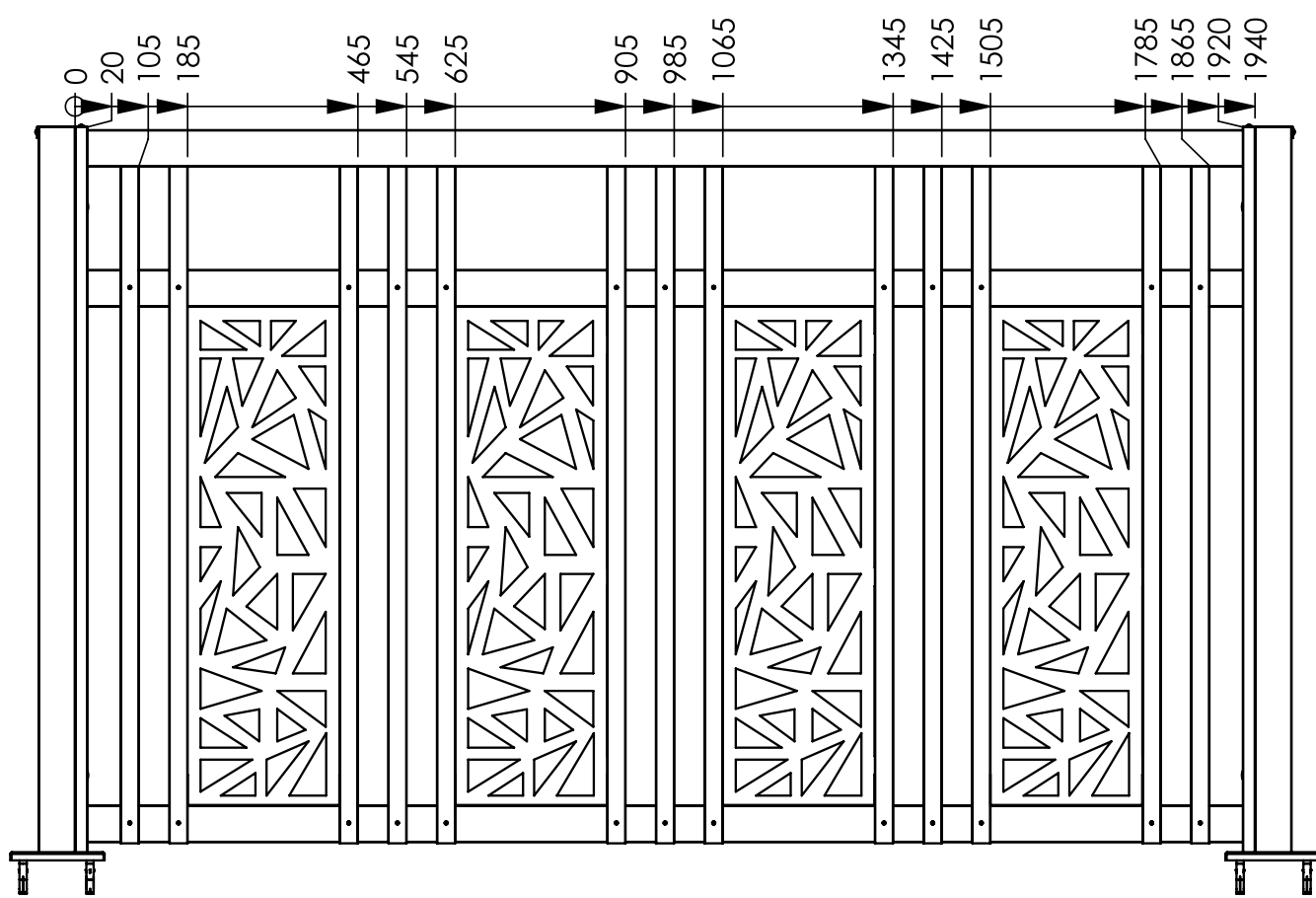
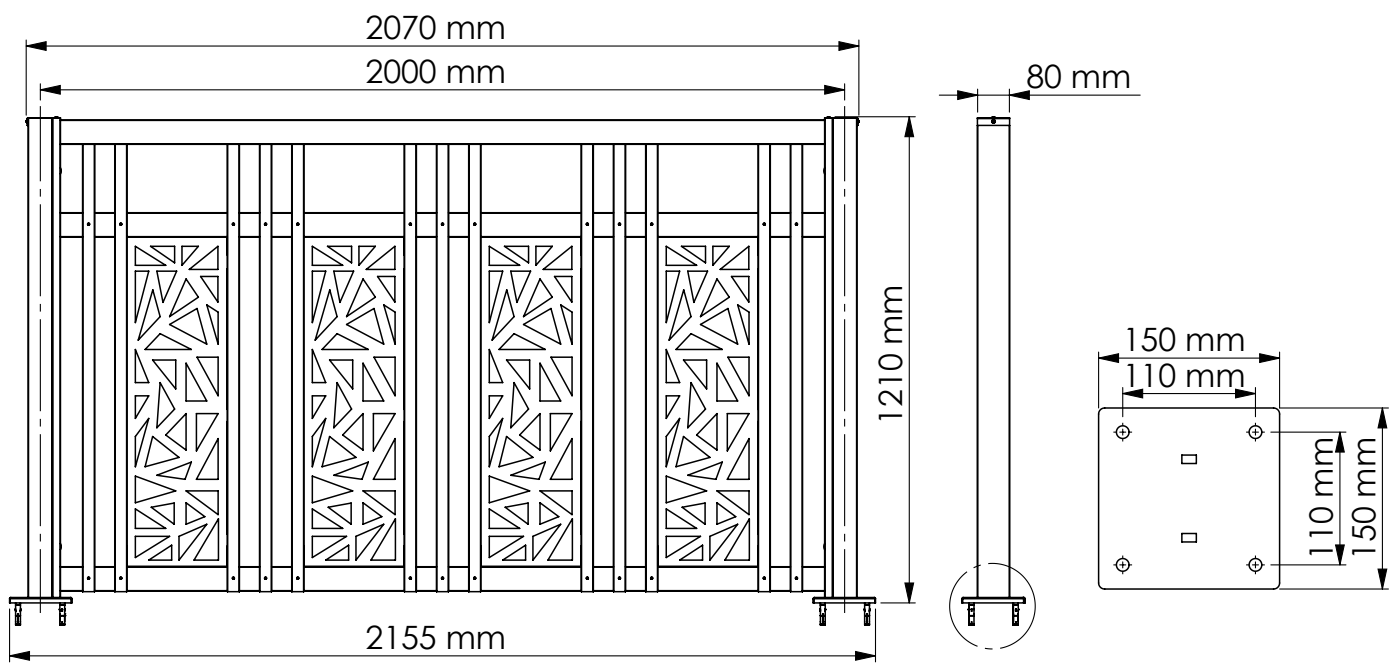

# PRISMA 120



8x

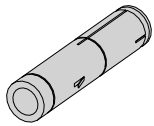

D01 M8x55 mm

4x

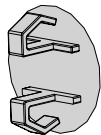

KS09 Ø13 mm

8x

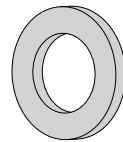

NT26 M8 DIN125A

12x

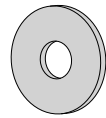

NT39 M5 DIN 9021

8x

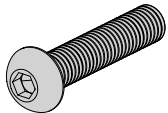

NT47 M8x60 mm ISO7380-1

6x

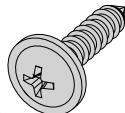

NT77 Ø3,5x16 mm

26x

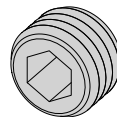

NT78 M6x6 mm

4x

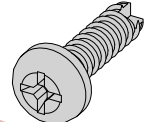

NT79 Ø5,5x22 mm

2x

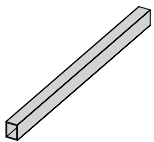

ZT01 80x60x1200 mm

2x

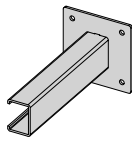

ZT02

2x

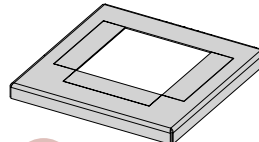

ZT03

2x

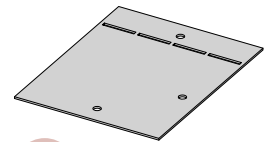

ZT04

2x

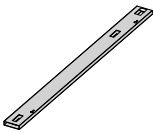

ZT06 80x20x1200 mm

1x



ZT07 60x30x1940 mm

2x



ZT08 60x20x1940 mm

13x



ZT09 30x25x1113,5 mm

4x



ZT10

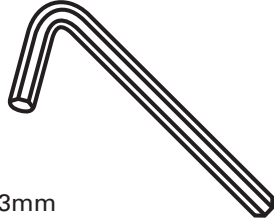
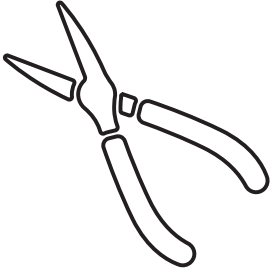

3mm  
5mm

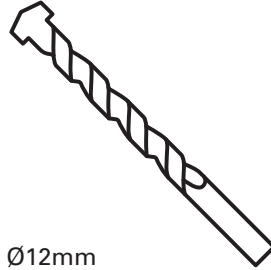

Ø12mm

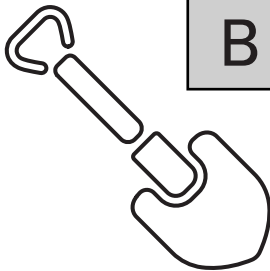
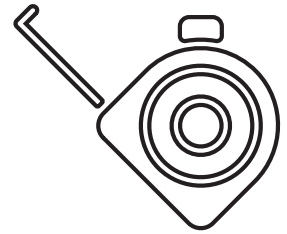
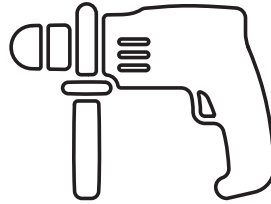
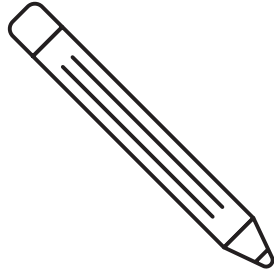
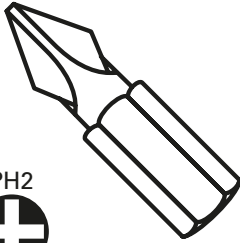
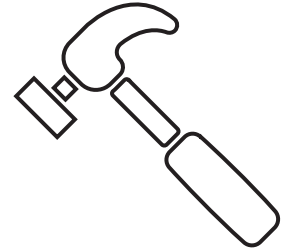

B

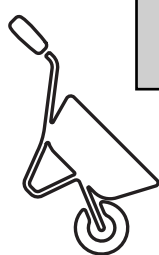

B

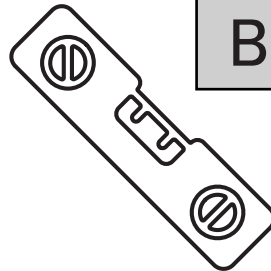

B

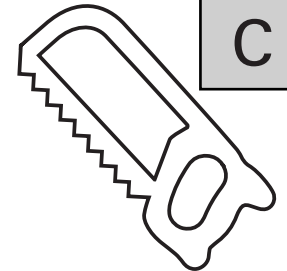

C

4x

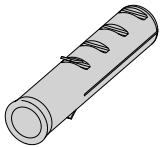

C

4x



C

min. Ø5x60 mm

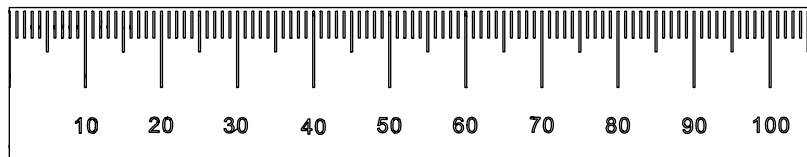

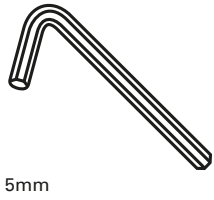
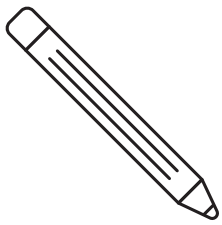

5mm

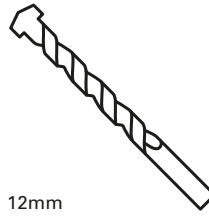
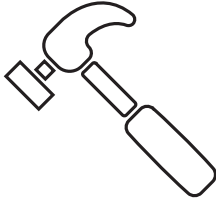

12mm

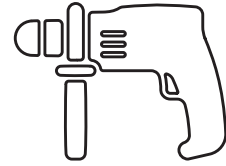

1

A

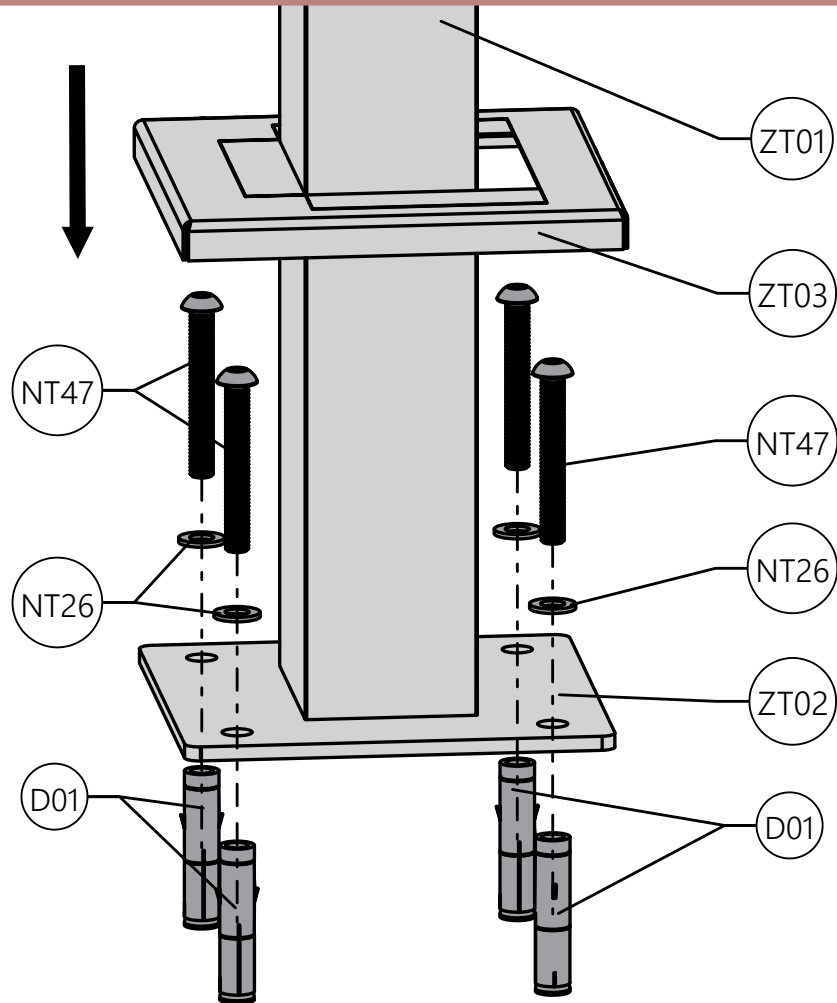
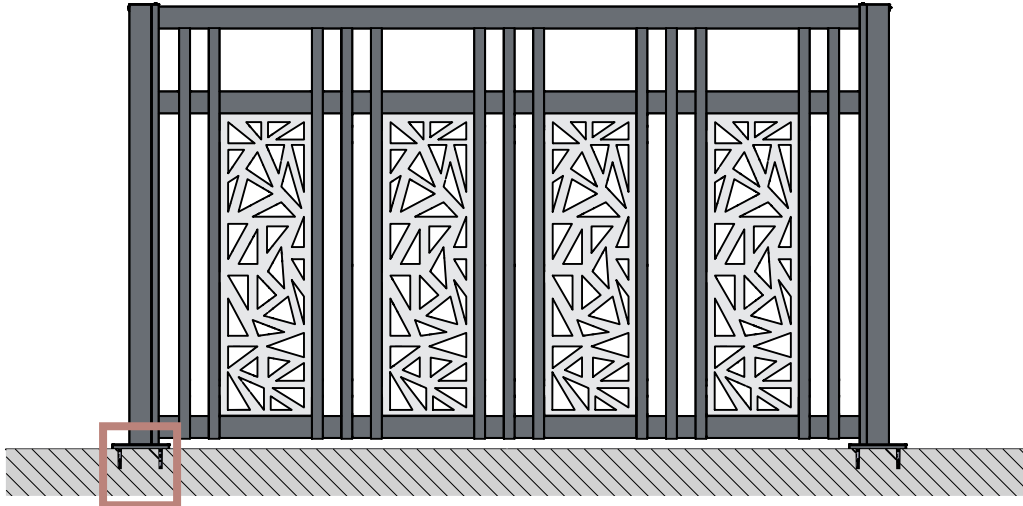

2

B

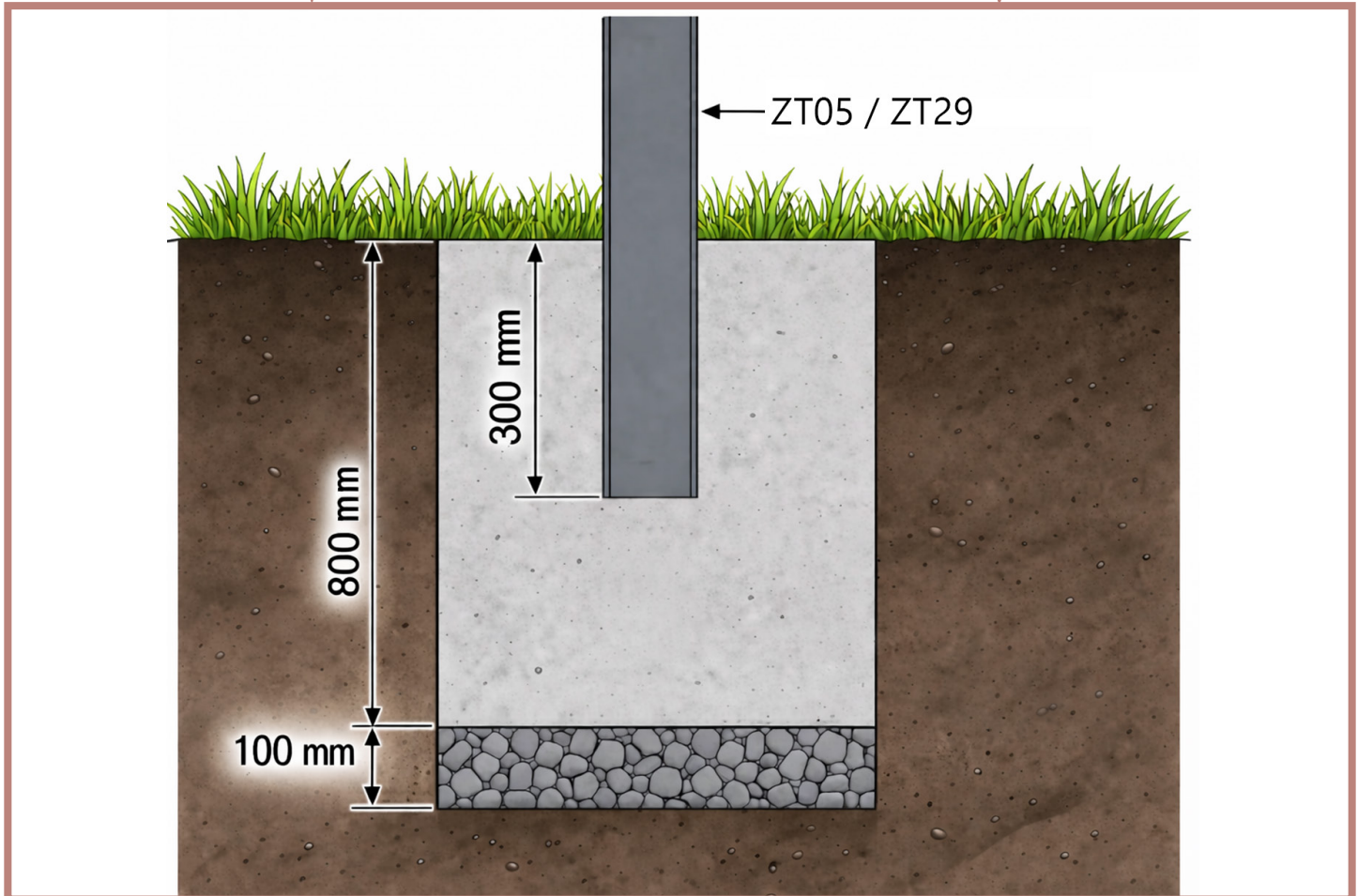
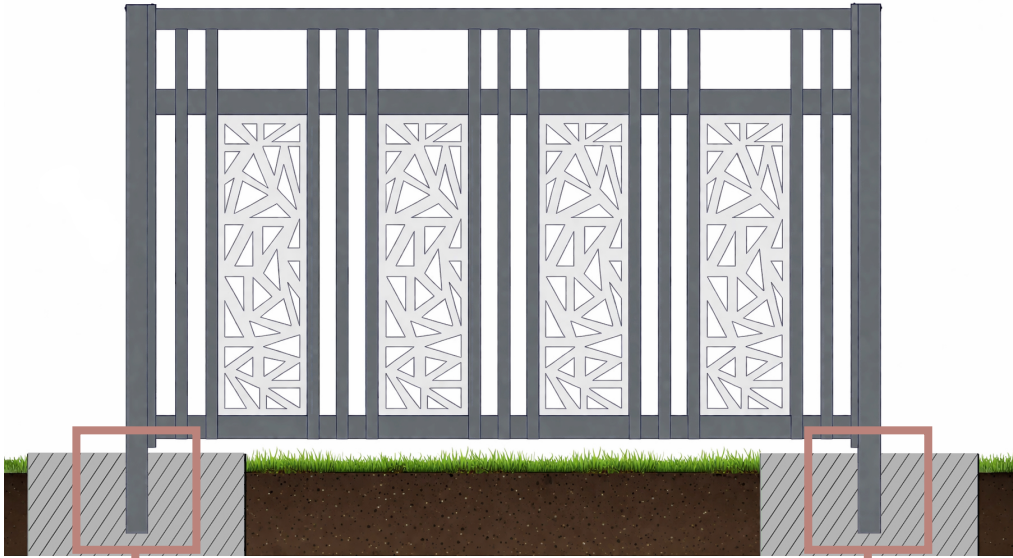
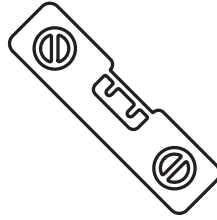
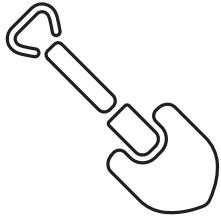

3

C

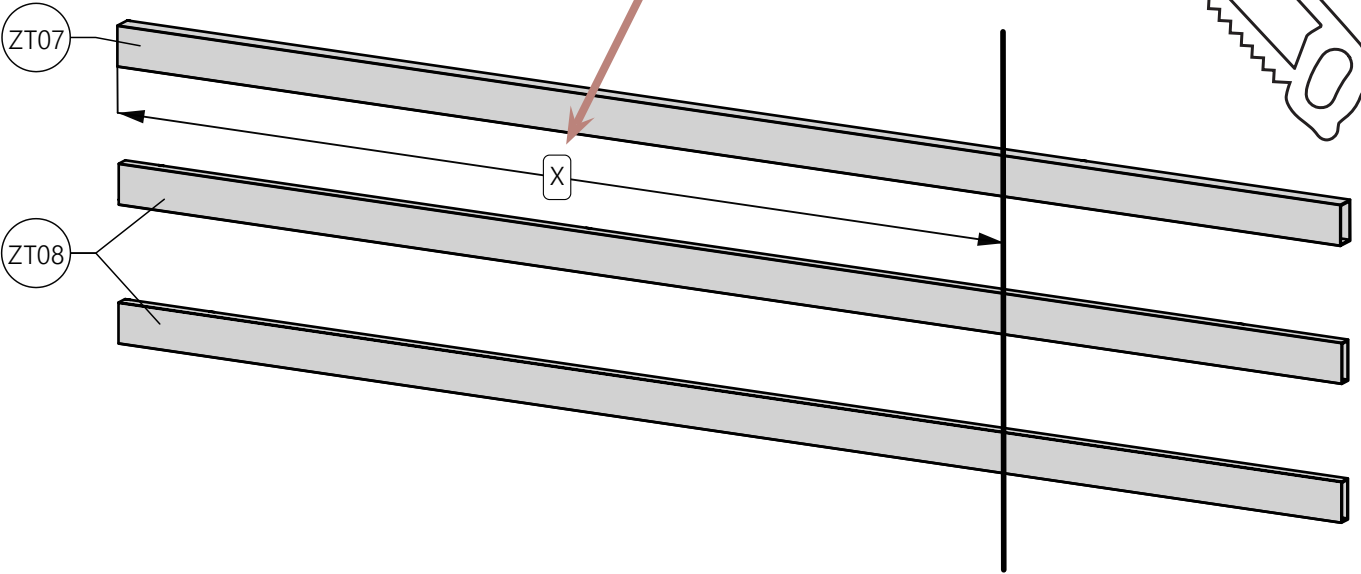
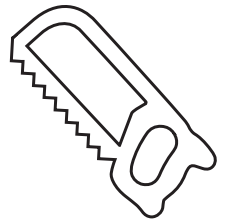
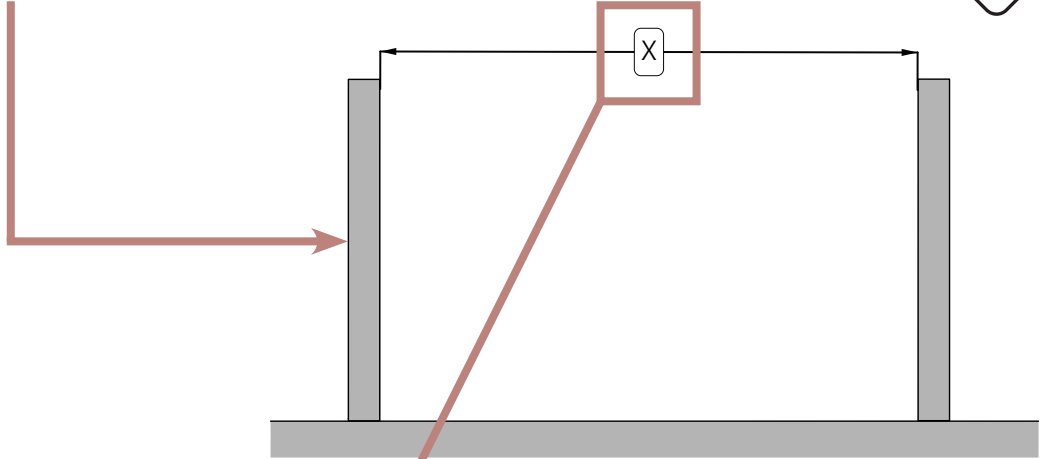
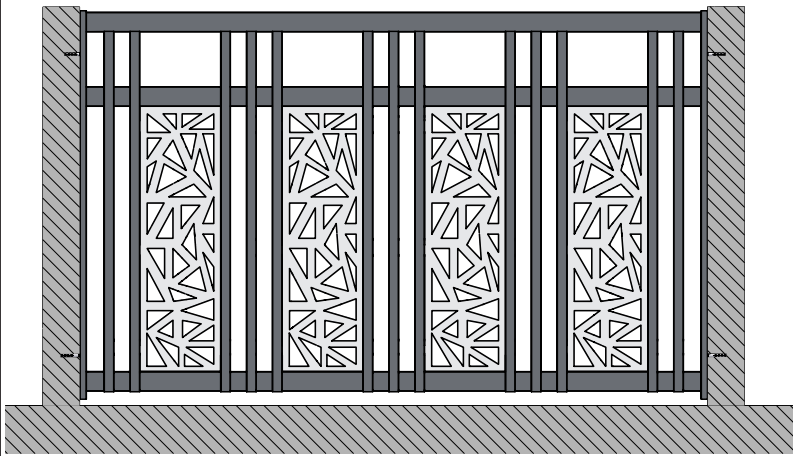
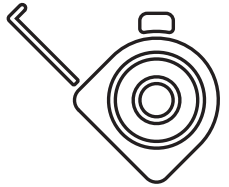

4

A

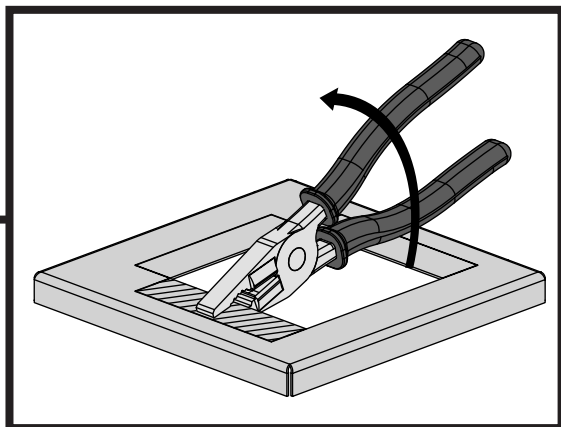
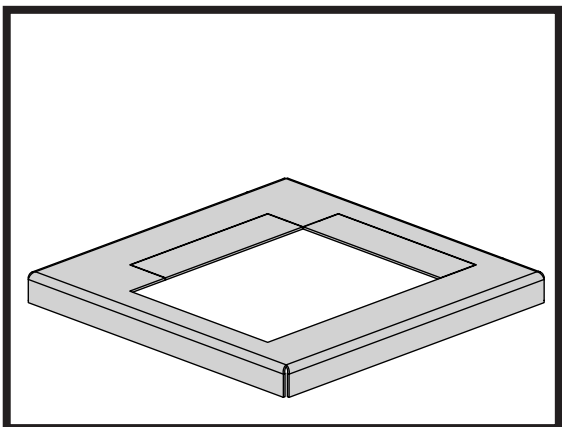
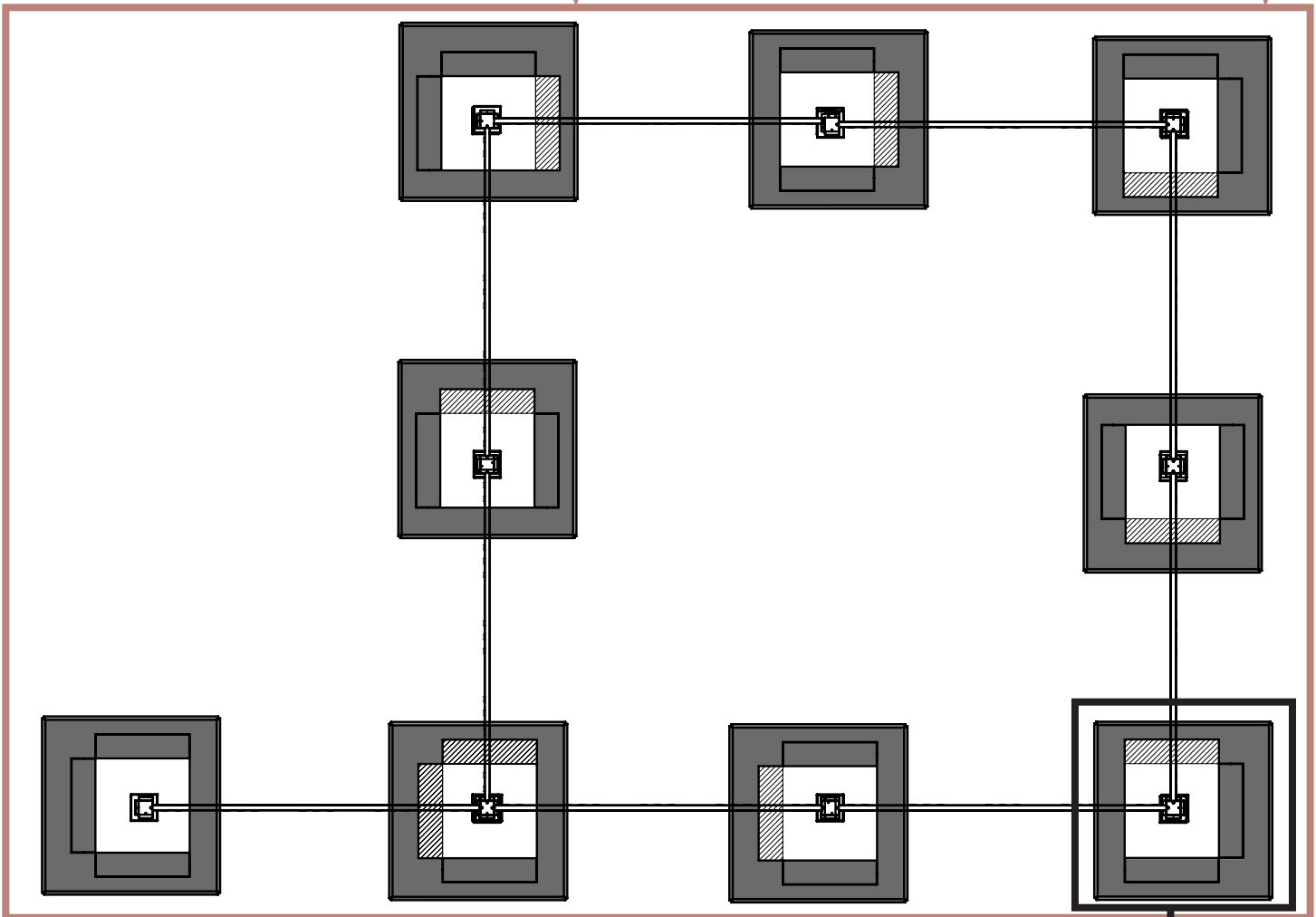

5

A

B

C

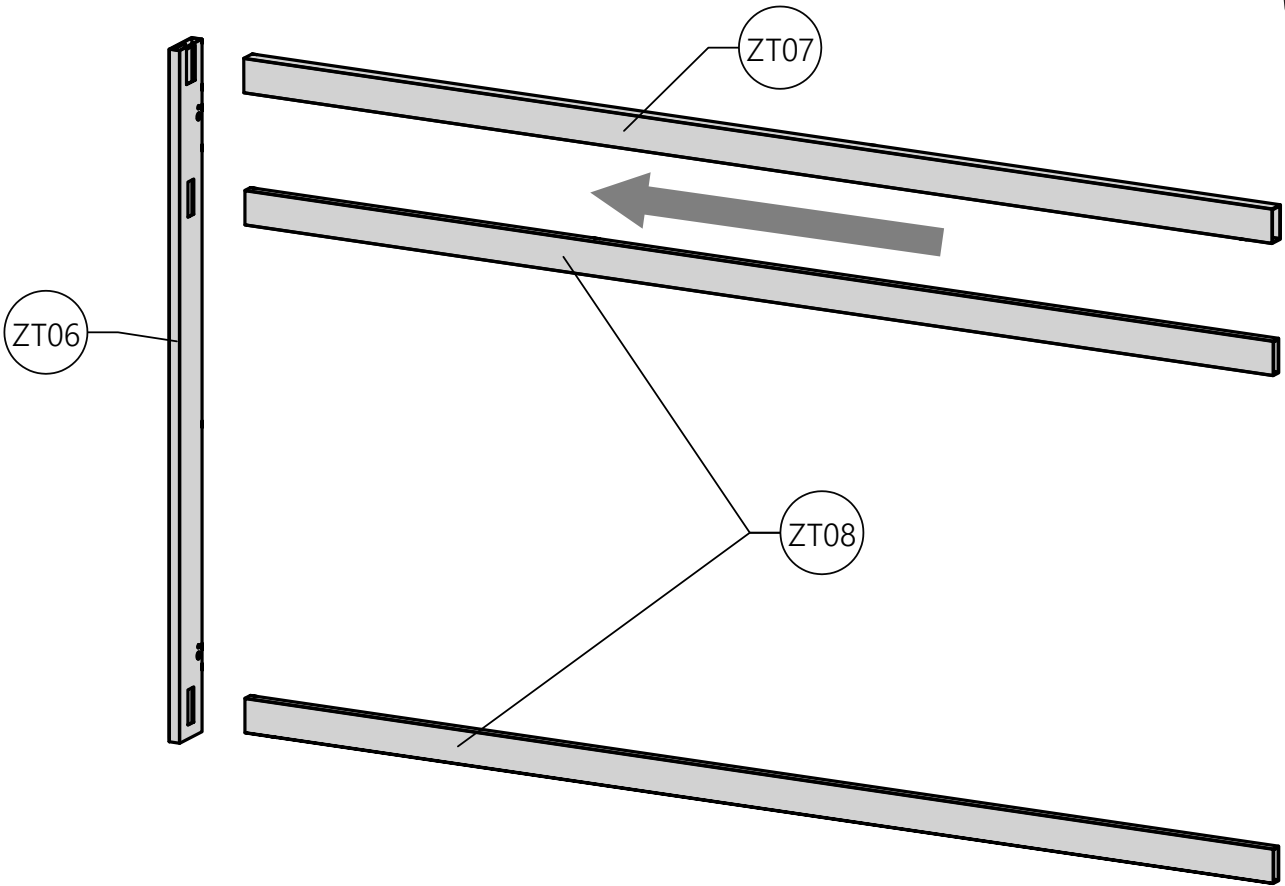

A

B

C

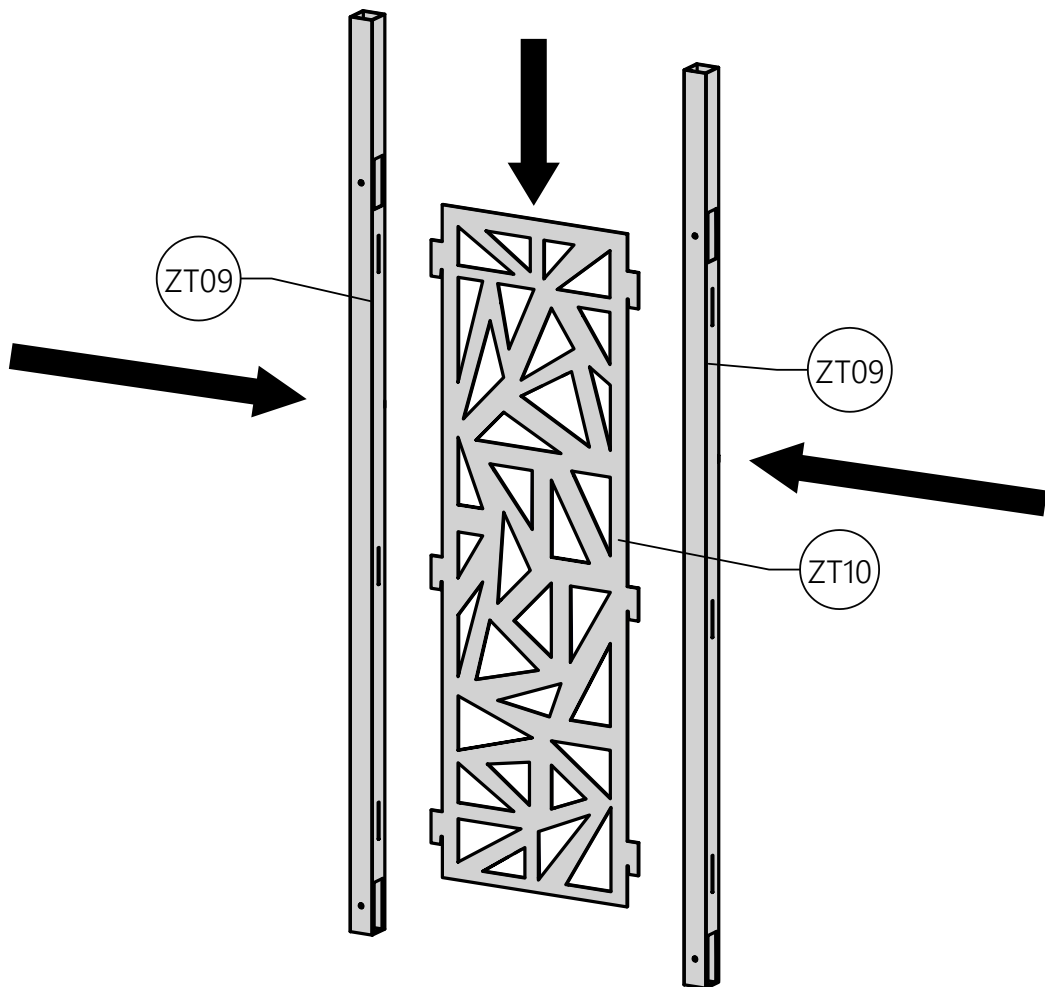

6

7

A

B

C

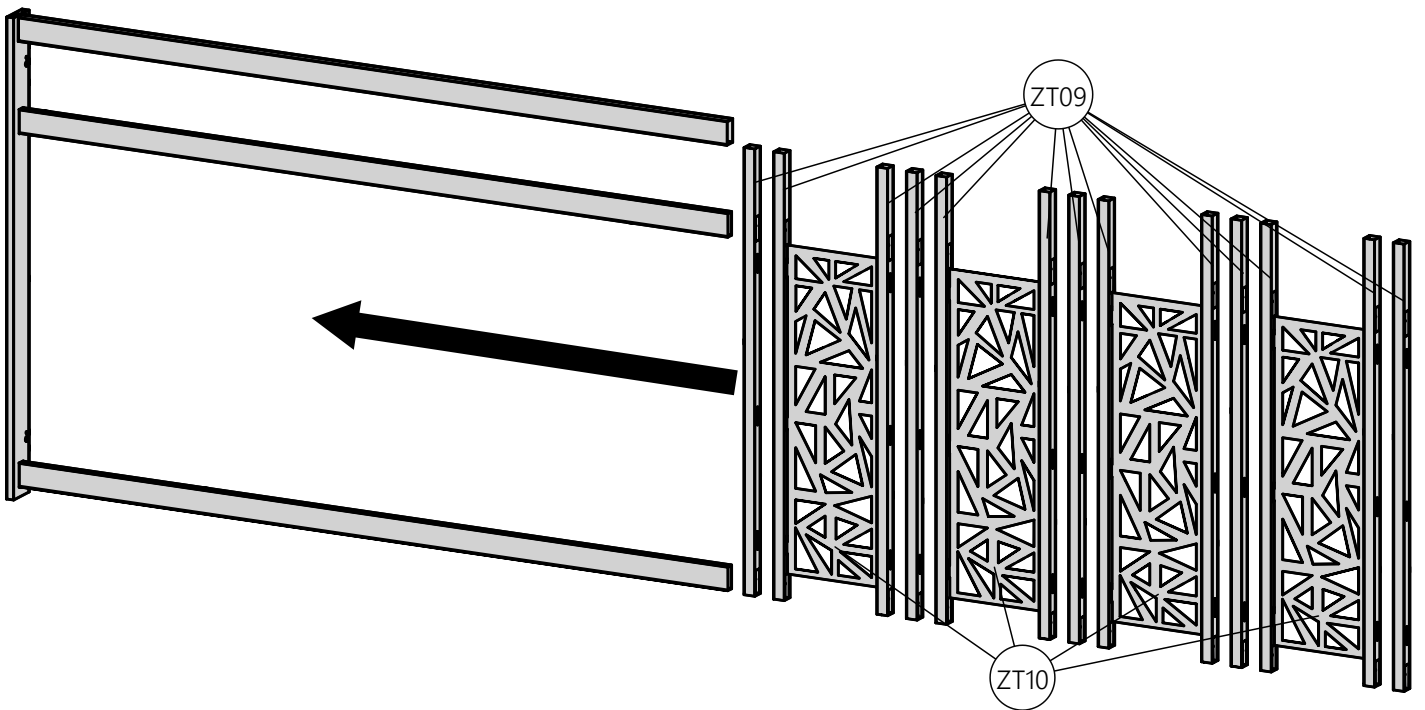
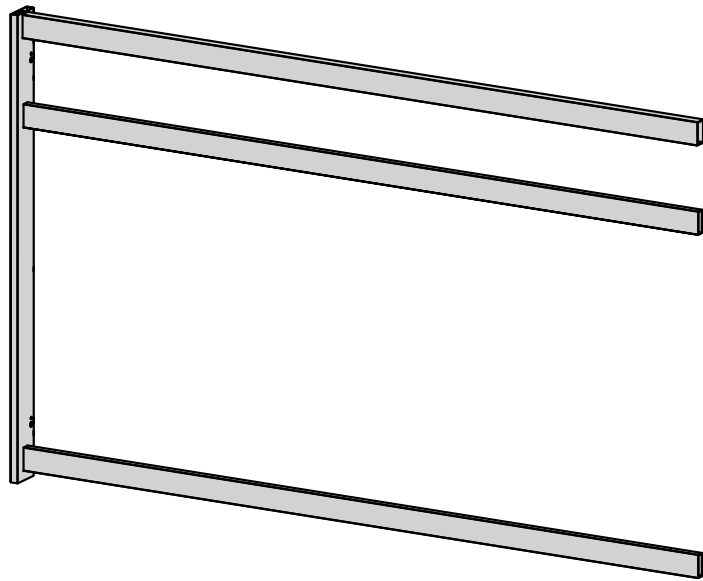

8

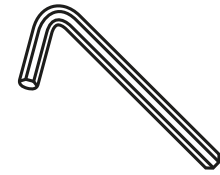

3mm

A

B

C

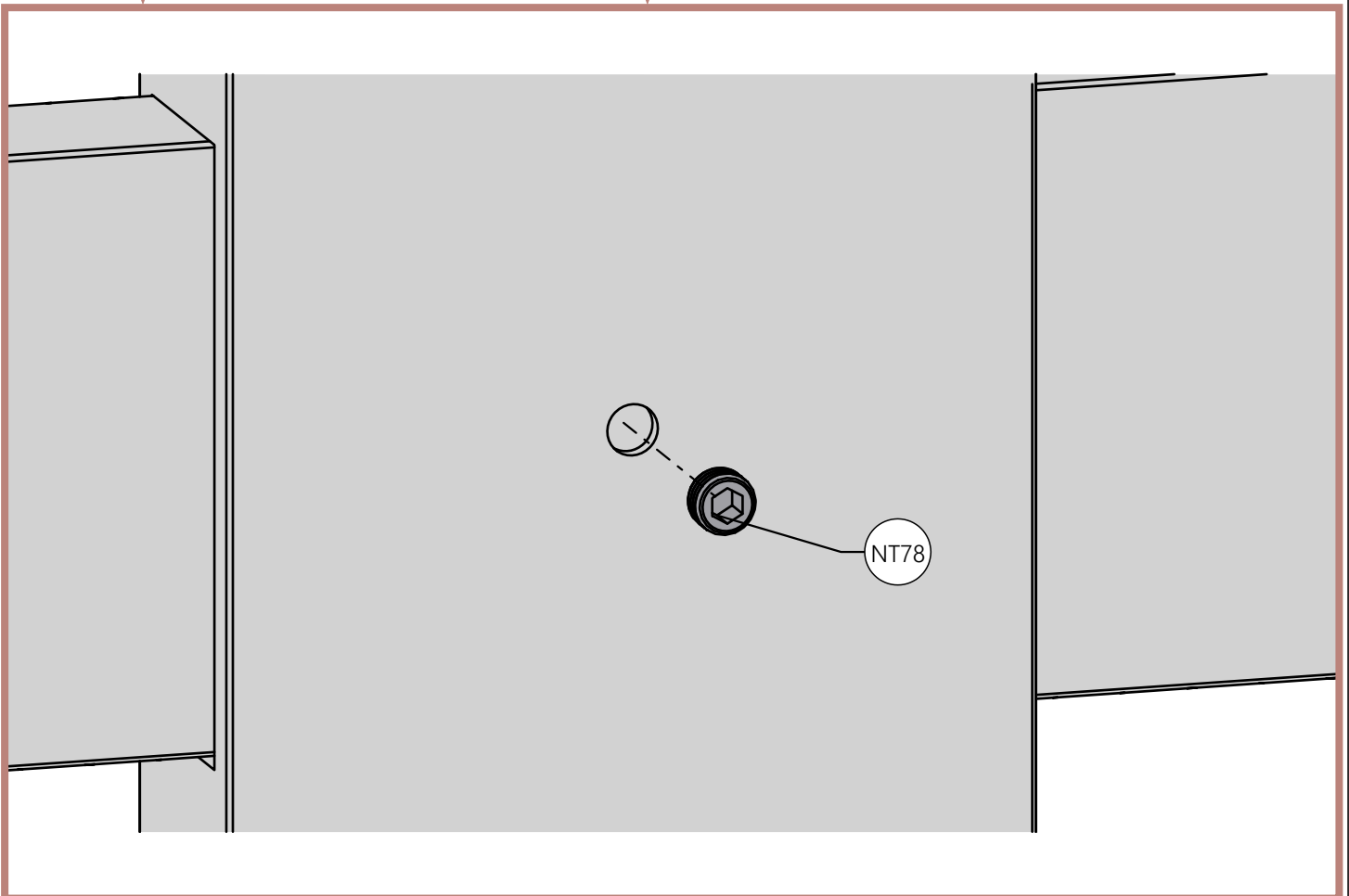
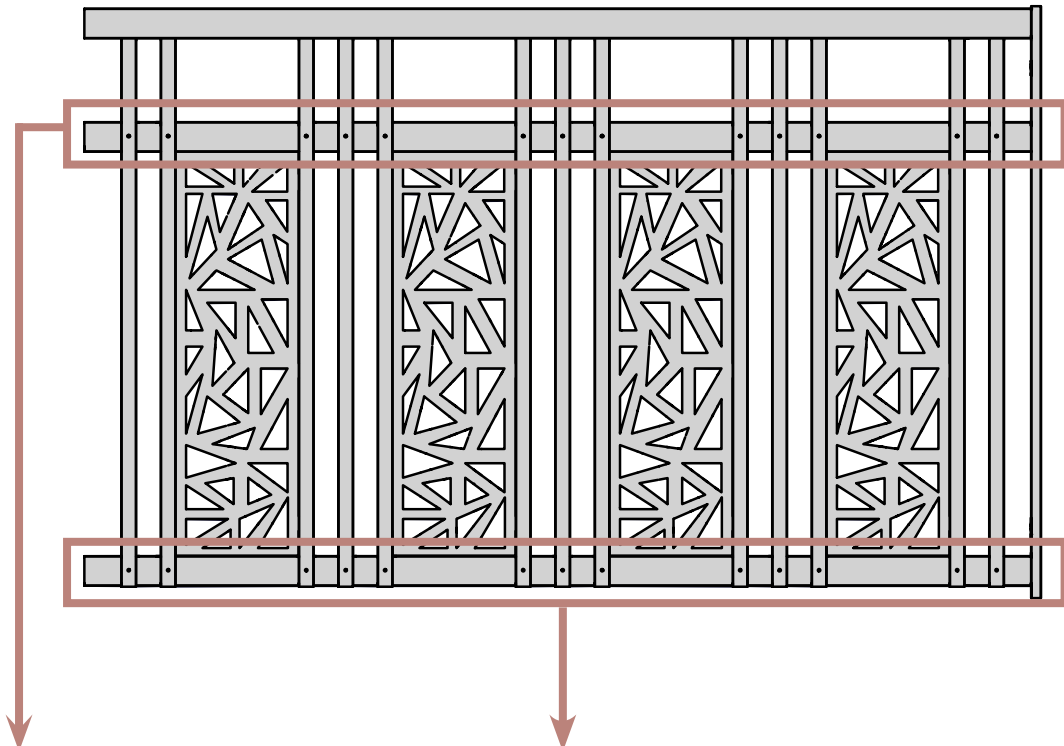

9

A

B

C

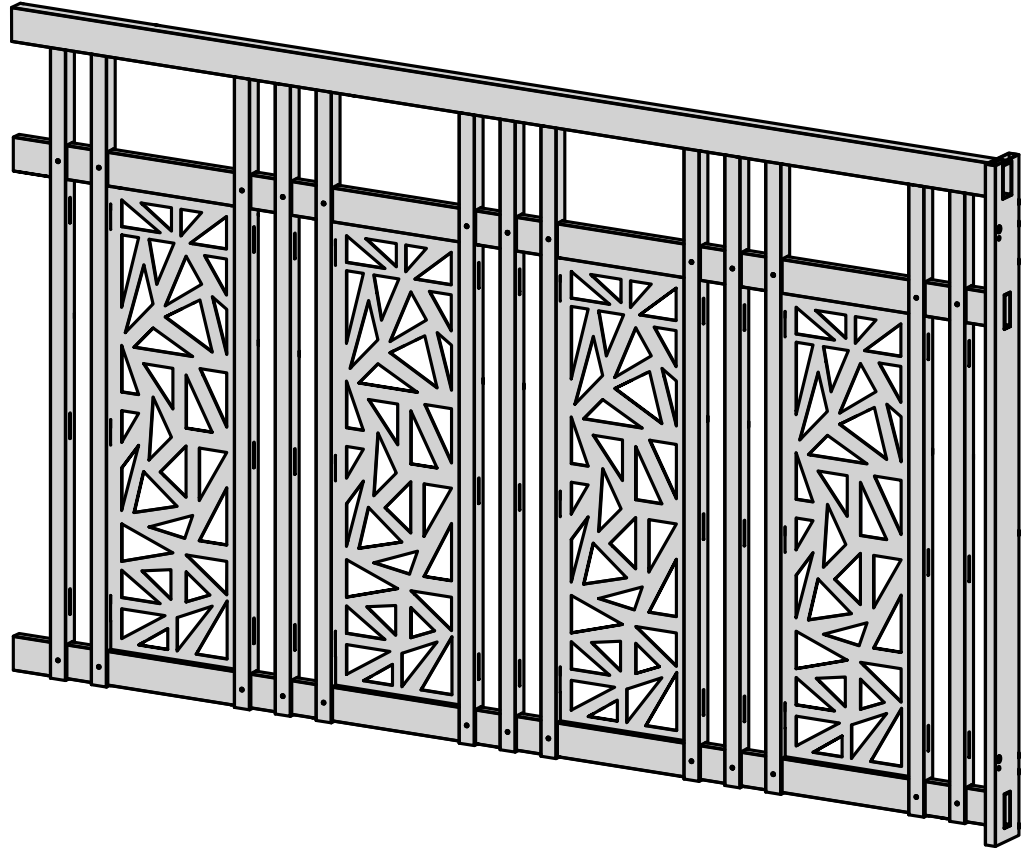

ZT06

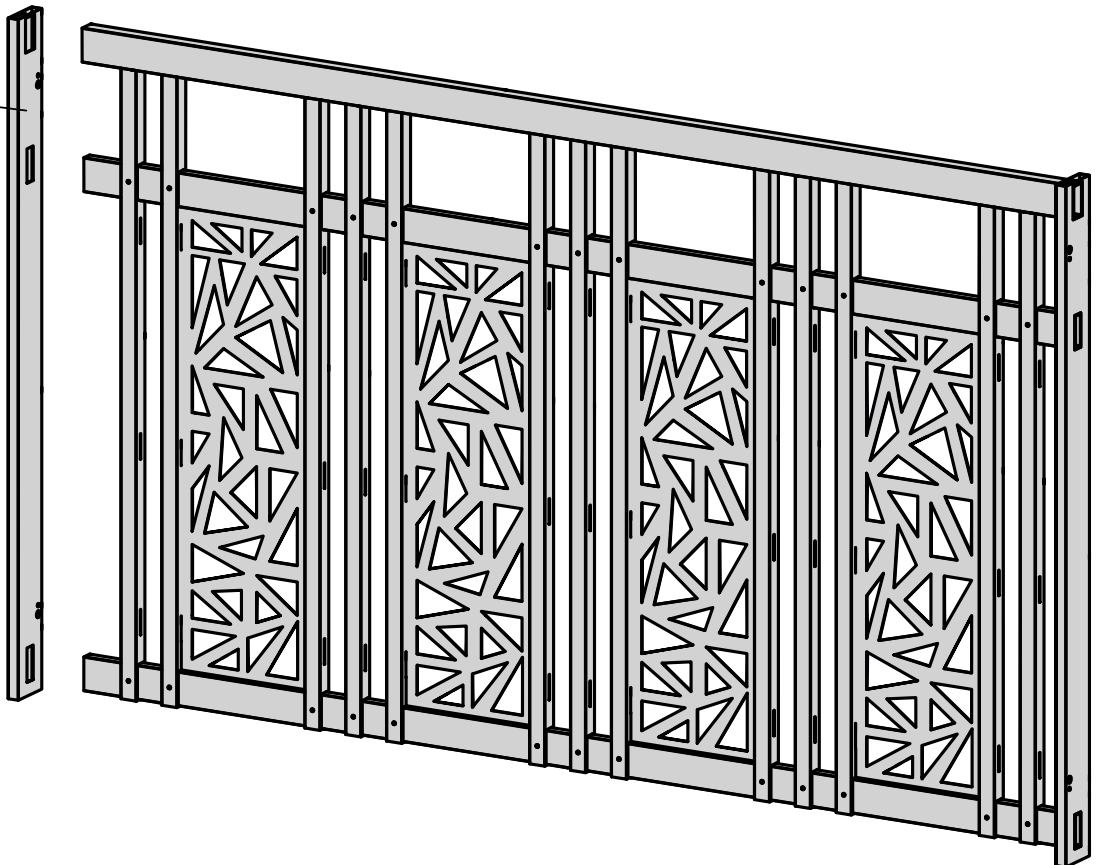

10

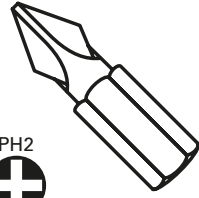

A

B

C

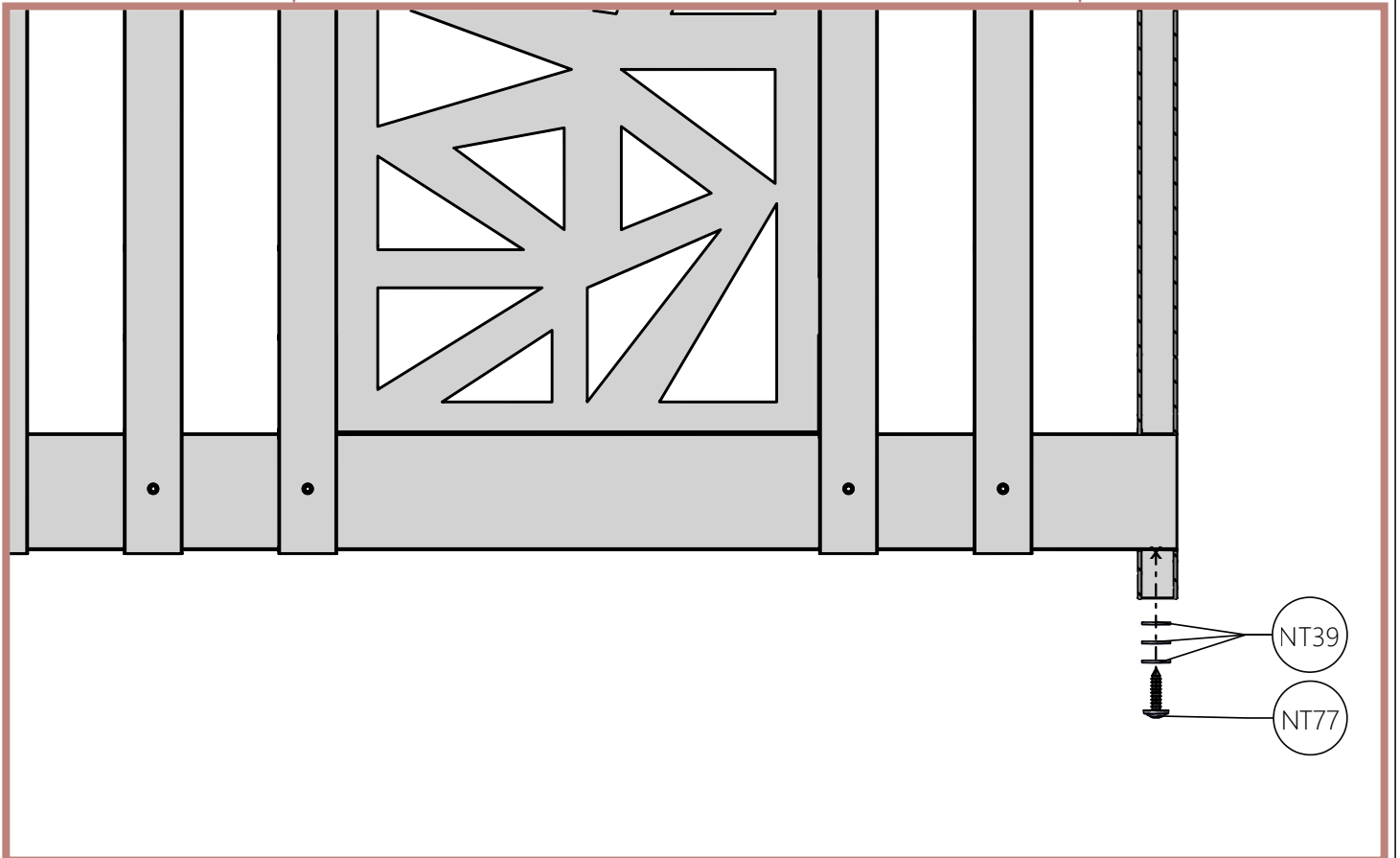
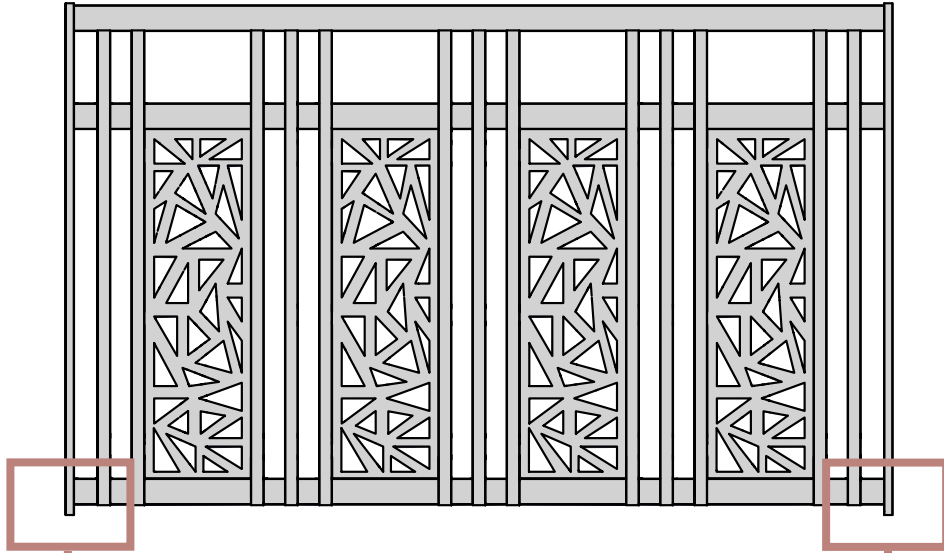

NT39

NT77

11

A

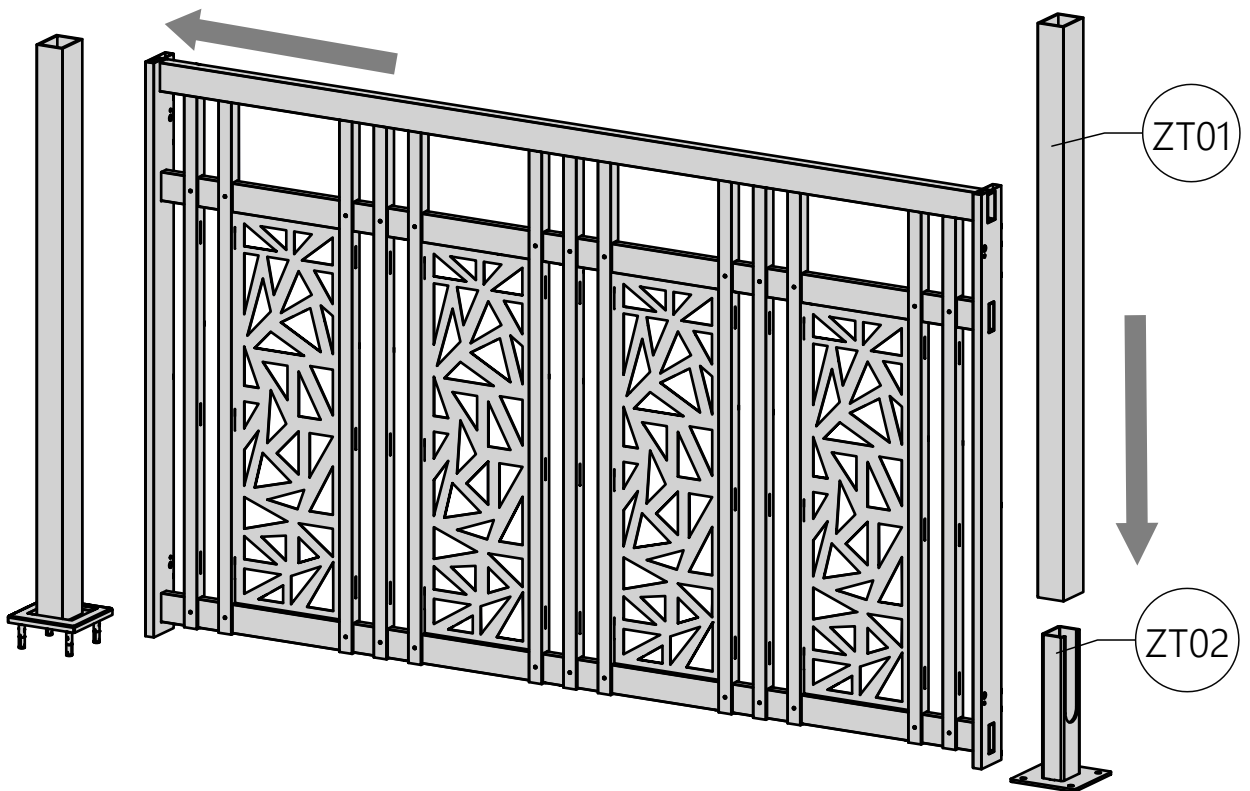
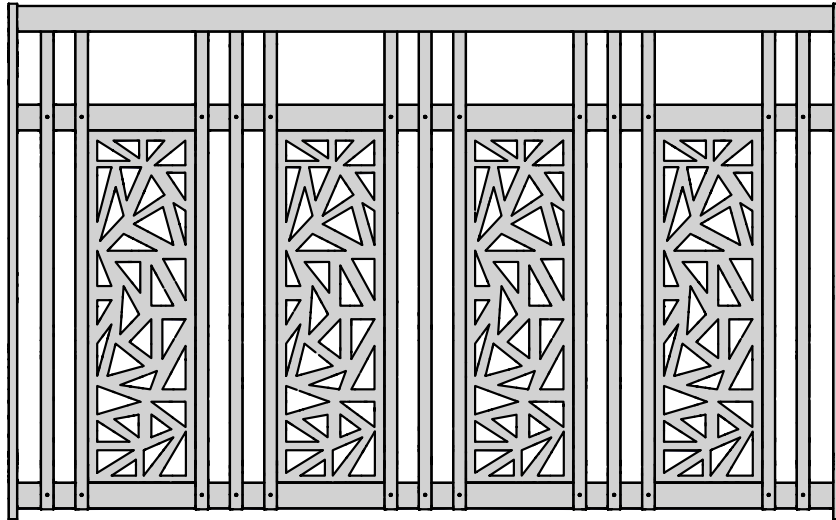

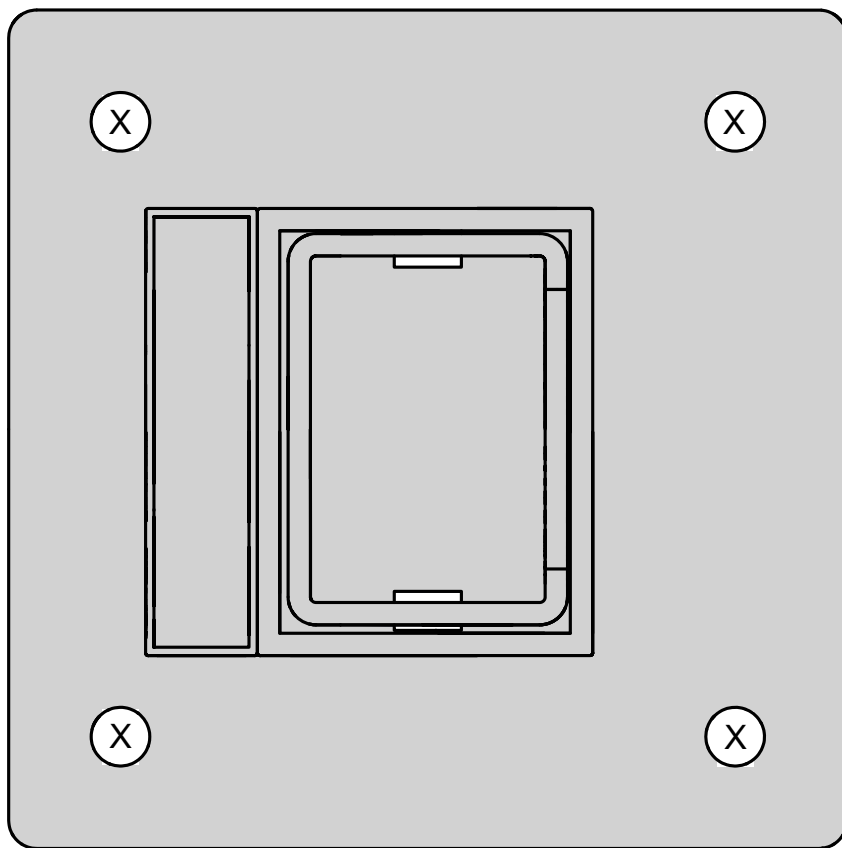
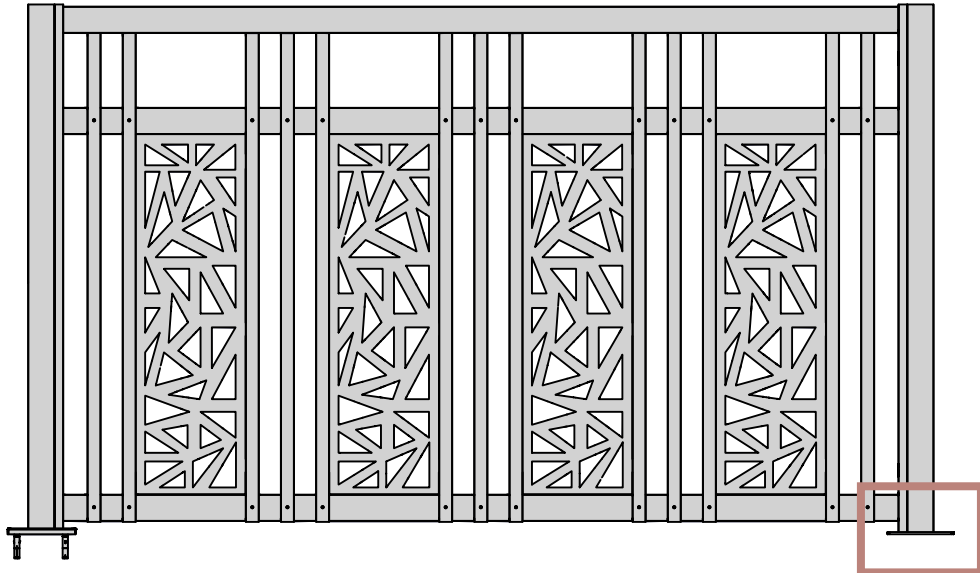
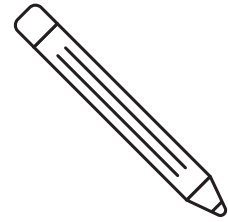

13

A

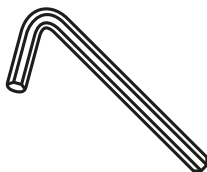

5mm

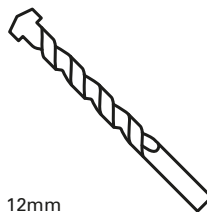
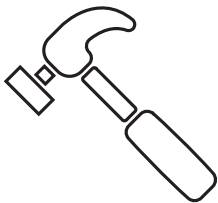

12mm

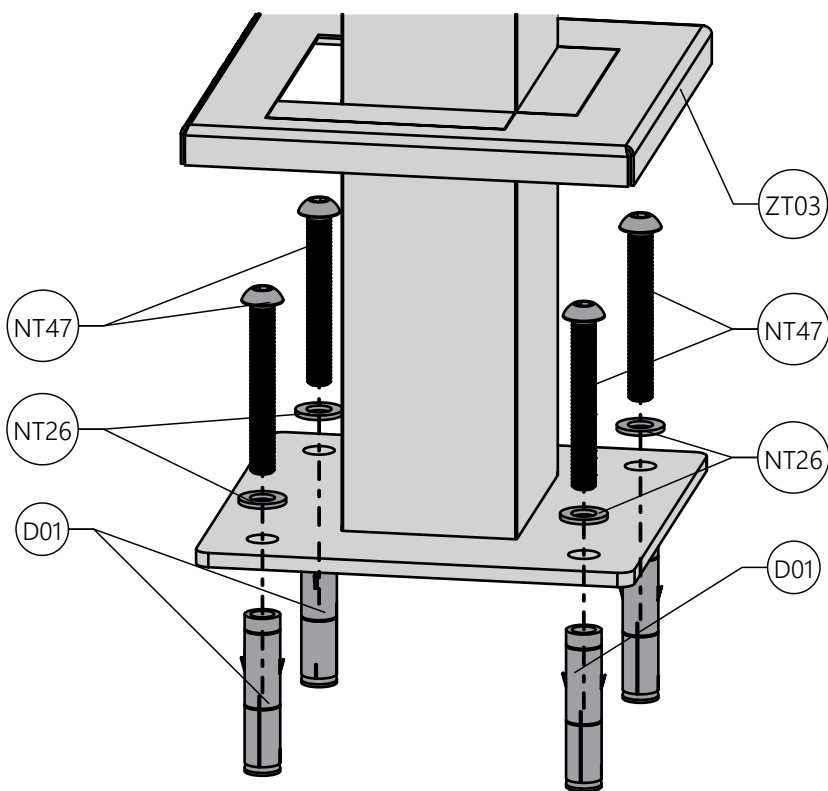
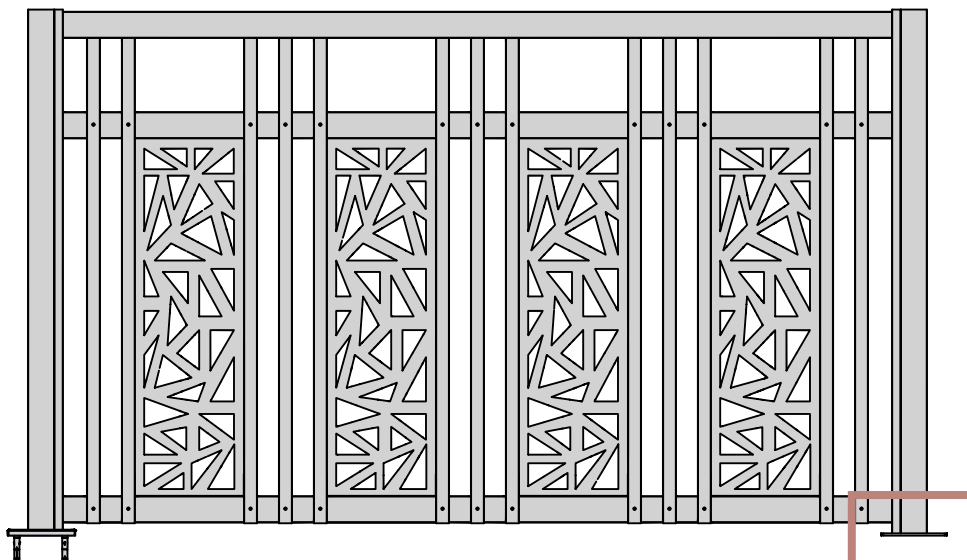
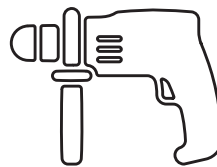

14

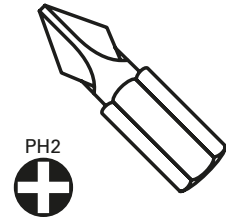

A

B

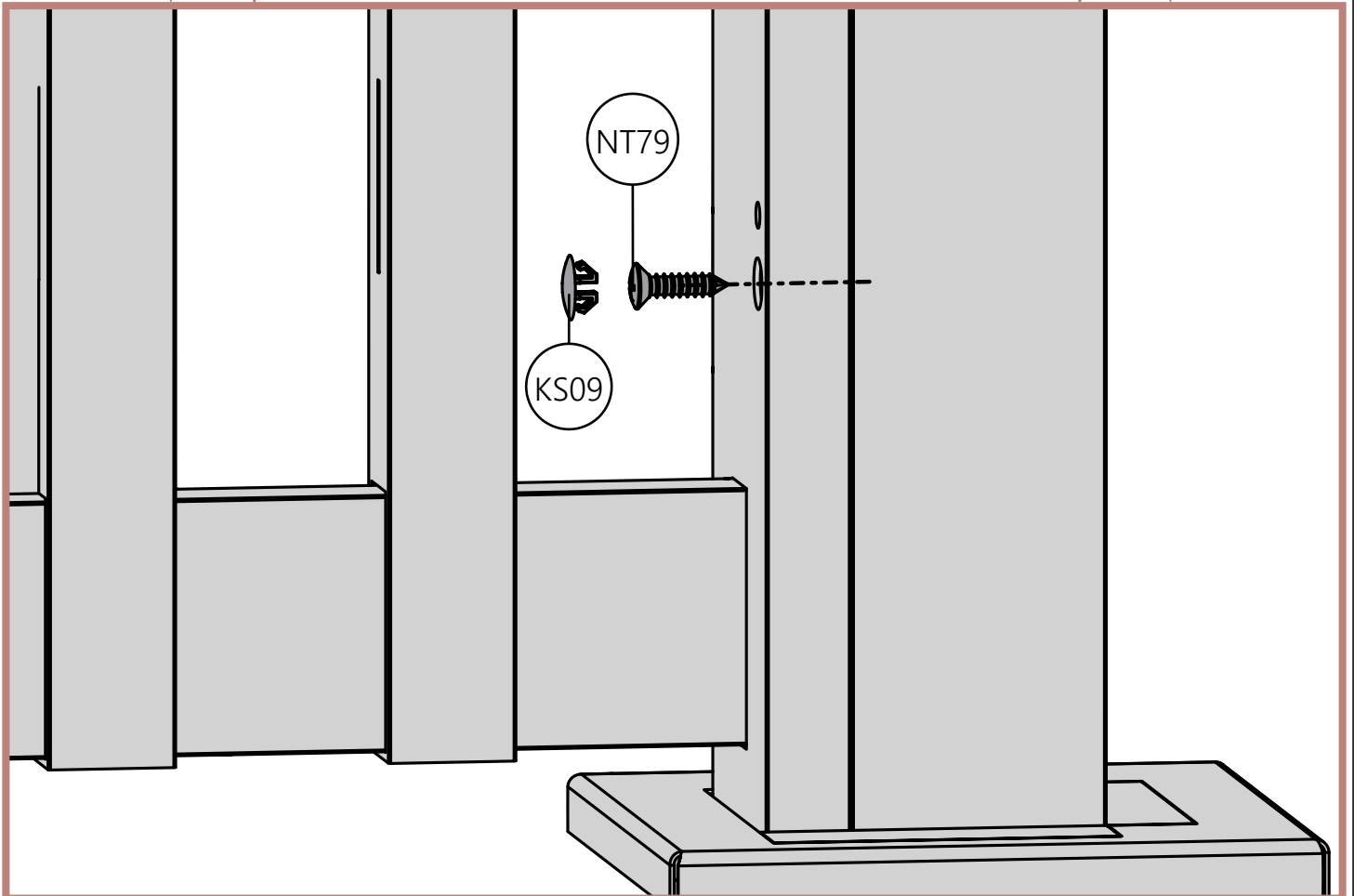
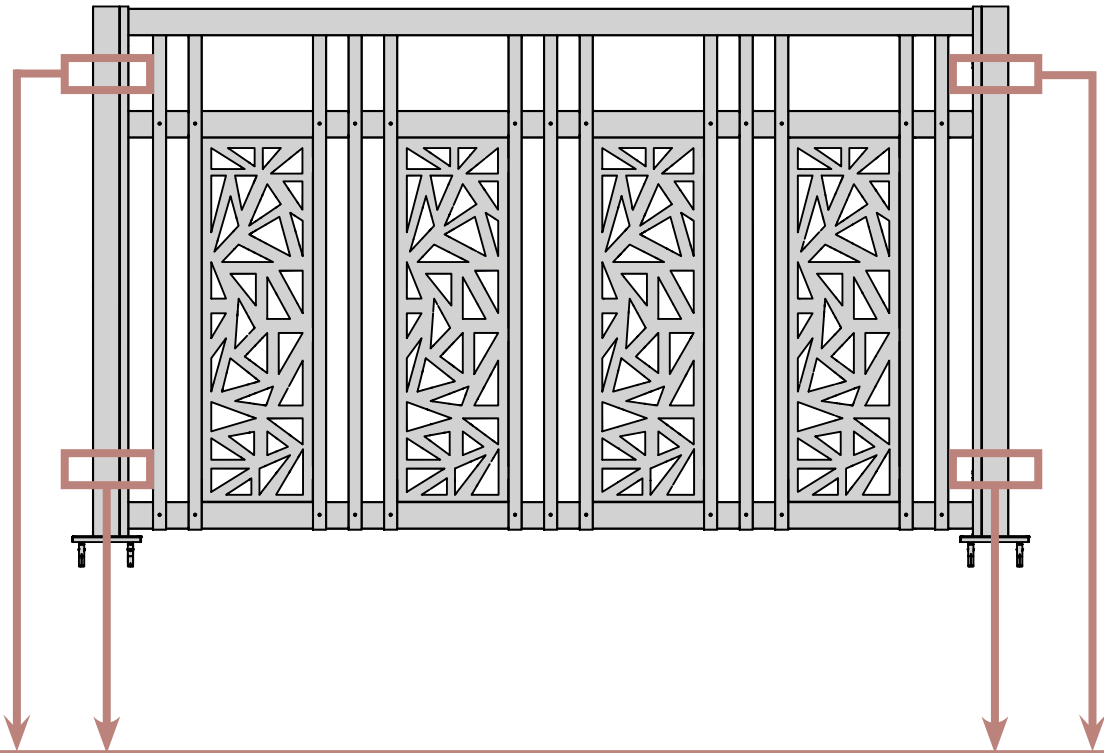

15

C

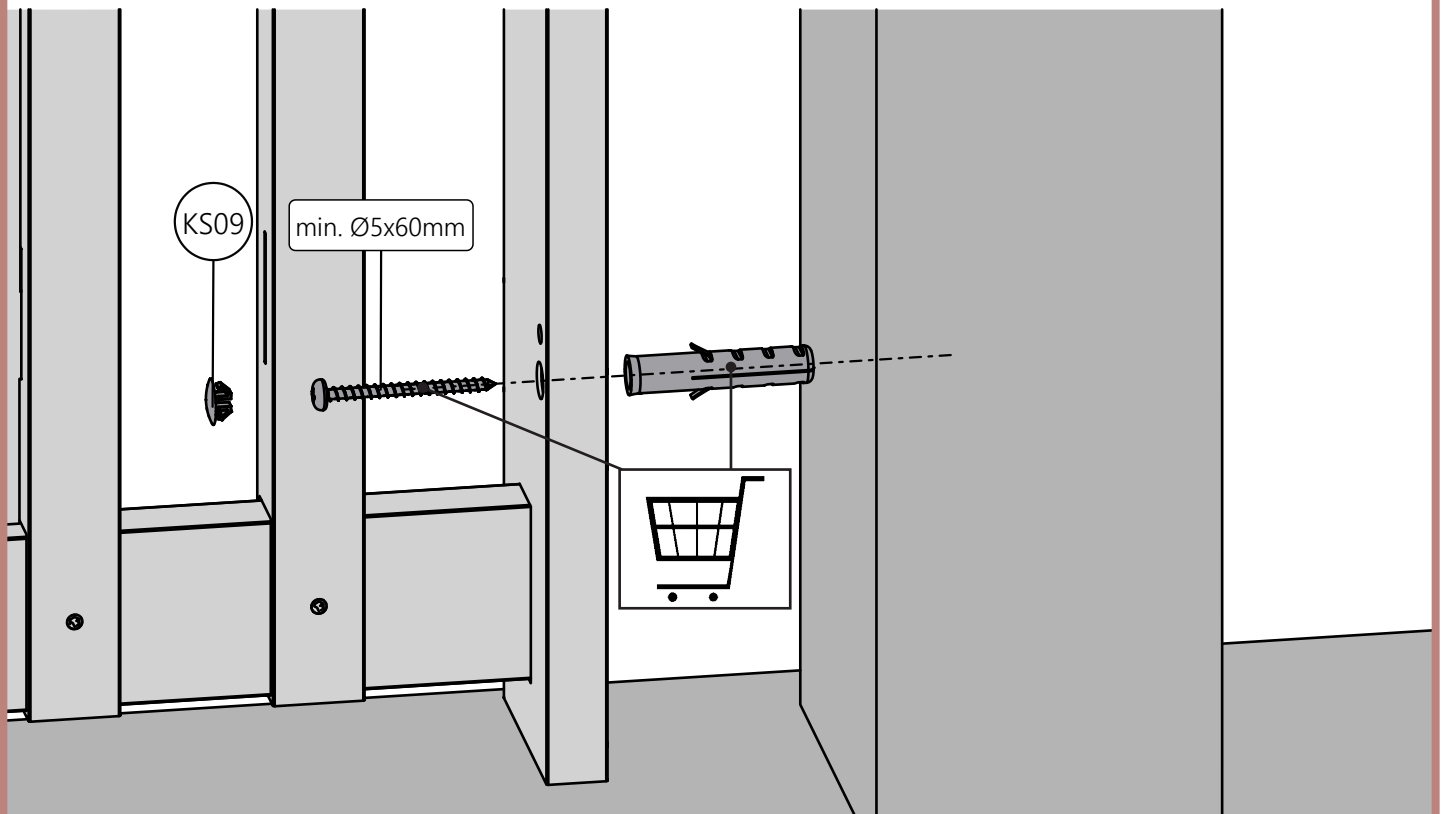
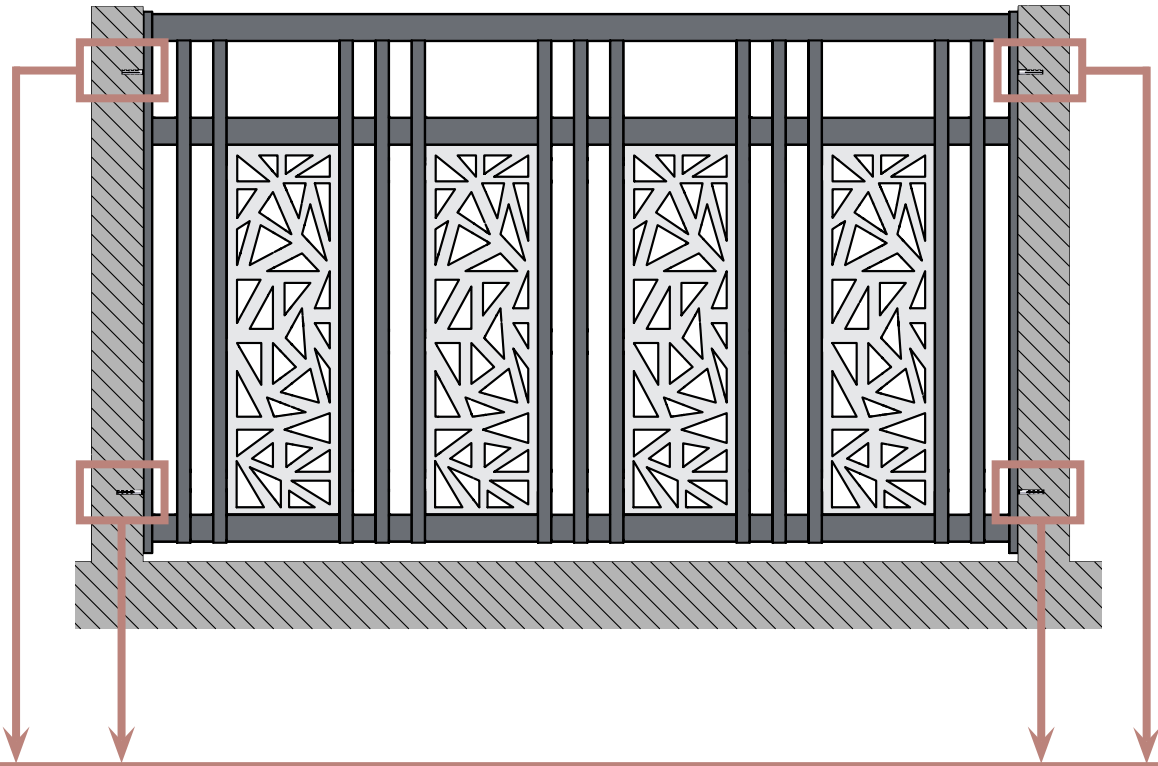
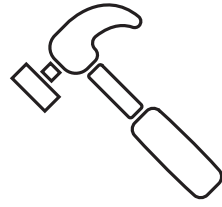
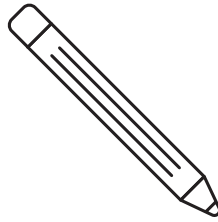
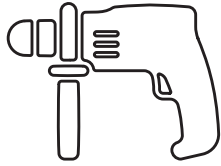
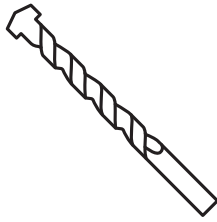

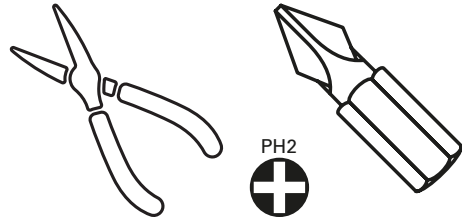

A

B

