

PLANO 120 LIGHT

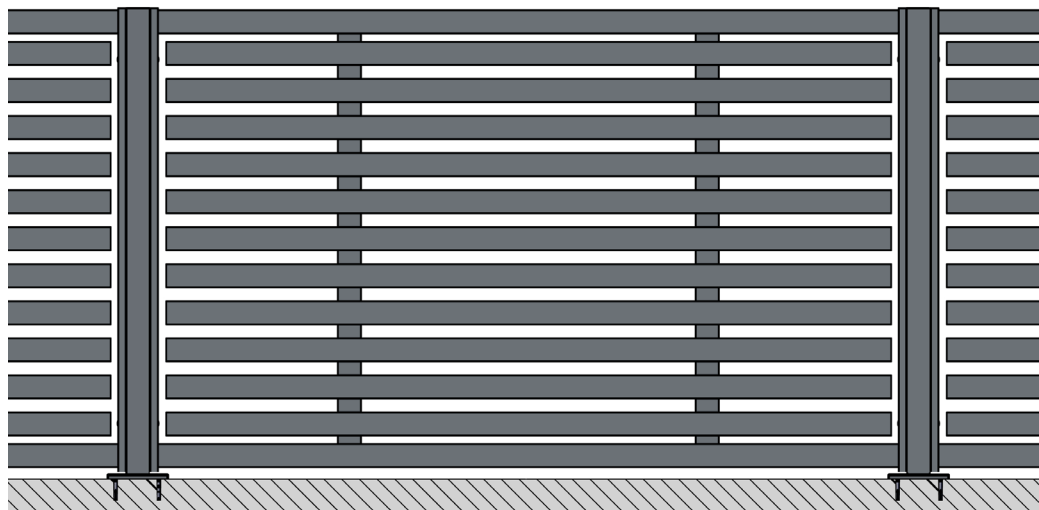

A



B

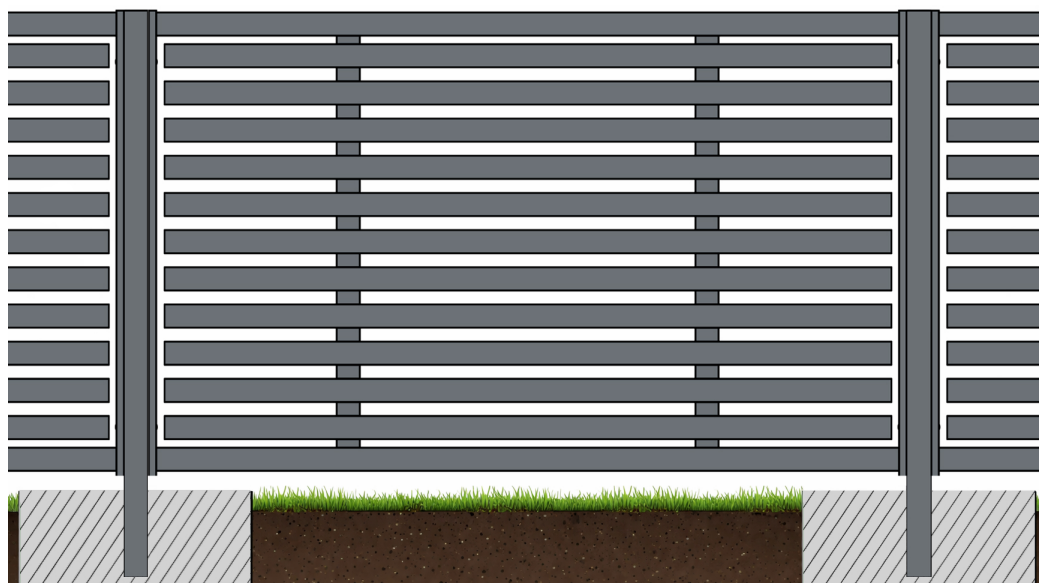

C



PLANO 120 LIGHT

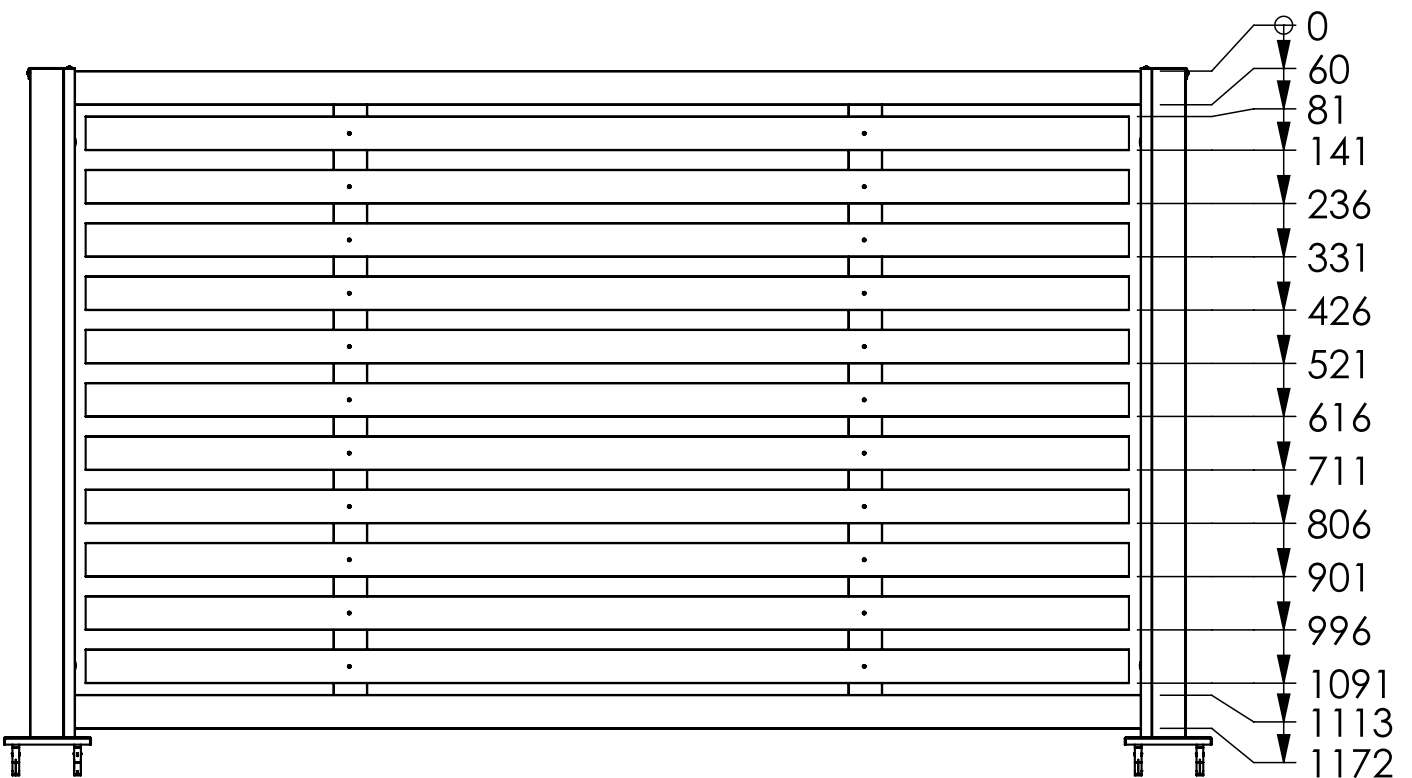
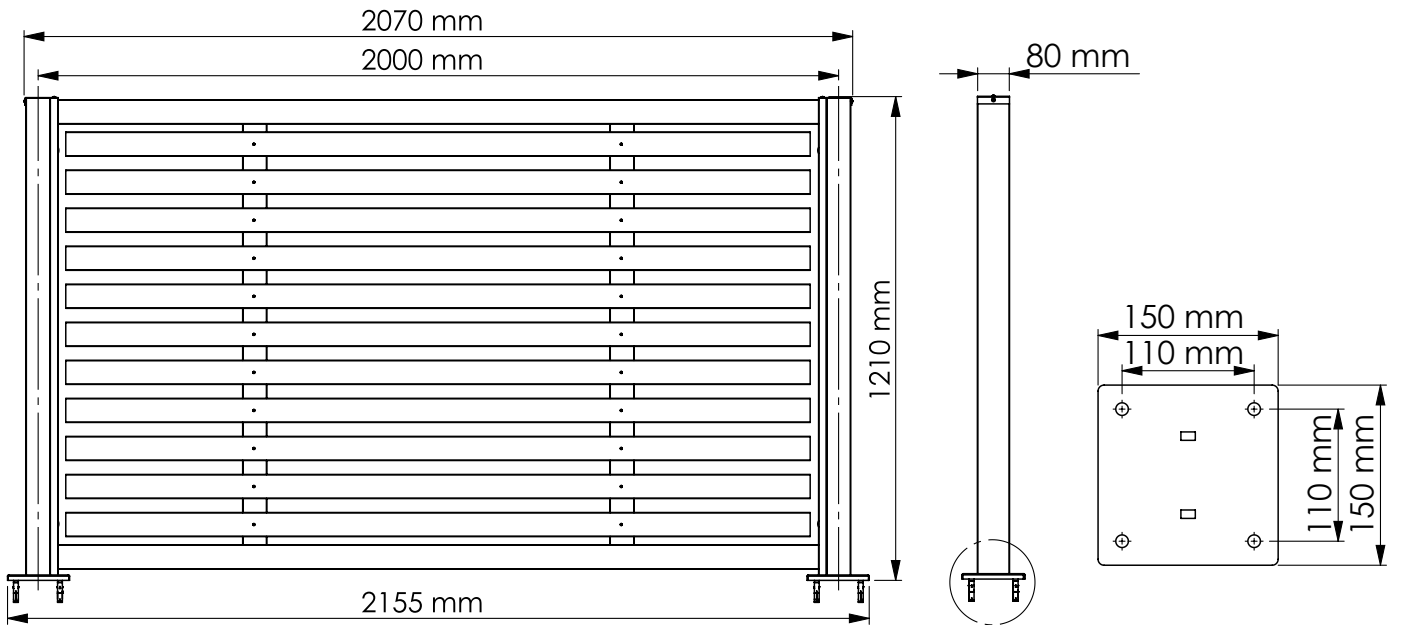

PLANO 120 LIGHT



8x

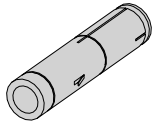

D01

M8x55 mm

4x

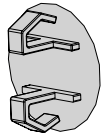

KS09

Ø13 mm

22x

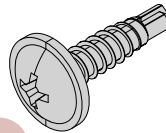

NT07

Ø4,2x19 mm

8x

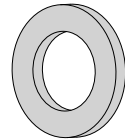

NT26

M8 DIN125A

12x

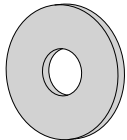

NT39

M5 DIN9021

8x

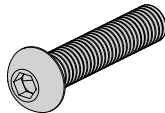

NT47

M8x60 mm ISO7380-1

6x

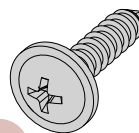

NT77

Ø3,5x16 mm

4x

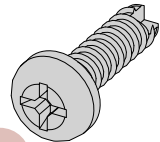

NT79

Ø5,5x22 mm

2x

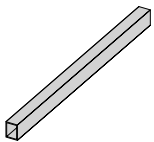

ZT01

80x60x1200 mm

2x

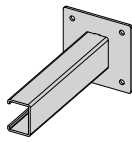

ZT02

2x

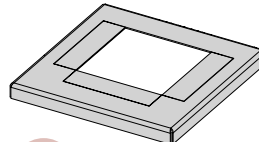

ZT03

2x

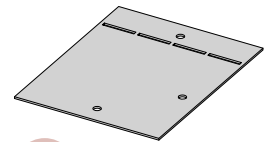

ZT04

2x

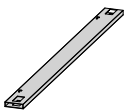

ZT20

80x20x1200 mm

2x

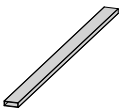

ZT21

60x20x1168 mm

11x

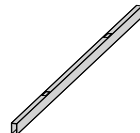

ZT22

60x30x1860 mm

2x

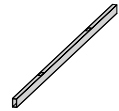

ZT52

60x30x1940 mm

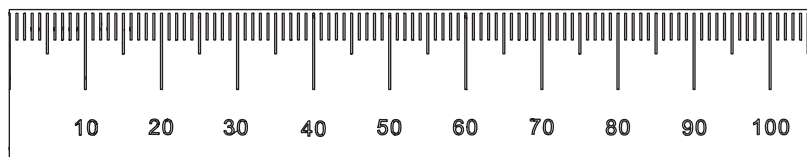
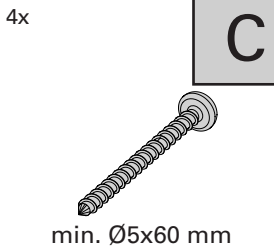
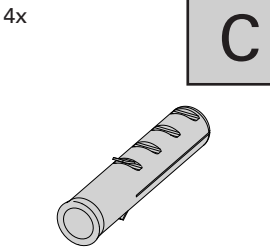
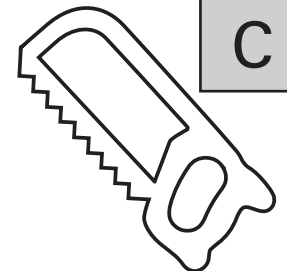
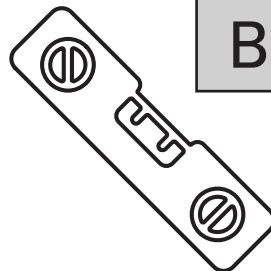
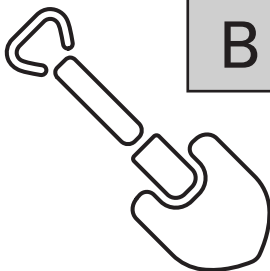
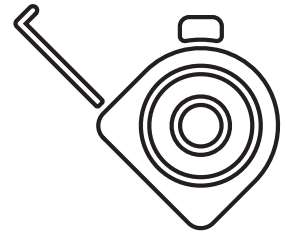
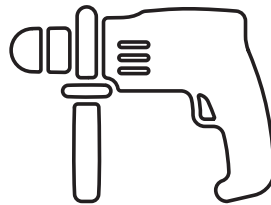
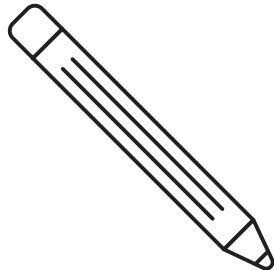
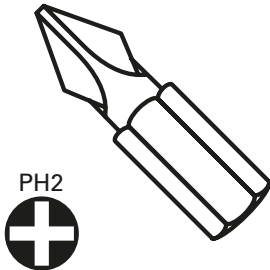
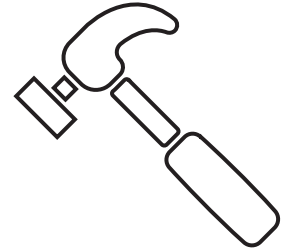
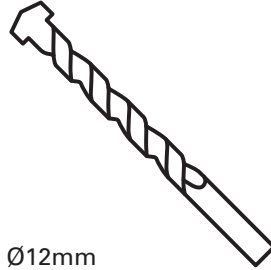
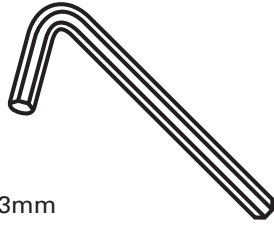
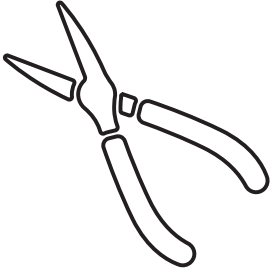

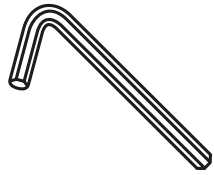
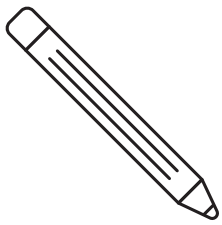

5mm

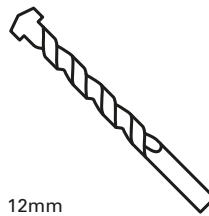
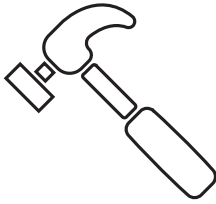

12mm

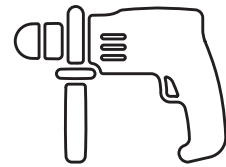

1

A

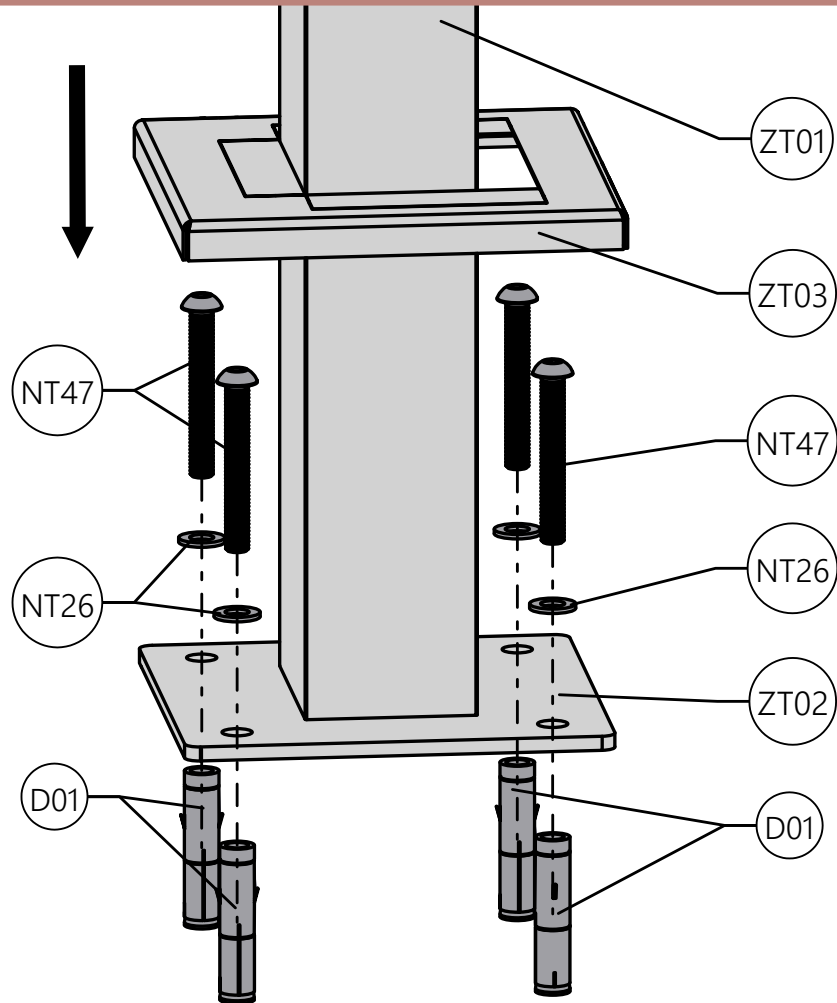
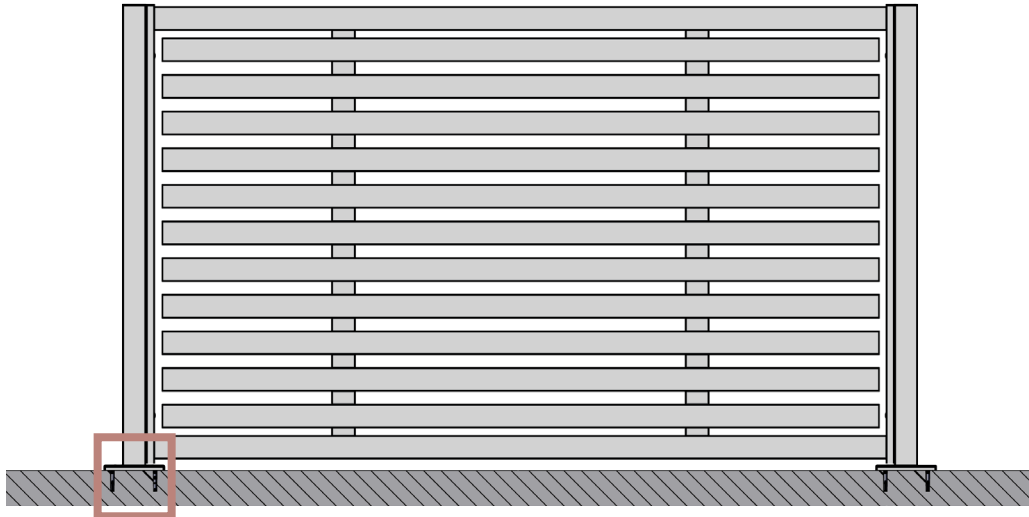

2

B

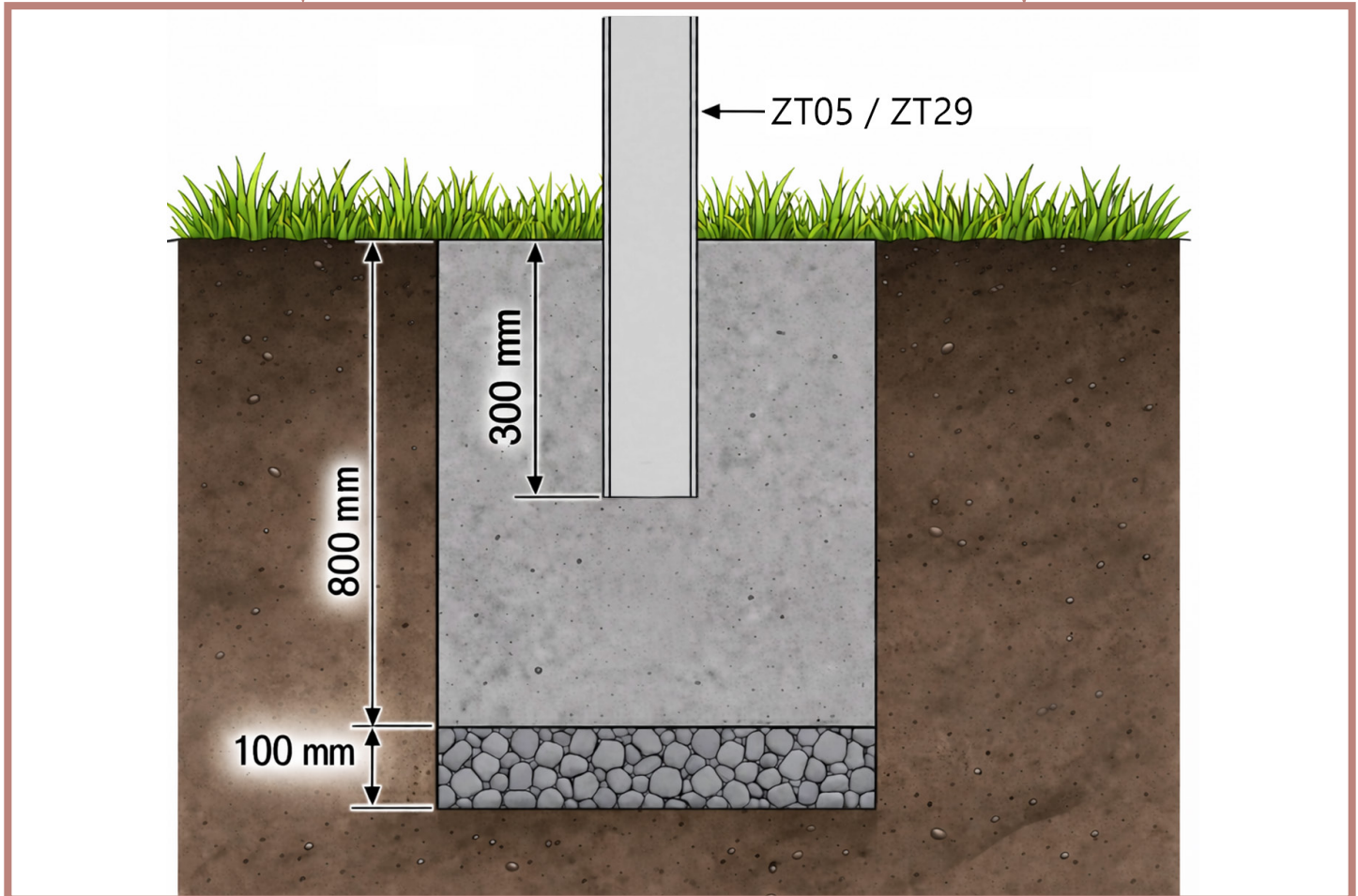
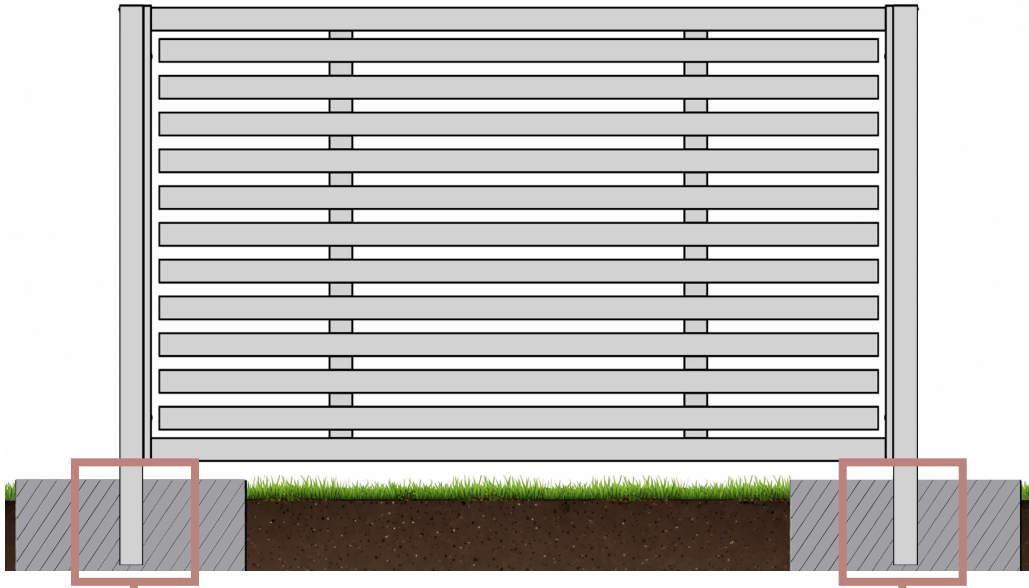
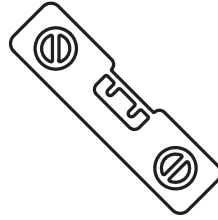
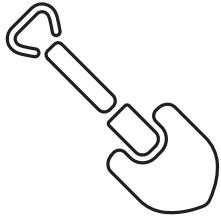

3

C

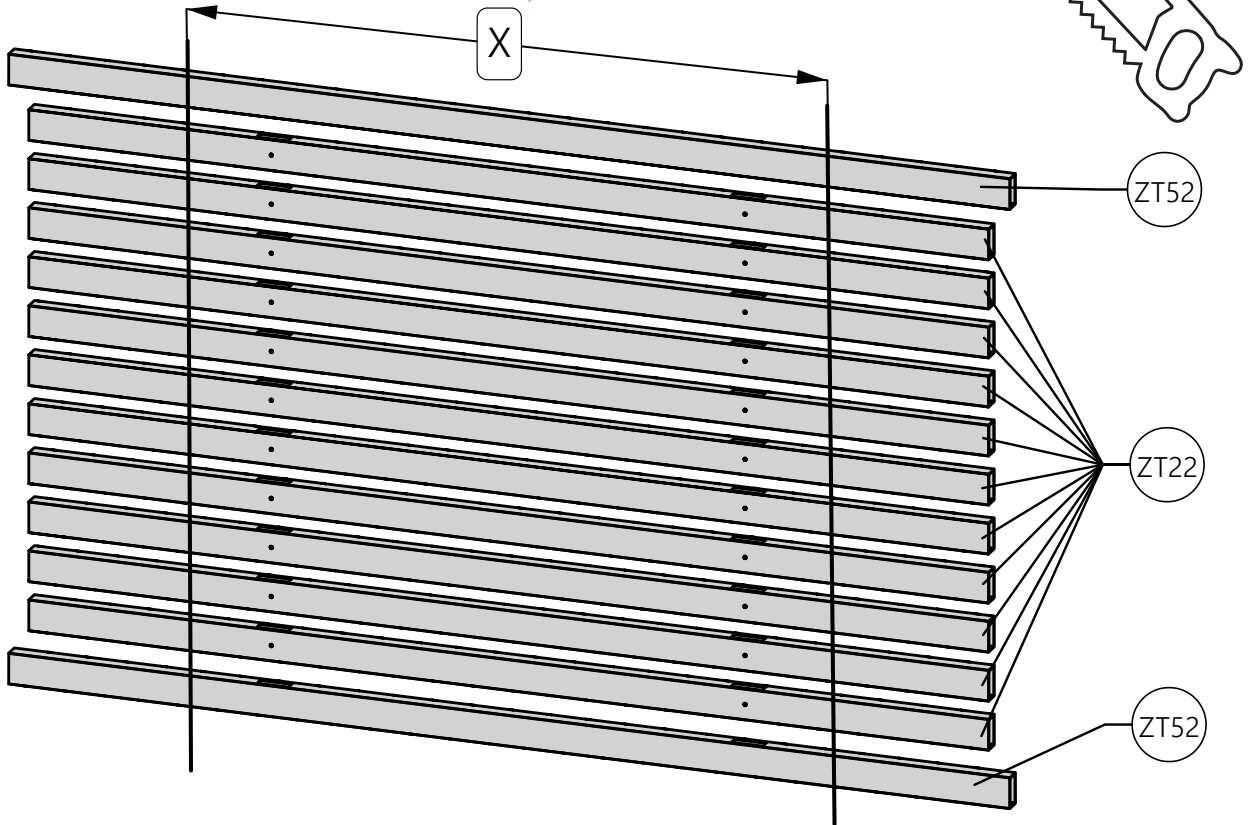
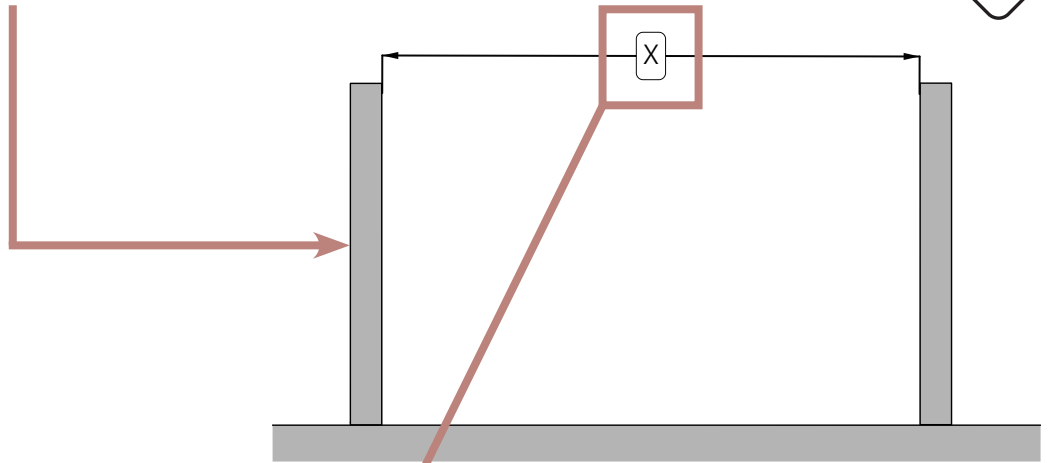
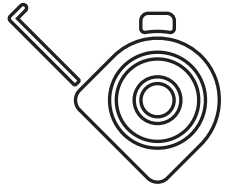
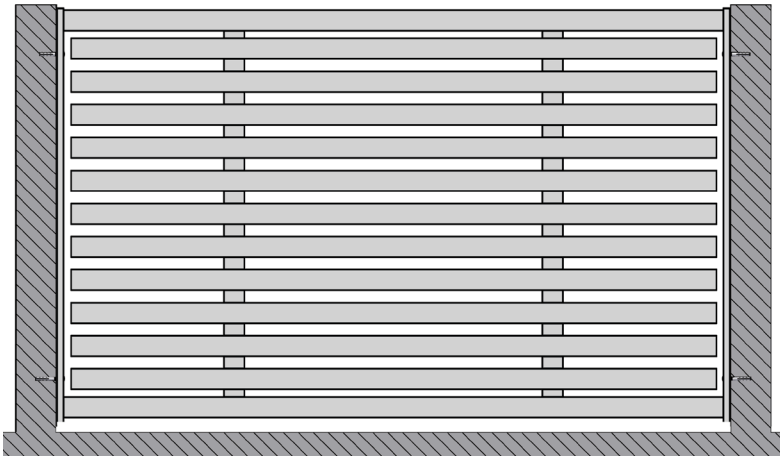

4

A

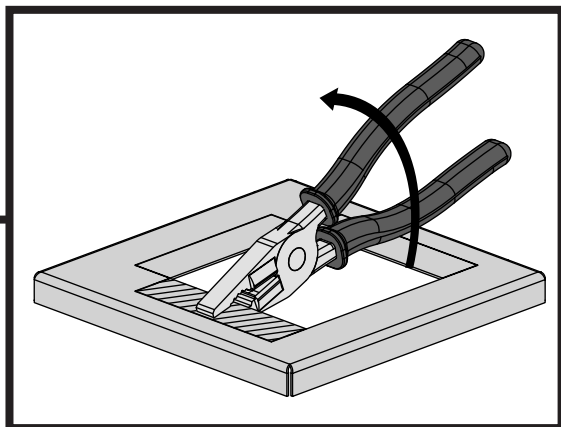
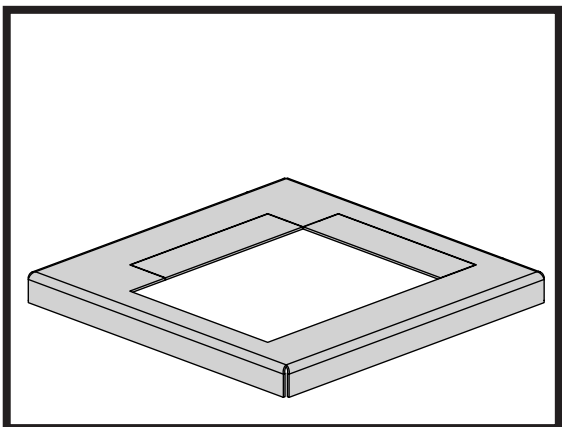
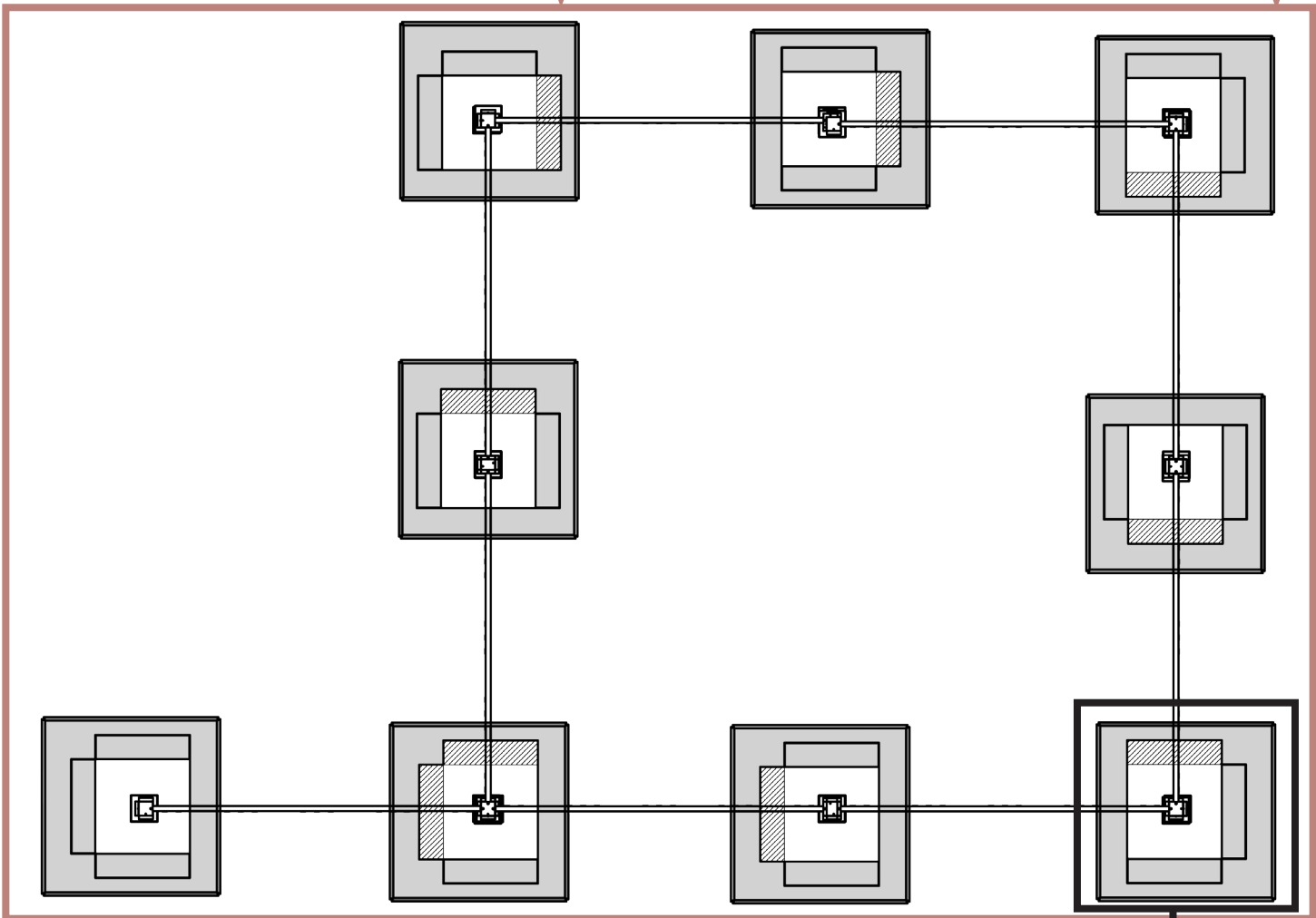
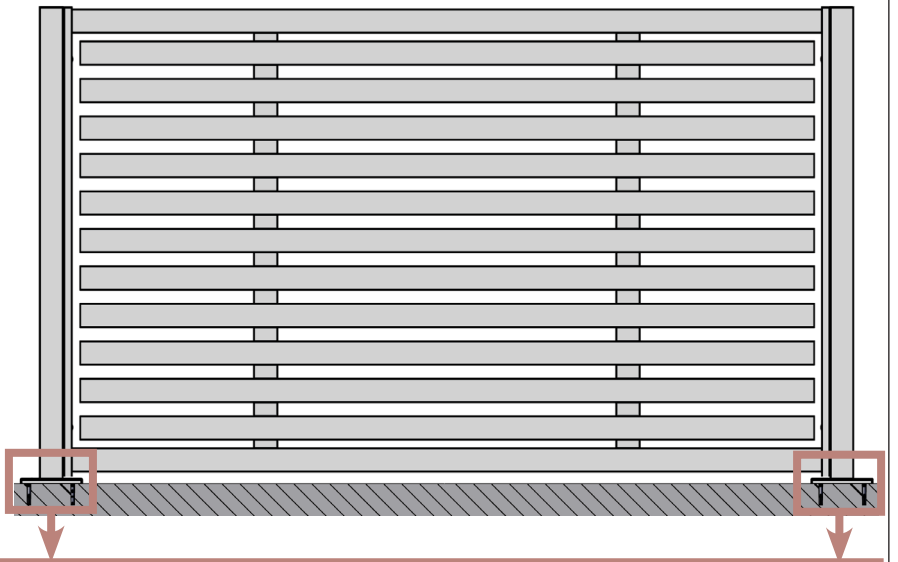

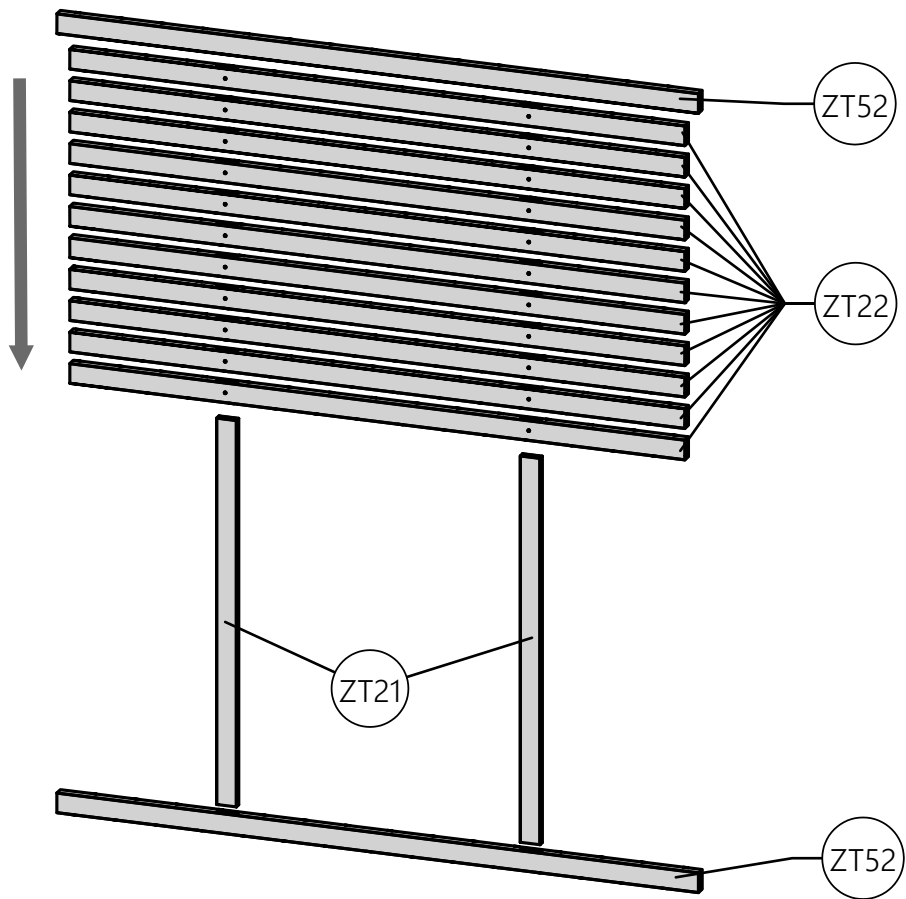
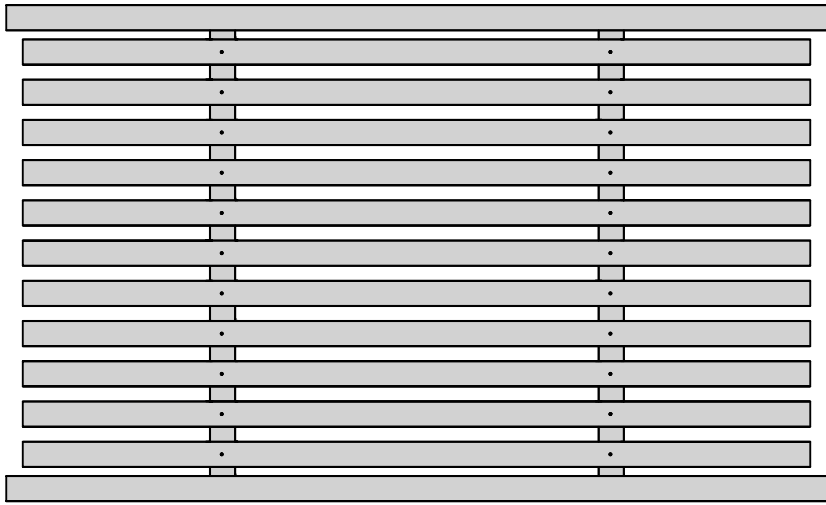

6

A

B

C

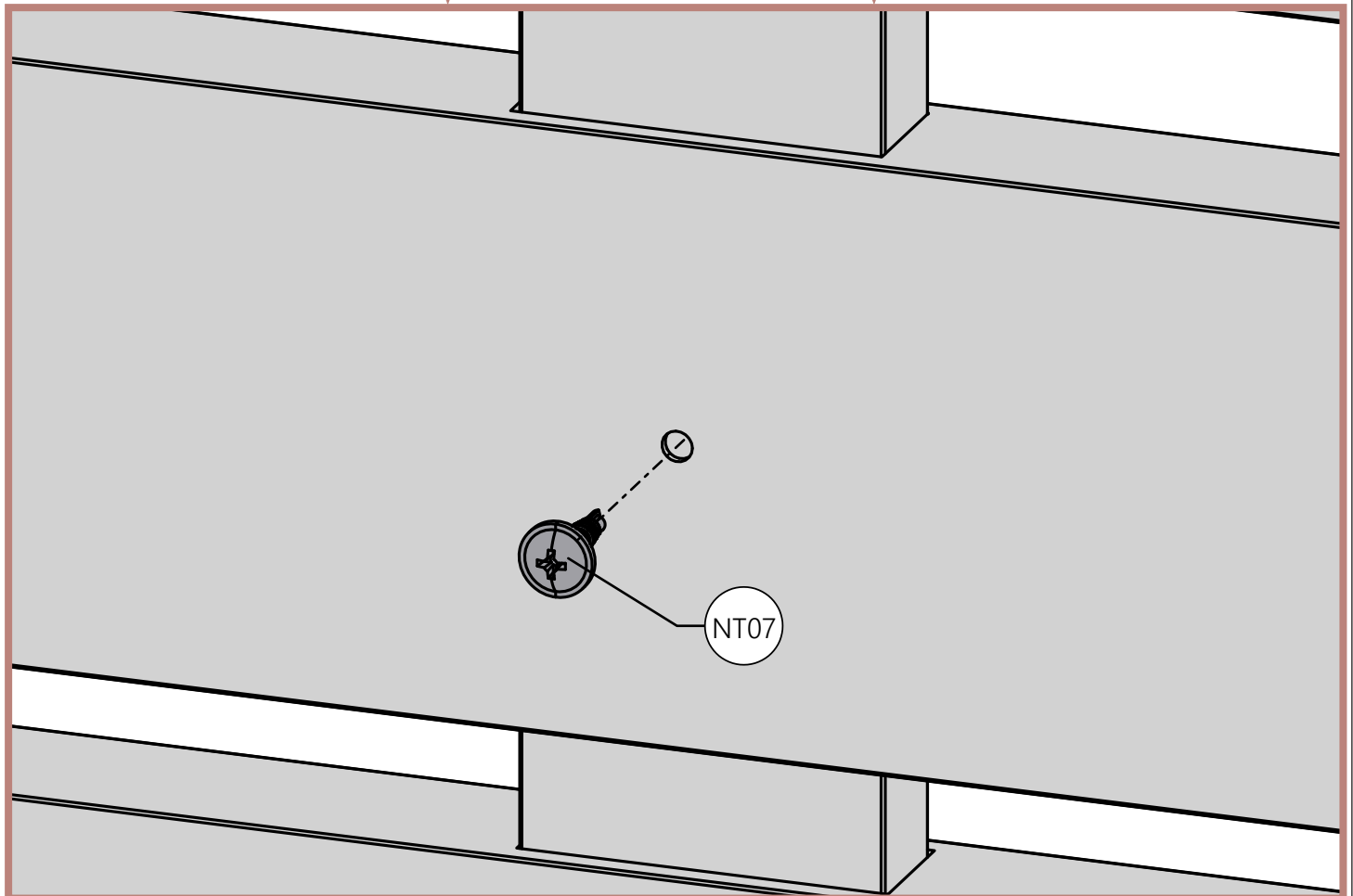
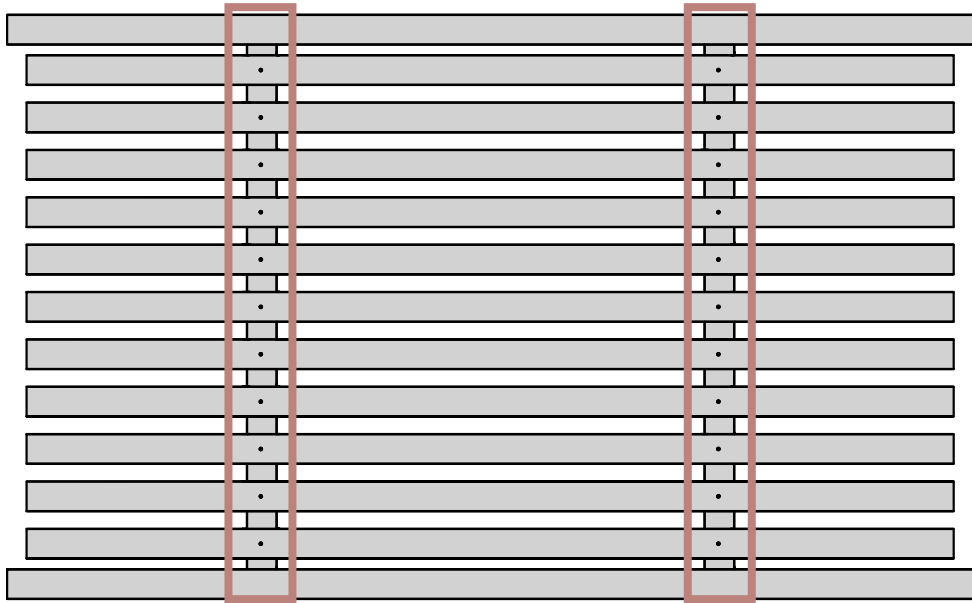
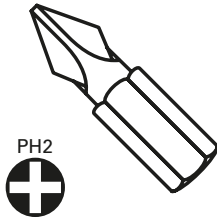

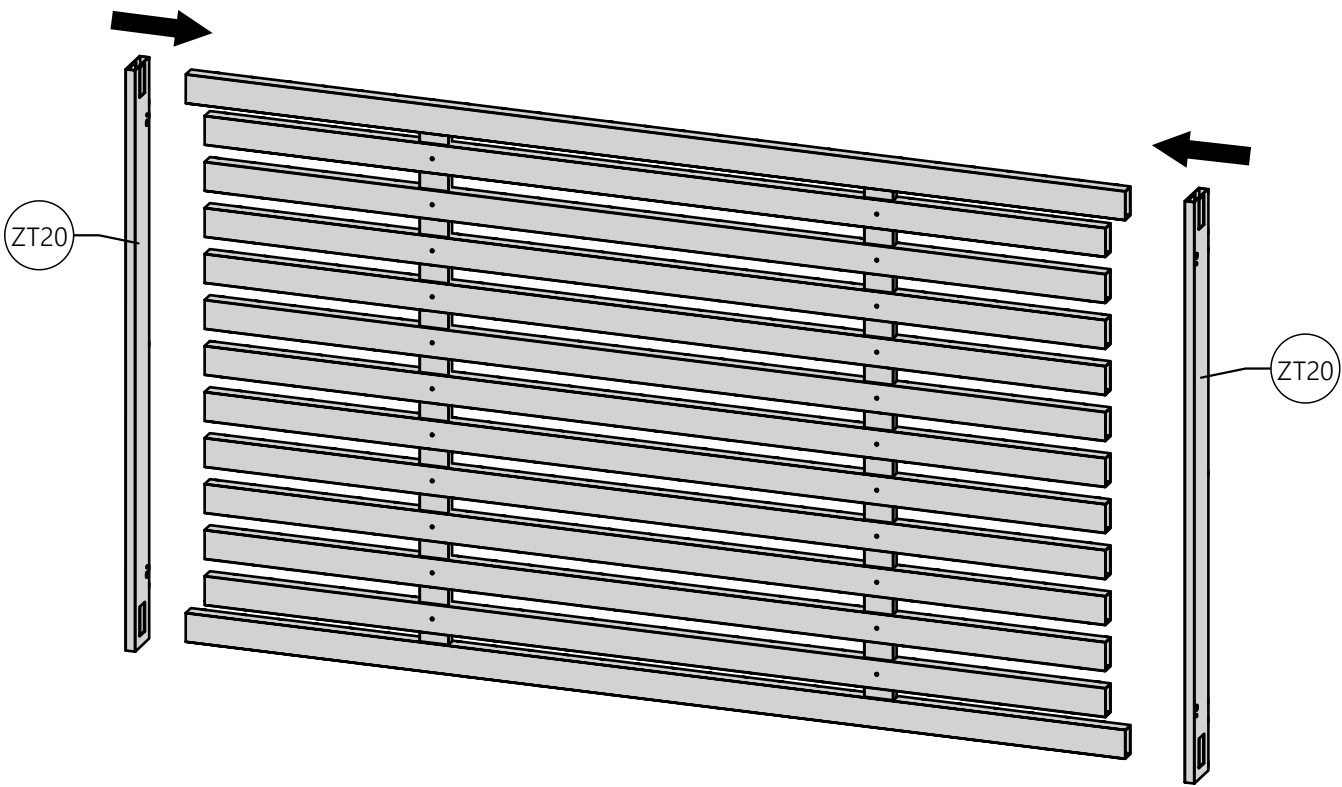
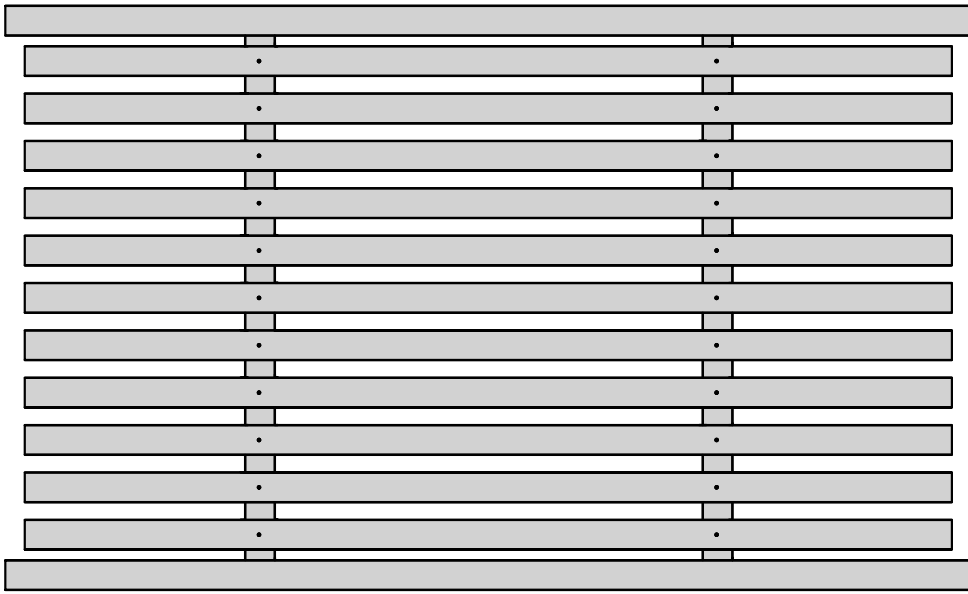

8

A

B

C

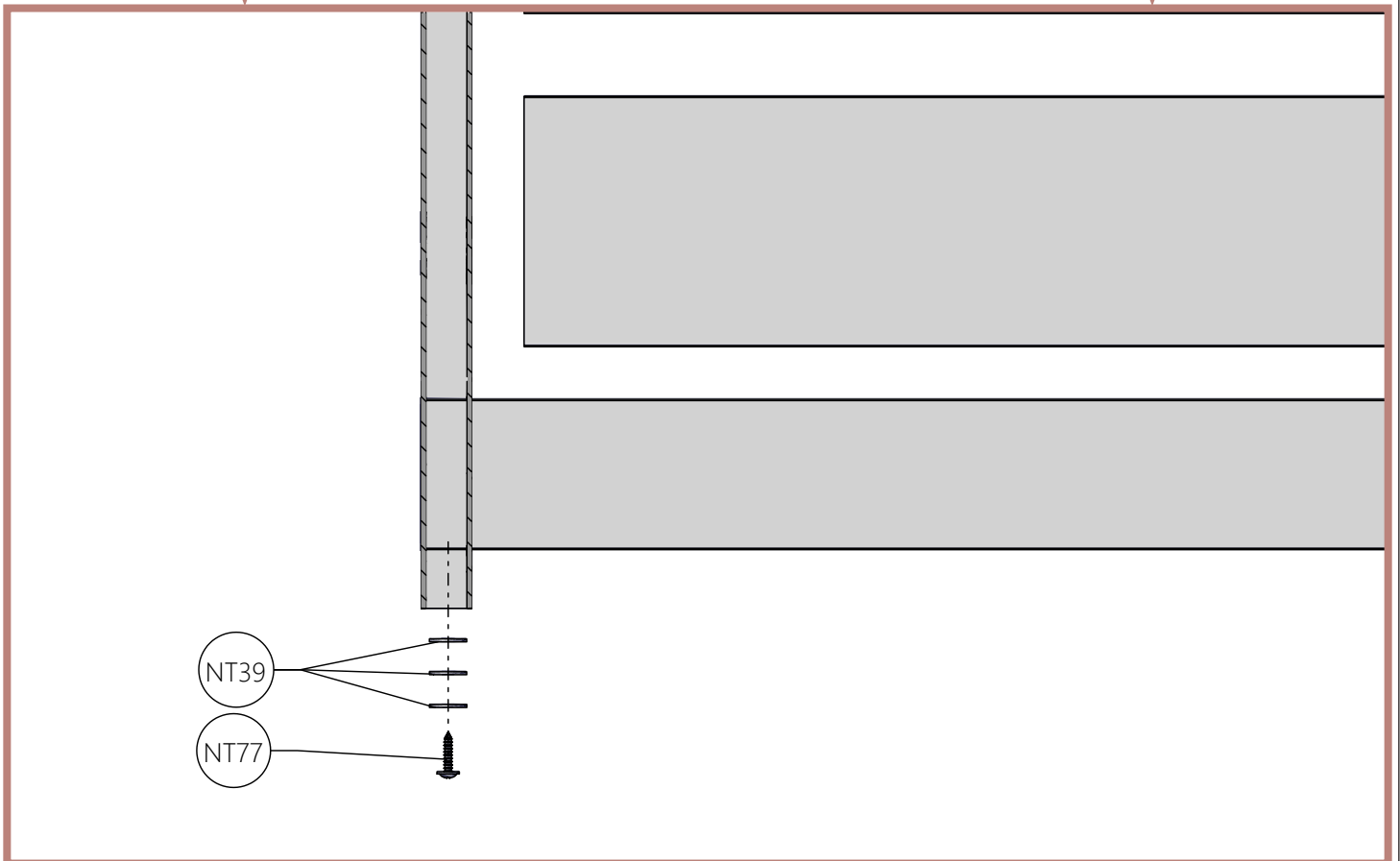
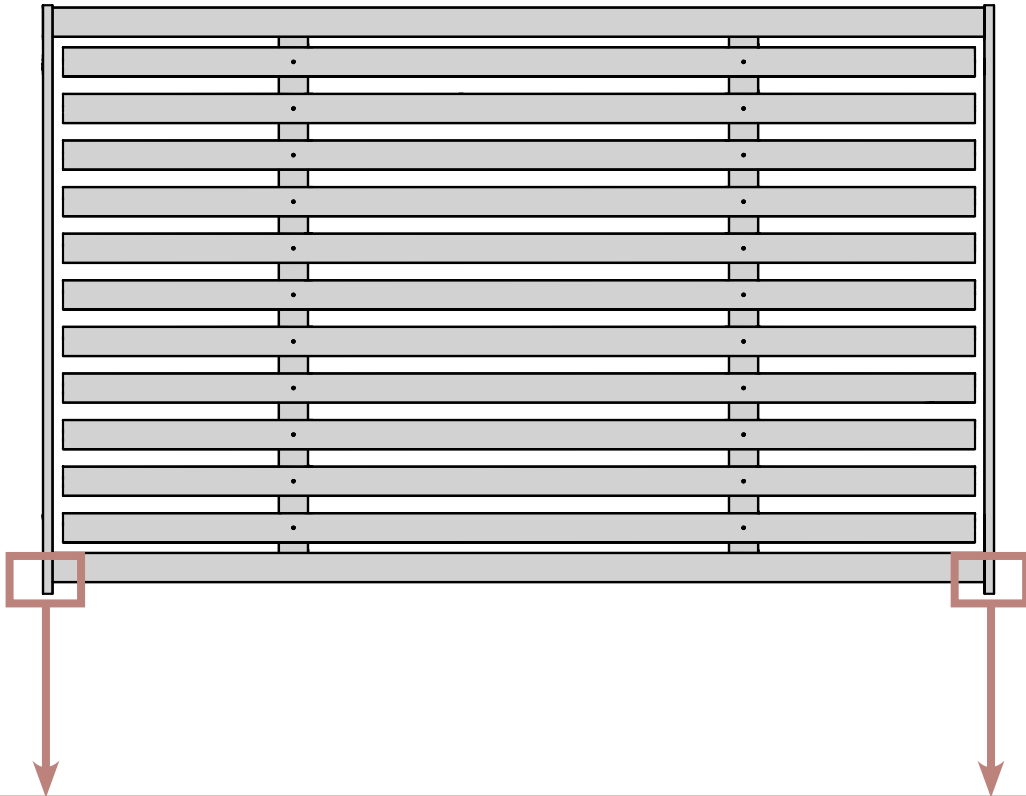
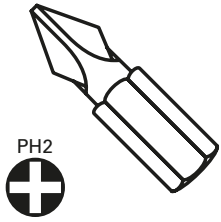

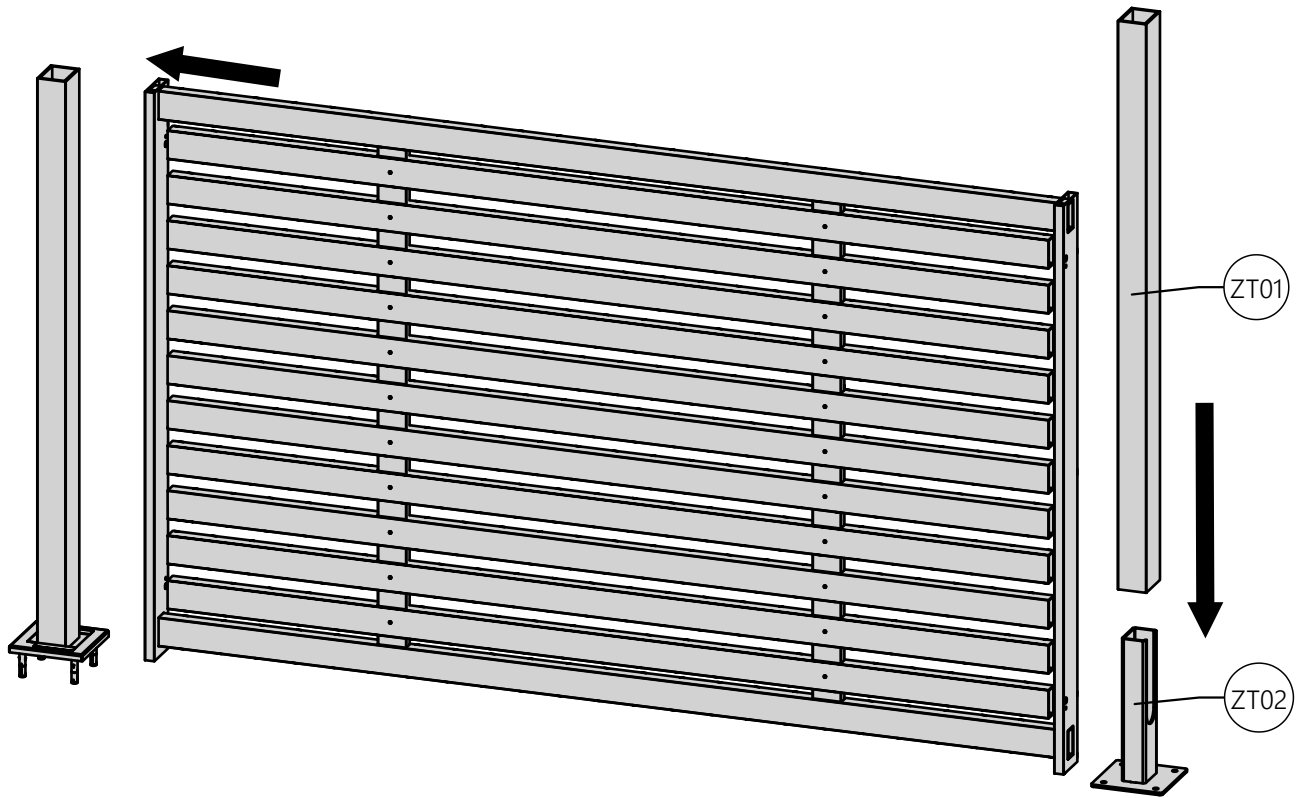
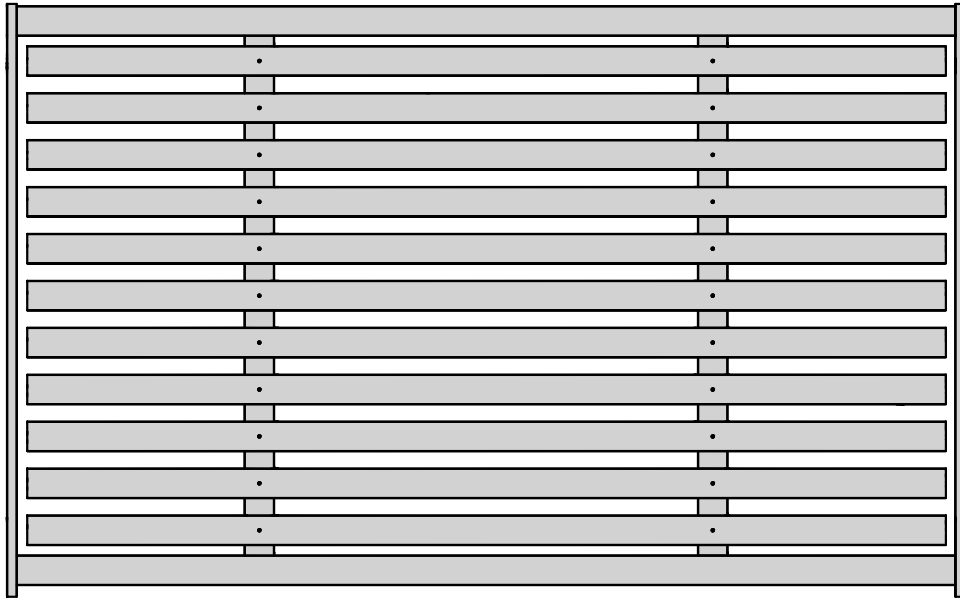

10

A

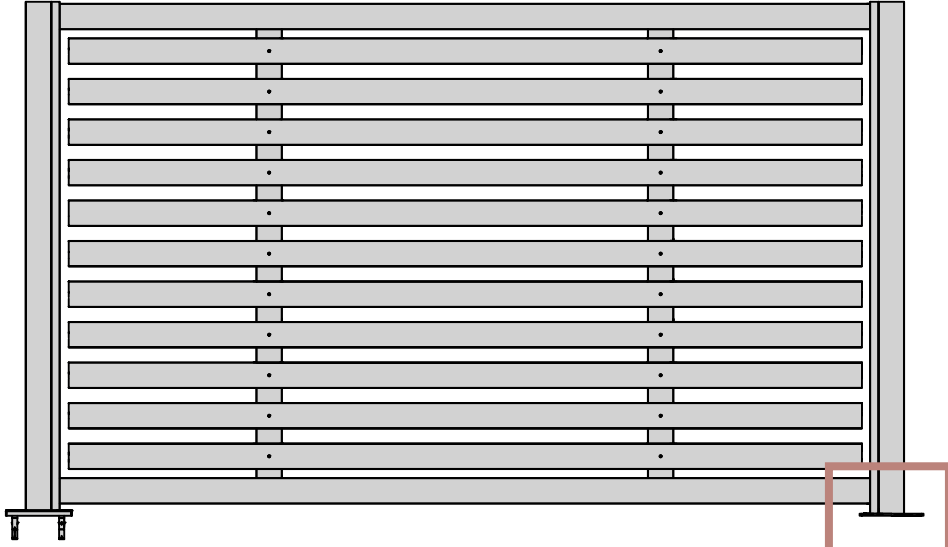
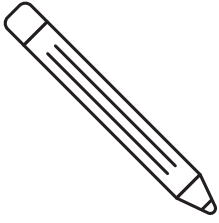

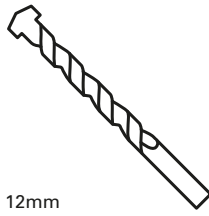
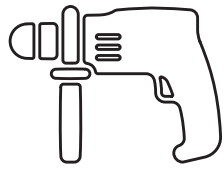

12mm

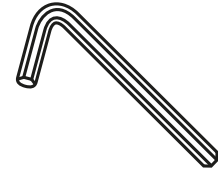
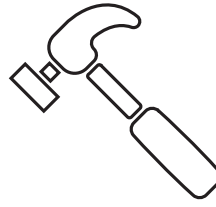

5mm

11

A

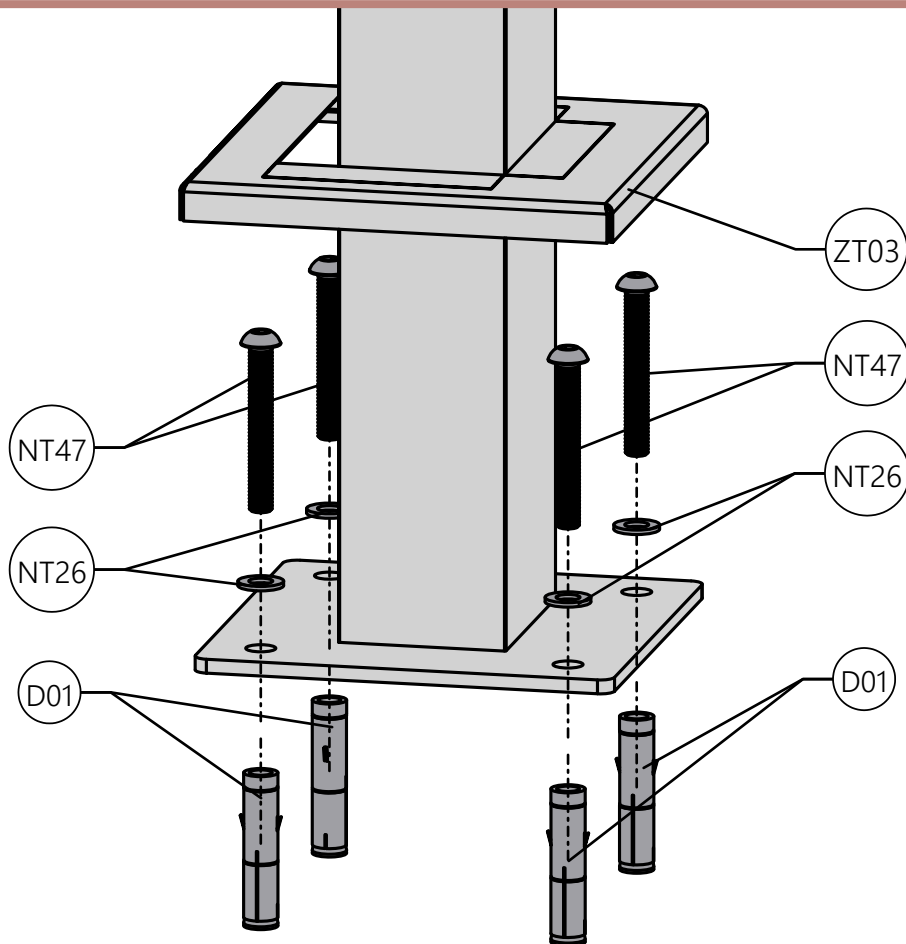
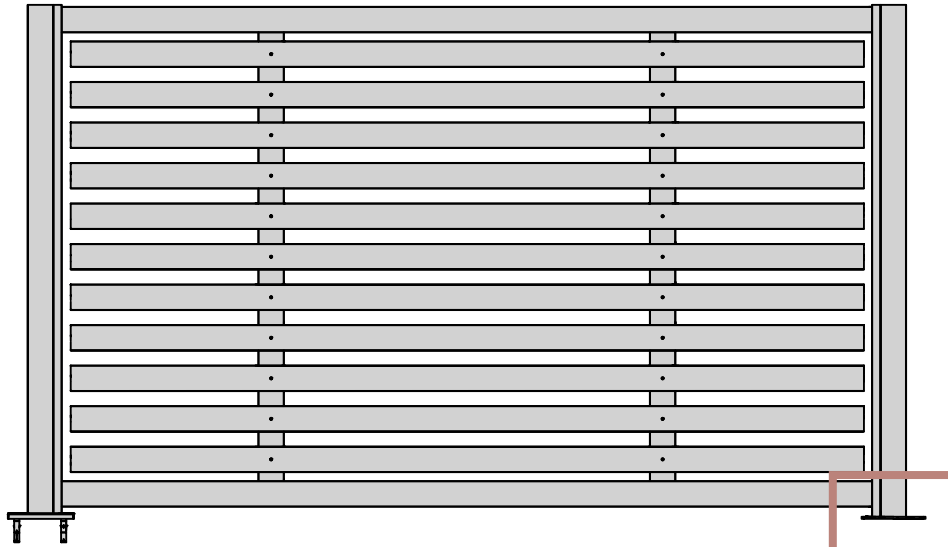

12

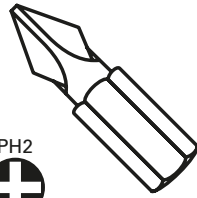

A

B

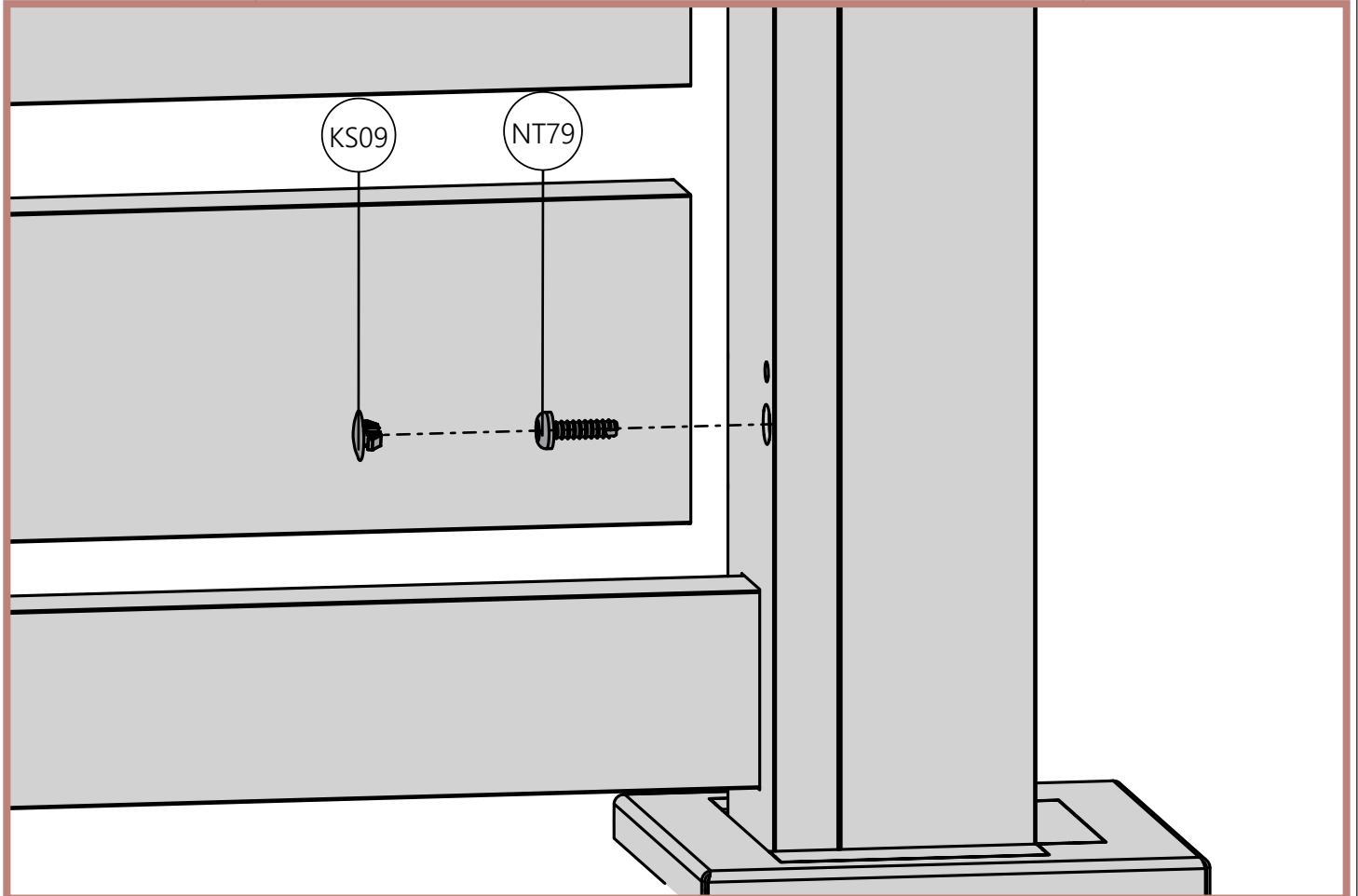
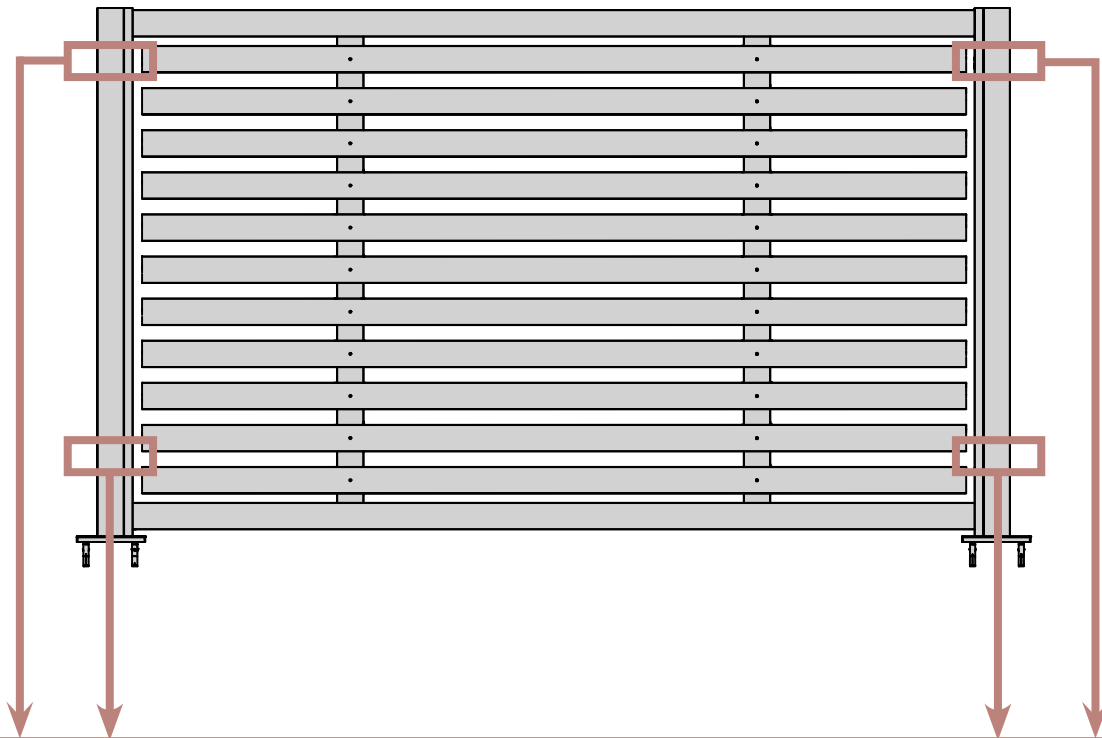

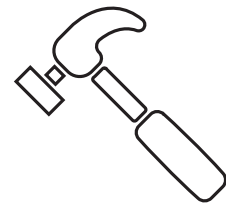
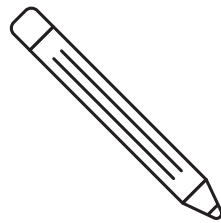
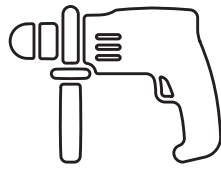
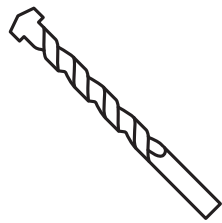

13

C

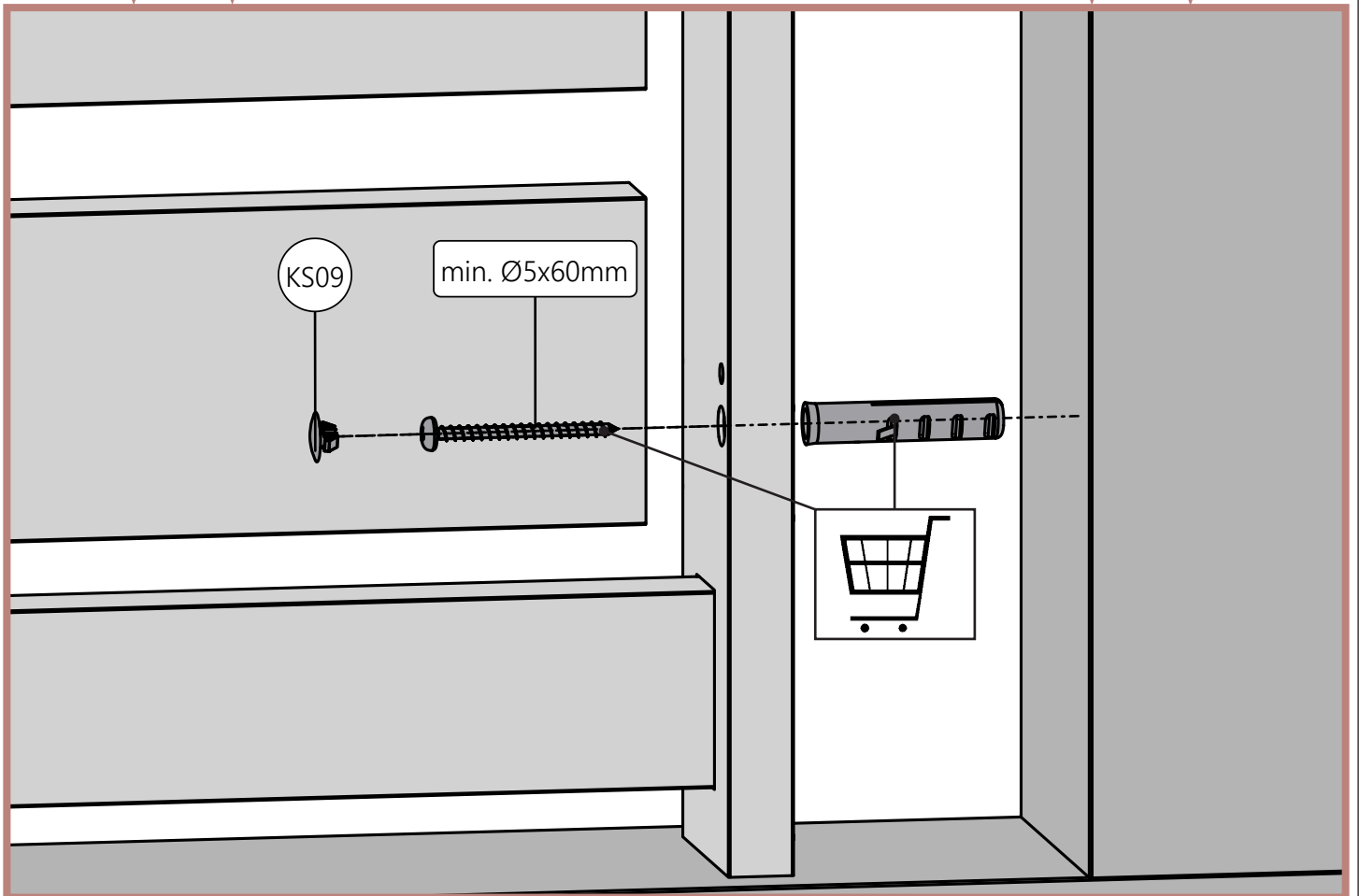
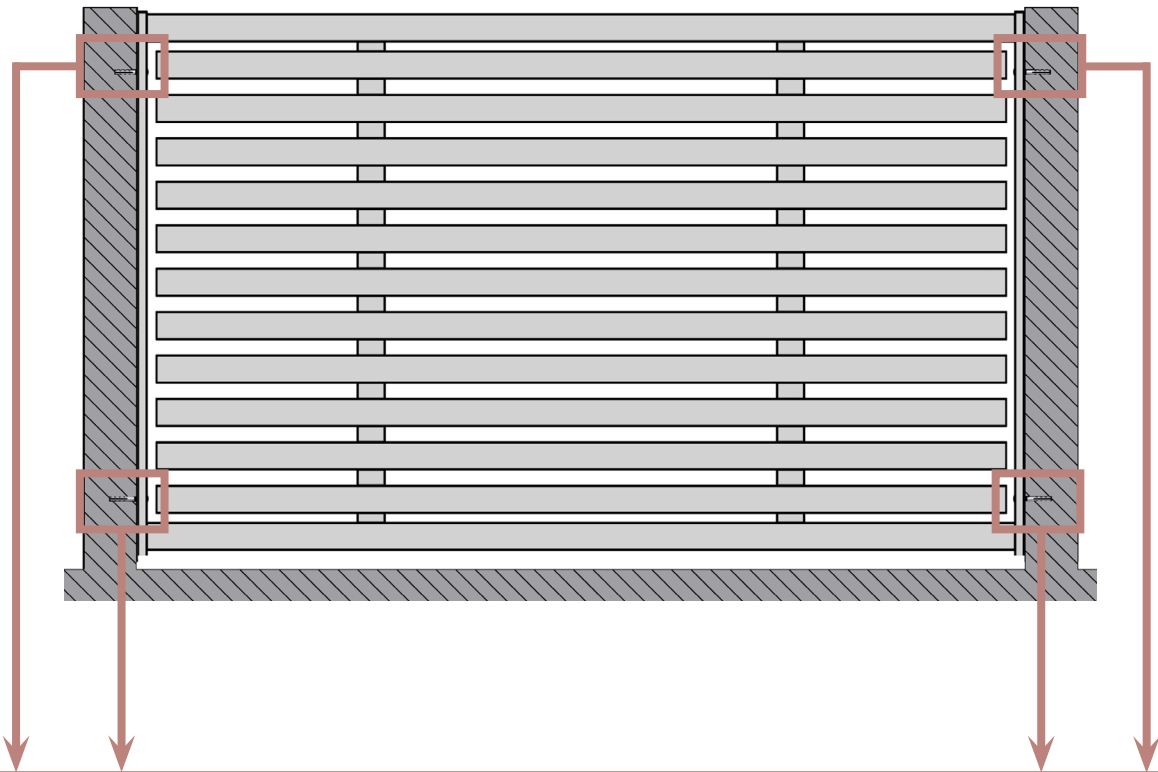

14

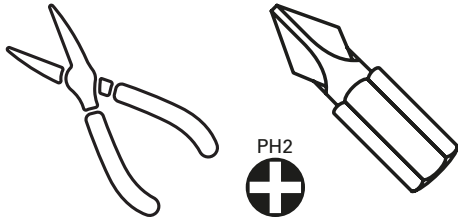

A

B

